

Operating Manual and
Programming Reference

PPM100
Partial Pressure Monitor



Certification

Stanford Research Systems certifies that this product met its published specifications at the time of shipment. Stanford Research Systems further certifies that its calibration measurements are traceable to the United States National Institute of Standards and Technology (NIST).

Warranty

This Stanford Research Systems product is warranted against defects in materials and workmanship for a period of one (1) year from the date of shipment.

Service

For warranty service or repair, this product must be returned to a Stanford Research Systems authorized service facility. Contact Stanford Research Systems or an authorized representative before returning this product for repair.

Information in this document is subject to change without notice.

Copyright © Stanford Research Systems, Inc., 2003. All rights reserved.

Stanford Research Systems, Inc.
1290-C Reamwood Avenue
Sunnyvale, California 94089
www.thinksrs.com

Printed in U.S.A.

Safety and Preparation For Use

CAREFULLY READ THE IMPORTANT SAFETY INSTRUCTIONS AND NOTES INCLUDED IN THIS SECTION BEFORE USING THE PPM100 PARTIAL PRESSURE MONITOR AND ITS ACCESSORIES. SAFETY PAYS!

Within this section, the word '**product**' specifically refers to the **PPM100 PARTIAL PRESSURE MONITOR and any of its accessories**.

Safety risks are associated with all research and production activities. Though long experience has proven high vacuum instrumentation to be remarkably safe, hazards are always associated with vacuum system operation. The most effective way to minimize risk to yourself and others is to read, and strictly follow, all safety instructions and warnings during the installation, operation and maintenance of the equipment connected to your vacuum system.

The intent of this section is to collect, in a single place, the most common risks associated to the installation, operation and maintenance of this product. The instructions are also repeated, with additional information, at the appropriate points throughout this manual.

This product has been designed with user-safety as a priority and has been proven to show reasonably safe operation provided it is installed, operated and serviced in strict accordance with all the safety instructions included in its manual

Safety Instructions and Warnings

- **SAFETY PAYS!** Safety instructions must be strictly followed during all stages of installation, operation and service of this product. Failure to comply with these precautions and warnings violates the safety standards expected of users of this product.
- Safety Instructions and Warnings, specific to the installation and operation of the Residual Gas Analyzer (RGA) Head, are included in the RGA100/200/300 Operating Manual and Programming Reference. Please read and strictly follow those detailed instructions during installation and operation of the RGA Head.
- If you have any doubts about how to use this product safely, contact Stanford Research Systems at the address listed in this manual.
- Retain these safety and operating instructions for future reference.
- Identify and adhere to all warnings posted on the product.
- Failure to comply with these instructions may result in serious personal injury, including death, as well as significant property damage.
- Due to the variety of vacuum system configurations and applications, it is impossible to account for all safety concerns that may arise during the installation, operation and maintenance of this product. Please contact the factory for any specific safety concerns not addressed directly by this manual.

- It is the installer's responsibility to ensure the safe operation of automated vacuum systems. Carefully check manual operation of the system and the setpoint programming instructions before switching to automatic operation.
- Provide for fail-safe operation wherever an equipment malfunction could lead to a hazardous situation.

Electrical Shock Risks

The most common risk associated with the operation of vacuum equipment is electrical shock.

- Dangerous voltages capable of causing injury and death are present during the operation of this product. **Do not remove the covers while the unit is plugged into a live outlet.**
- **Always operate the unit in its proper horizontal orientation.** Do not operate the unit on its side as foreign objects or liquids may enter through the ventilation slots, creating an unsafe condition.
- **Do not use this product if it has unauthorized modifications.** Unauthorized modifications may result in fire, electric shock and other hazards.
- Do not install substitute parts or perform any unauthorized modifications to this instrument.
- **The line fuse is internal to the instrument and may not be serviced by the user.** If the red 'Line' LED does not turn on when line power is provided, contact Stanford Research Systems.
- The PPM100 has a detachable, three-wire power cord for connection to the power source and to a protective ground. The exposed metal parts of the instrument are connected to the outlet ground to protect against electrical shock. **Always use an outlet which has a properly connected protective ground.** Consult with an electrician if necessary. Be aware that grounding this product does not assure proper grounding of the rest of the vacuum system.
- The most important safety measure required to eliminate electric shock risks is to **provide an earth ground to all conductive parts of the vacuum chamber, gauges and controllers.**
- GFCI (Ground Fault Circuit Interrupter) protected outlets are often available in production and laboratory environments, particularly in proximity to water sources. GFCI's are generally regarded as an important defense against electrocution. However, **the use of a GFCI in conjunction with PPM100's and vacuum systems must not be regarded as a substitute for proper grounding and careful system design.** GFCI's must also be tested regularly to verify their functionality. Always consult an electrician when in doubt.
- Do not use accessories not recommended in this manual as they may be hazardous.
- **Always turn off the power to the instrument before connecting any cable to the controller or to the RGA Head.**

- High-voltage ion-producing equipment such as a hot-cathode ionization gauge or an RGA can, under certain circumstances, provide sufficient electrical conduction via a plasma to couple a high voltage potential to the vacuum chamber walls. Any exposed conductive parts of a gauge, RGA probe, or vacuum chamber may attain high voltage potentials through this process if not properly grounded.
- All conductors in, on, or around the vacuum system that are exposed to potential high voltage electrical discharges must either be shielded at all times to protect personnel or must be connected to the system earth-ground at all times.
- All parts of a vacuum system utilized with this or any similar high voltage product must be maintained at earth ground for safe operation. There should be an **explicit heavy duty earth-ground connected to the vacuum chamber**. Check with an electrician if necessary. All electronic instrumentation must be connected to properly grounded electrical outlets and include a chassis grounding lug that must be tied to the common earth-ground of the vacuum system. Beware! Failure to safely ground your vacuum system can be fatal!
- The electrical insulation in this product may become less effective at preventing electrical shock after ten years of normal use (or even non-use). Products placed in harsh environments might deteriorate even faster. Inspect all electrical insulation periodically for signs of cracking and deterioration. Return the product to the factory for service if the insulation has become unsafe.
- To reduce the risk of fire and electrocution do not expose this product to rain or moisture. Be careful not to spill liquid of any kind onto or into the product.
- This product is intended for use only in a clean and dry laboratory environment. Operation in other environments may cause damage to the product and reduce the effectiveness of the safety features.
- Keep in mind that **O-ring seals without metal clamps or bolt connections can isolate big portions of a vacuum system from its safety ground**. Verify that the vacuum port to which any new component is mounted is electrically grounded. Use a ground lug on a flange bolt if necessary.
- Keep all electrical wiring in your vacuum system neatly organized and in good working conditions. Label and color-code all high voltage cables. Inspect all HV wires periodically for problems as part of your safety checkups.
- Use tie downs and cable channels to hold all electrical wiring in place (i.e. no dangling cables).
- Keep all electronic instrumentation neatly organized, and remove unconnected cables and connectors from the vacuum setup.
- If possible, rack mount your vacuum instrumentation.
- Only use instrumentation with high quality cables and connectors that properly shield all high voltage terminals. Eliminate homemade connections from your vacuum setups.
- High voltage cables from ion gauge controllers, ion guns, photomultiplier tubes, mass spectrometer probes, power supplies, etc , can be inadvertently damaged if pinched while tightening flange bolts. Keep all cables away from vacuum ports frequently opened to air.

- The voltages delivered by the RGA/PPM100 system can be lethal, particularly during electron bombardment degas. Do not touch any of its connection pins even if the gauge is off.
- Do not push objects of any kind into this product through openings as they may come in contact with dangerous voltage points or short out parts that could result in a fire or electric shock.
- Verify that the vacuum port to which the RGA Head is mounted is electrically grounded. It is essential for personnel safety as well as proper operation that **the RGA Head mounting flange be properly connected to the facility earth-ground**. Use a ground-lug on a flange bolt if necessary.
- **Perform regular electrical ground checkups** on your entire vacuum system, particularly if it is shared by multiple users running unrelated experiments. During a ground checkup carefully examine all vacuum system components: Are all exposed connectors and conductors on the vacuum chamber grounded? Are all ground connections properly connected to a solid earth (i.e. facility) ground? Some vacuum systems rely on water piping for the earth-ground connection. Proper ground connection can be easily lost by inadvertently inserting a plastic interconnect into the water lines. Refer to the step-by-step vacuum system grounding test procedure in Chapter 1 of this manual.
- Operation of this product with line voltages other than those accepted by the power supply can cause damage to the instrument and injury to personnel.

Burn Risks

Another common safety concern for vacuum system operators is burns.

- Filament based devices, such as Bayard-Alpert ionization gauges and RGAs, radiate heat to areas adjacent to the filament, sometimes making them too hot to touch.
- Do not touch hot-cathode Ionization Gauges and RGA's during degassing operation. Serious burns can occur.
- Acetone, toluene and isopropyl alcohol are highly flammable and should not be used near an open flame or energized electrical equipment.

Explosion Risks

Injury due to explosion is another important safety concern during the operation of a vacuum system and gas manifold system.

Explosion is possible in systems that are routinely cycled from vacuum to pressures above atmosphere and can be caused by many different reasons. Dangerous overpressure conditions can be established if a pressure regulator is set to the wrong value, the wrong gauge or gauge calibration is used for positive pressure measurements or even if a bad setpoint value is programmed into an automated process control setup. Explosions can also occur if flammable or explosive gases are exposed to hot elements such as the hot filaments of an RGA or the sensor wire of a Pirani gauge.

- Check that the right cylinders, with the right gases, are connected to the gas handling system before starting any process.
- **Check the pressure regulator settings** before starting any process.
- **Confirm that the right units were used** to program the setpoints of all automated process control channels.
- Install suitable devices that will limit the pressure to the level that the vacuum system, and its gas manifold, can safely withstand.
- Use pressure relief valves in the gas manifold and in the vacuum chamber, that will release pressure at a level considerably below that pressure which the system can withstand.
- **Do not use the product to measure the pressure of flammable, explosive, combustible or corrosive gases or mixtures of gases.** Turn off hot filament gauges during the exposure to flammable or explosive gases. Do not use this product to measure the pressure of unknown gases.
- Avoid enhanced Pirani and thermocouple gauges for pressure measurements in systems routinely pressurized above atmosphere (capacitance diaphragm gauges are much safer and recommended instead).
- If used improperly, Pirani gauges can supply incorrect pressure readings. For example, using the N₂ calibration of a convection-enhanced Pirani gauge (i.e. PG105 or PG105-UHV) to pressurize a vacuum system above 1 Torr with certain other gases can cause dangerously high pressures and may lead to explosion.
- **Do not use compression fittings for positive pressure applications.** Pirani, thermocouple and even capacitance diaphragm gauges mounted in this fashion can be forcefully ejected and injure anybody in their path.

Implosion Risks

The risk of implosion must also be considered in high vacuum systems using glass windows, glass tubulation and glass-envelope ionization gauges. Dropping a tool on a gauge under vacuum, or pulling on the cables can easily break the glass. The resulting implosion may then throw glass fragments around the room injuring personnel.

- Glass-tubulated ionization gauges should not be treated roughly or be bumped.
- Install the ion gauge cable on glass tubulated gauges before the gauge reaches vacuum pressures.
- **Stress relief all cables attached to glass tubulated ionization gauges.**
- Do not allow the gauge tube temperature to exceed 100° C in glass tubulated gauges. Sustained high temperatures can damage the tube, causing air leakage into the vacuum system and increasing the chances of dangerous implosion.
- Make all glass windows as small and thick as possible.
- Wherever feasible, replace glass-tubulated gauges with all-metal ones.
- Protect all glass components with internal vacuum with tape or metal shields.

References

For additional information on vacuum technology safety recommendations consult:

1. Charles F. Morrison, "Safety Hazard From Gas Discharge Interactions with the Bayard-Alpert Ionization Gauge", *J. Vac. Sci. Technol. A* 3 (5) (1985) 2032.
2. R. N. Peacock, "Safety and Health Considerations Related to Vacuum Gauging", *J. Vac. Sci. Technol. A* 11(4) (1993) 1627.
3. John T. Yates, Jr., "Experimental Innovations in Surface Science. A Guide to Practical Laboratory Methods and Instruments", Springer-Verlag, New York, Inc., 1998: (1) Section 238, p. 832, titled: 'Electrical Shocks in the Laboratory'; and (2) Section 239, p. 836, titled: 'Accidental Electrical Charging From Ionization Gauge'.
4. Gerardo Brucker, "Prevention is Key to Vacuum System Safety", *R&D Magazine*, February 2001, p. 57.
5. Donald M. Mattox, "Safety Aspects of Vacuum Processing", *Vacuum Technology and Coating Magazine*, March 2001, p. 22.

Contents

Safety and Preparation For Use	i
Contents	vii
Front Panel Overview	x
Touchscreen Display Overview	xi
Back Panel Overview	xii
Connector Pinouts	xiii
Specifications	xvii
Command List	xviii
Damage Requiring Service	xxi
Declaration of Contamination of Vacuum Equipment	xxiii

Chapter 1 Getting Started

Unpacking	1-3
Installing the PPM100 Controller	1-4
Installing and Connecting the RGA Head	1-6
Installing and Connecting Capacitance Manometers	1-8
PPM100 Quick Setup	1-12
Pressure Measurement	1-18
Pressure Display Screen	1-21
MassSpec Display	1-27
Leak Testing with the PPM100	1-29
Proper Grounding Test Procedure	1-31

Chapter 2 PPM100 Basics

PPM100 Overview	2-3
Front Panel	2-13
Back Panel	2-16
Maintenance and Service	2-22

Chapter 3 Displays and Menus

QuickKeys	3-5
Menu Buttons	3-8
Pressure Display	3-10
Monitor Display	3-15
Partial Pressure Setup Menu	3-16
Alarm Menu	3-19

Analog I/O Display 3-20

Analog I/O Setup Menu 3-23

Zero Manometer 3-26

MassSpec Display 3-27

Y Axis Menu 3-29

Logging Display 3-30

Logging Setup Menu 3-32

Chart Y Axis Menu 3-34

Chart X Axis Menu 3-35

Process Control Display 3-36

Edit Rules Menu 3-39

Edit Messages Menu 3-43

Main Menu 3-45

RGA Menu 3-46

Advanced Menu 3-48

Utilities Menu 3-50

Selftest 3-51

Remote Menu 3-52

RS-232 3-53

GPIB 3-54

Web 3-55

Web Control 3-57

USB 3-59

Screen Menu 3-60

Backlight Menu 3-62

Chapter 4 Analog I/O Ports

Analog I/O Ports (AN1-AN4) 4-3

Capacitance Manometers (CM1-CM4) 4-6

Compact Gauges 4-8

Chapter 5 Process Control

Process Control Warnings 5-3

Why Use Process Control? 5-4

Process Control Basics 5-5

Relay Connections 5-11

Digital I/O Module 5-17

Remote Control Inputs 5-22

Chapter 6 Programming

- Index of Commands 6-3**
- Alphabetical List of Commands 6-7**
- Introduction 6-11**
- Command Syntax 6-15**
- Partial Pressure / Analog Input Measurement Commands 6-17**
 - PPM Monitor Setup 6-21
 - Analog I/O Setup 6-24
- RGA Commands 6-25**
- Logging Commands 6-30**
 - Charting 6-33
- Mass Spectrum Display Commands 6-35**
- Process Control Commands 6-38**
- Backlight Commands 6-44**
- System Commands 6-45**
- Interface Commands 6-47**
- Status Reporting 6-49**
- Status Reporting Commands 6-52**
- Using USB 6-58**

Chapter 7 Embedded Web Server

- EWS Quick Start 7-3**
- Installing the EWS 7-5**
- Using the EWS 7-18**
- Networking Terms 7-32**

Chapter 8 Troubleshooting

- Warnings 8-3**
- Resetting the PPM100 8-3**
- Error Detection 8-4**
- PPM100 Error Messages 8-7**
- Basic Troubleshooting 8-9**
- Maintenance 8-13**
- Damage Requiring Service 8-14**

Front Panel Overview

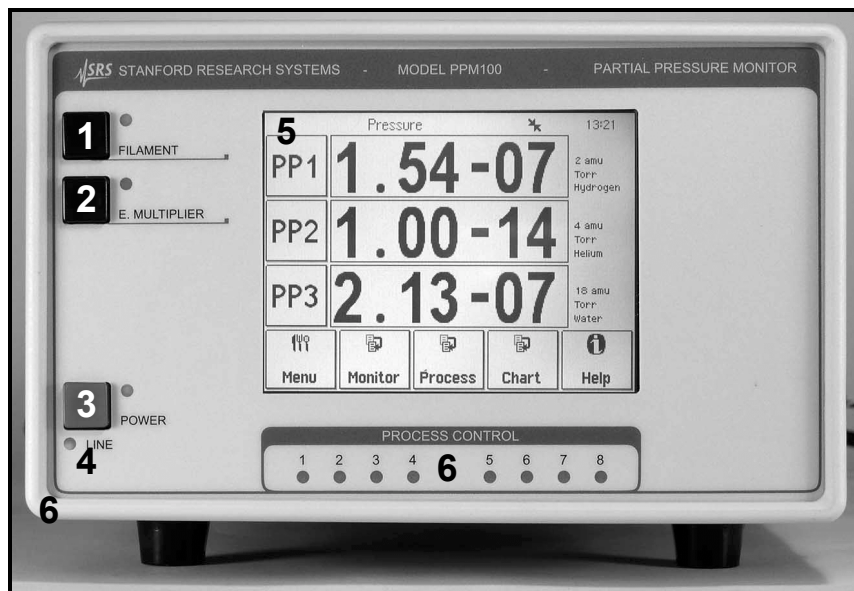
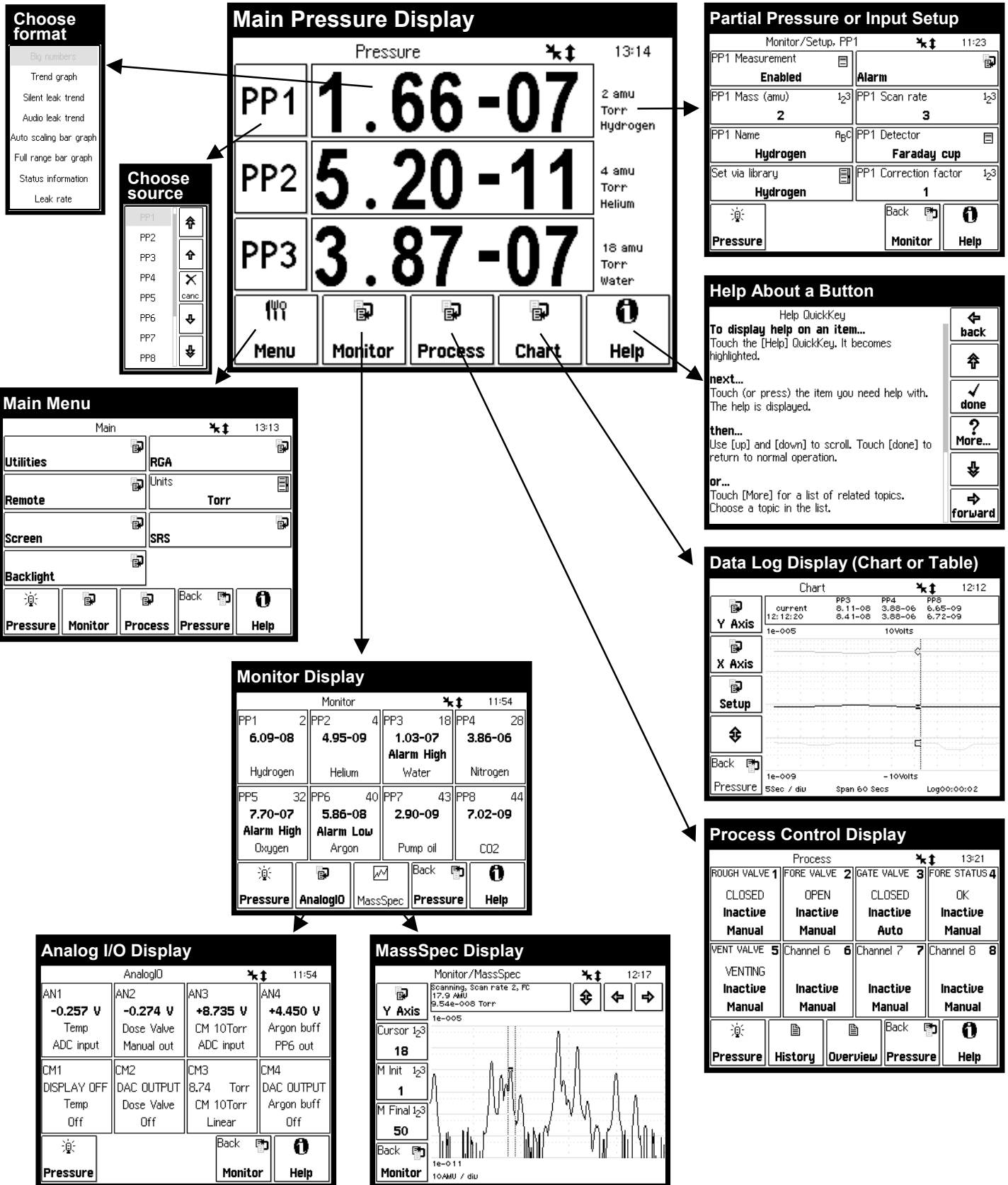

Figure i. PPM100 Front Panel.

1. FILAMENT BUTTON (Black w/green LED). Filament Emission power switch.
2. E. MULTIPLIER (Black w/green LED). Electron Multiplier power switch.
3. POWER Button (Red w/green LED). Controller power switch.
4. LINE LED (Red). Line voltage indicator.
5. LCD Display (w/touchscreen). Partial pressure and menu display area.
6. PROCESS CONTROL LEDs (green). Process control channel indicator lights.

Touchscreen Display Overview



Back Panel Overview

WARNING!

- Read the entire **Safety and Preparation for Use** section of this manual before using the PPM100.
- Read Chapter 1 for detailed instructions and safety information regarding the installation of the PPM100 and connection to the RGA Head.

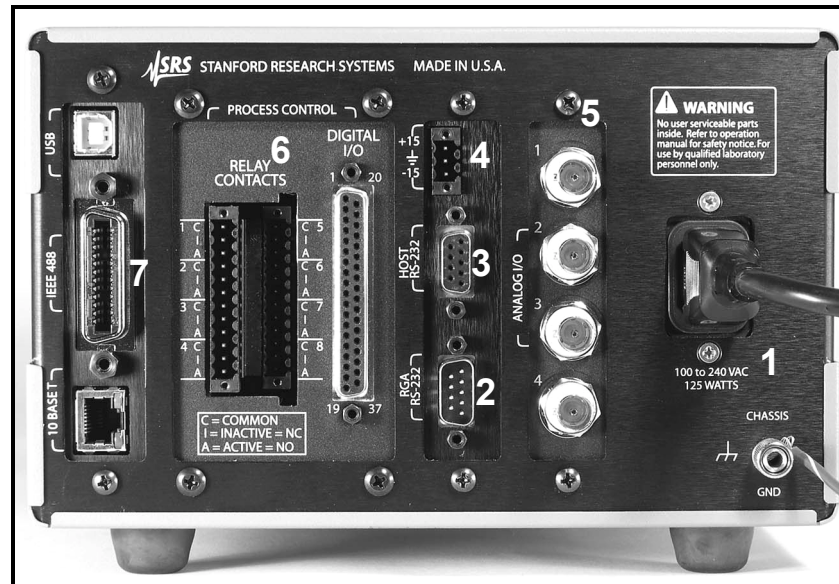

Figure ii. The PPM100 back panel.

1. Power - Power Entry Module and CHASSIS GND.
2. RGA RS-232 – RS-232 connection to RGA Head.
3. HOST RS-232 – RS-232 computer interface port.
4. Capacitance Manometer – ± 15 V AUX POWER.
5. Analog I/O - BNC Ports AN1-4
6. Process Control - RELAY CONTACTS and DIGITAL I/O.
7. Computer Interfaces - USB, GPIB (IEEE-488), and Ethernet 10BASE-T (Opt 01).

Connector Pinouts

WARNING!

- Read the entire **Safety and Preparation for Use** section of this manual before using the PPM100.
- Read Chapter 1 for detailed instructions and safety information regarding the installation of the PPM100 and connection to the RGA Head.

±15 V AUX Power Connector

Use this 3-pin, ±15 V (100 mA max), connector to provide electrical power to standard (i.e. non-heated) capacitance manometers.

Process Control

Relay Contacts

Use these two 12-Position Terminal Block Plugs to connect to the eight process control relays. All relays are SPDT, form C, 5A/250VAC/30VDC, resistive load only.

Process Action	Relay Common Connected to	Rear Panel Label
INACTIVE	Normally Closed pin (NC)	I
ACTIVE	Normally Open pin (NO)	A

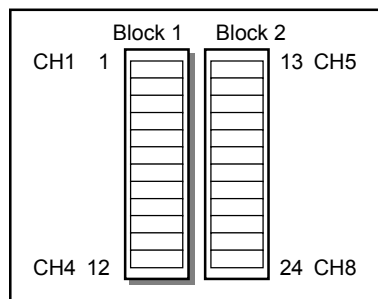

Figure iii. The 2 12-position terminal blocks for process relay connections.

Block	Pin	Process Channel	Process Control Label	Relay Pin
1	1	1	Common (C)	C
	2		Inactive (I)	NC
	3		Active (A)	NO
	4	2	Common (C)	C
	5		Inactive (I)	NC
	6		Active (A)	NO
	7	3	Common (C)	C
	8		Inactive (I)	NC
	9		Active (A)	NO

Block	Pin	Process Channel	Process Control Label	Relay Pin
1	10	4	Common (C)	C
	11		Inactive (I)	NC
	12		Active (A)	NO
2	13	5	Common (C)	C
	14		Inactive (I)	NC
	15		Active (A)	NO
	16	6	Common (C)	C
	17		Inactive (I)	NC
	18		Active (A)	NO
	19	7	Common (C)	C
	20		Inactive (I)	NC
	21		Active (A)	NO
	22	8	Common (C)	C
	23		Inactive (I)	NC
	24		Active (A)	NO

DIGITAL TTL I/O

Use the female DB37 port to connect to the (1) eight Process Control TTL Outputs, (2) eight Process Control TTL inputs and (3) seven Remote Control TTL inputs of the Process Control Board. A male DB37 connector is provided to facilitate connection to the controller.

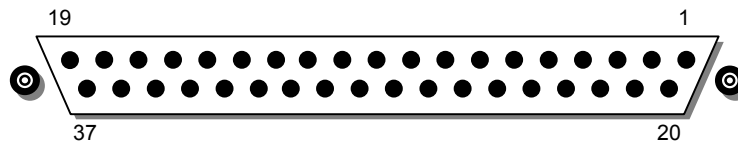

Figure iv. The PPM100 DB37 TTL I/O connector.

Module	Pin	Name	Description
	1	PPM100 Vcc	+5 V OUT
Remote Control TTL IN	2	ANODE COM	External User +5 V IN
	3	Not Used	
	4	Not Used	
	5	RGA_Degas	Edge trigger: ↓= Degas On, ↑=Degas Off
	6	RGA_FIL_Lockout	Level: LOW=RGA emission Off
	7	RGA_Key_Disable	Level: LOW=Disable front panel Keypad.
	8	Not Used	
	9	Not Used	
	10	Clear_Data_Log	Edge trigger: ↓=clear the data log
	11	RGA_Remote_Enable	Level: HIGH=Ignore RGA_Degas_On, RGA_FIL_On, RGA_EMULT_On pins.

Module	Pin	Name	Description
Remote Control TTL IN	12	RGA_FIL_On	Edge trigger: ↓=FIL ON, ↑=FIL Off
	13	Not Used	
	14	RGA_FP_Disable	Level: LOW= Disable Front Panel Controls
	15	PPM100 Vcc	+5 V OUT
Process Control TTL OUT	16	TTL_OUT_5	TTL OUT for Channel 5. LOW=ACTIVE
	17	TTL_OUT_6	TTL OUT for Channel 6. LOW=ACTIVE
	18	TTL_OUT_7	TTL OUT for Channel 7. LOW=ACTIVE
	19	TTL_OUT_8	TTL OUT for Channel 8. LOW=ACTIVE
Process Control TTL IN	20	ANODE COM	External User +5 V IN
	21	TTL_IN_1	TTL Input Signal for Channel 1. Active LOW
	22	TTL_IN_2	TTL Input Signal for Channel 2. Active LOW
	23	TTL_IN_3	TTL Input Signal for Channel 3. Active LOW
	24	TTL_IN_4	TTL Input Signal for Channel 4. Active LOW
	25	TTL_IN_5	TTL Input Signal for Channel 5. Active LOW
	26	TTL_IN_6	TTL Input Signal for Channel 6. Active LOW
	27	TTL_IN_7	TTL Input Signal for Channel 7. Active LOW
	28	TTL_IN_8	TTL Input Signal for Channel 8. Active LOW
	29	unused	
	30	PPM100 Ground	
	31	PPM100 Ground	
Process Control TTL OUT	32	COM_EMTR_REF	External User Ground
	33	COM_COLTR_PULLUP	External User +5 V IN
	34	TTL_OUT_1	TTL OUT for Channel 1. LOW=ACTIVE
	35	TTL_OUT_2	TTL OUT for Channel 2. LOW=ACTIVE
	36	TTL_OUT_3	TTL OUT for Channel 3. LOW=ACTIVE
	37	TTL_OUT_4	TTL OUT for Channel 4. LOW=ACTIVE

Note: ↓=HIGH-to-LOW, ↑=LOW-to-HIGH transition.

Process Control TTL OUT

These outputs are opto-isolated from the PPM100. For isolated operation of ALL outputs, connect pin 33 to the external +5 V supply and pin 32 to the external ground. For non-isolated operation of ALL outputs, connect pin 33 to PPM100 Vcc (pin 1 or 15) and pin 32 to PPM100 Ground (pin 30 or 31).

Process Control TTL IN

These inputs are opto-isolated from the PPM100. For isolated operation of ALL Process Control inputs, connect pins 2 and 20 to the external +5 V supply. Pull inputs to external ground for low inputs. For non-isolated operation of ALL Process Control inputs, connect pins 2 and 20 to PPM100 Vcc (pin 1 or 15) and pull inputs to PPM100 Ground (pin 30 or 31) for low inputs.

Remote Control TTL IN

These inputs are opto-isolated from the PPM100. For isolated operation of ALL Remote Control inputs, connect pins 2 and 20 to the external +5 V supply. Pull inputs to external ground for low inputs. For non-isolated operation of ALL Remote Control inputs, connect pins 2 and 20 to PPM100 Vcc (pin 1 or 15) and pull inputs to PPM100 Ground (pin 30 or 31) for low inputs.

RGA RS-232 Connector

The PPM100 includes a male DB9 connector for serial communication (RS-232, DTE) with the RGA Head.

Pin	Signal
1	unused
2	Receive data from RGA
3	Transmit data to RGA
4	unused
5	ground
6	unused
7	handshake from PPM
8	handshake from RGA
9	unused

Figure v. The PPM100 DB9 RGA RS-232 connector.

HOST RS-232 Connector

The PPM100 includes a female DB9 connector for serial communication (RS-232, DCE) with a host PC computer.

Pin	Signal
1	unused
2	Transmit data to Host
3	Receive data from Host
4	unused
5	ground
6	unused
7	handshake from Host
8	handshake from PPM
9	unused

Figure vi. The PPM100 DB9 RGA RS-232 connector.

Specifications

Specifications apply after 1 hour of warm-up

General

Interfaces	RS-232, USB, GPIB and Ethernet interface with embedded web server
Power	90 to 264 VAC, 47 to 63 Hz, 240 W
Operating temperature	0°C to 40°C, non-condensing Less than 90% humidity
Weight/Dimensions	15 lbs. / 8.5"x5.25"x16" (WHD)
Warranty	One year parts and labor

Display

Type	Back-lit, touchscreen LCD (4.7" diag)
Resolution	320 x 240 pixels
Modes	Numeric, bargraph, P vs. T
Units	Torr, mbar, bar, Pa and micron
Numeric resolution	3 digit mantissa plus exponent
Update rate	2 samples per second

Electrical (20°C to 30°C)

Analog I/O

Ports	4 configurable analog ports
Range	±12 Vdc
Resolution	14-bit (In), 12-bit (Out)
Update rate	2 Hz
Connector	BNC

Gauges

Capacitance Manometer

Number of gauges	Simultaneous readout of up to four capacitance manometers using the auxiliary inputs.
Auxiliary power output	±15 Vdc, 100 mA (for CM power)

Process Control

Number of channels	8 channels with programmable setpoint, polarity, hysteresis, delay, audio signal and text messages.
Input signals	Total pressure (CM gauge), partial pressure (RGA), voltage (analog I/O ports), time (internal clock), TTL and gauge status.
Output signals	Relay and TTL level
Relays	SPDT, form C, 5A/250VAC/30VDC, resistive load
TTL outputs	Active low, opto-isolated
Manual control	All channels can be operated from front panel.
Remote TTL control	8 opto-isolated TTL channels (Fil on/off, Degas on/off, Fil lockout, Control keypad lockout, data logging time reset, touchscreen enable/disable, remote enable/disable)

Index of Commands

Important

Always use the GPMU command at the start of a program to ensure that the desired units are in effect.

Use VERB 0 to set the RS-232 serial interface to terse mode for computer programs. Use VERB 1 to use verbose mode for serial console communications.

Variables

i, j, d, n, p	integers
x	real number
s, t	text strings

Partial Pressure and Analog Input Measurement

GPMU (?) {n} {s}	Pressure Units
GPBA (?) n {, p}	Data Bar Assign
GPDF (?) n {, i}	Display Format
GDAT ? p	Read Source Data
GDTX ? p	Read Source Data With Units
LRAT ? p	Read Leak Rate
LRCE (?) {n}	Leak Rate Coefficient
GDES (?) p {, s}	Gas Name/Port Location
GSTA ? p	Source Status
GSTT ? p	Source Status Time
OAQU ?	Read Monitor Alarm Status

PPM Monitor Setup

PCME (?) p {, i}	PPM Measurement Enable
MAME (?) p {, n}	PPM Mass
GDES (?) p {, s}	Gas Name/Port Location
SMCF (?) p {, x}	Gas Correction Factor
SVGL (?) p {, i}	Set Gas via Library
NFTM (?) p {, n}	PPM Scan Rate
HVTM (?) p {, i}	PPM Detector
OAEN (?) p {, i}	PPM Alarm Enable
OALH (?) p {, x}	Alarm Level High
OALL (?) p {, x}	Alarm Level Low
OABP (?) p {, i}	Alarm Beep

Analog Port Setup

GADM (?) n {, i}	I/O Mode
GDAS (?) n {, i}	DAC Source
GCMM (?) n {, i}	CM Mode
GDAV (?) n {, x}	Output Value
CMPX (?) n {, x}	CM PMax

RGA

MAXM ?	Read RGA Mass Range
RGAI ?	Read RGA Identification
EEEE (?) {n}	Electron Energy
IEEV (?) {i}	Ion Energy
FOPV (?) {n}	Focus Voltage
SCRA (?) {n}	Scan Rate
ECMA (?) {x}	Electron Current

CALL ?	Calibrate RGA Detectors
CEIV ?	Calibrate RGA Electrometer
DGAS (?) {i}	RGA Degas On/Off
EMIS (?) {i}	RGA Filament Emission On/Off
ENEM (?) {i}	RGA Electron Multiplier On/Off
EMBV (?) {n}	RGA Electron Multiplier Bias Voltage
EREQ (?) {i}	RGA Ionization Source
IRFE (?) {i}	RF7 Error Handling
LRER (?) {0}	Last RGA Error
PASS (?) {i}	RGA Pass Through
SYNC?	RGA SYNC

Logging

PLDS (?) {i}	Chart/Table Display
PLCL	Clear Data Log
PLGF ?	Read Data Log First
PLGN ?	Read Data Log Next
PLIN (?) {n}	Logging Interval
PLWT (?) {n}	Log Length
PLEN (?) {i}	Logging Enable
PLDD (?) {i}	Display Date
PLTR (?) {i}	TTL Reset Enable

Charting

LCPN (?) {x}	Chart/MassSpec Pmin
LCPX (?) {x}	Chart/MassSpec Pmax
LCVN (?) {x}	Vmin
LCVX (?) {x}	Vmax
LCSA	Autoscale Y-Axis
LCRG (?) {n}	Time Range
LCSF	Scale X-Axis to Full

Mass Spectrum Display

SCOK ?	Analog Scan OK
MENU d	Display Screen
SCMF (?) {n}	MassSpec Final Mass
SCMI (?) {n}	MassSpec Initial Mass
SCAN (?) {i}	Start/Stop Analog Scan
OSCC ?	MassSpec Complete
LCPN (?) {x}	Chart/MassSpec Pmin
LCPX (?) {x}	Chart/MassSpec Pmax
SYSA	Autoscale MassSpec Y-Axis
CTOM (?) {n}	Move MassSpec Cursor
MACB ?	Read MassSpec Mass
PACB ?	Read MassSpec Peak

Process Control

RDES (?) d {, s}	Channel Description
RLCL (?) d {, s}	Channel Active Message
RLOP (?) d {, s}	Channel Inactive Message
RBEP (?) d {, i}	Channel Beep
RMOD (?) d {, i}	Channel Mode
RSTA (?) d {, i}	Channel State
RAMS (?) d {, i}	Channel Input
RGOS (?) d {, i}	Gauge Off State
RTRP (?) d {, x}	Pressure Setpoint

xx Commands

RTRV (?) d {, x}	Voltage Setpoint
RPHY (?) d {, n}	Percent Hysteresis
RVHY (?) d {, x}	Voltage Hysteresis
RPOL (?) d {, i}	Setpoint Activation
RDEL (?) d {, n}	Setpoint Delay
RTCL (?) d {,n} {,s}	Activation Time
RTOP (?) d {,n} {,s}	Deactivation Time
RTIL (?) d {, i}	TTL Activation Level
TTL ?	Read TTL Inputs
RHGF ?	Read Process Log First
RHGN ?	Read Process Log Next
RHCL	Clear Process Log
RBAD ?	Relay Failure Status

Backlight

BLN (?) {i}	Backlight Saver Enable
BLIT (?) {i}	Backlight On/Off
BLOF (?) {n} {s}	Backlight Turn-Off Time
BLON (?) {n} {s}	Backlight Turn-On Time
BLTD (?) {n}	Backlight Delay

System

NAME (?) {s}	System Name
TIME (?) {s}	Time
DATE (?) {s}	Date
VOLC (?) {n}	Volume
MENU d	Display Screen
MESG (?) {s}	Message
DHWR ? d	Detect Hardware
*TST ?	Self-Test
FREV ?	Firmware Revision
VRDT ?	Firmware Build
SNUM?	Serial Number

Interface

VERB (?) {i}	Verbose RS-232
*IDN ?	Identification
*RST	Reset
WSEN (?) {i}	Web Server Enable

Status

*CLS	Clear Status
*PSC (?) {i}	Power-On Status Clear
*STB ? {i}	Read Serial Poll Status
*SRE (?) {i} {,j}	Serial Poll Enable
*ESR ? {i}	Read Standard Event Status
*ESE (?) {i} {,j}	Standard Event Enable
ERSW ? {i}	Read Error Status
ERSE (?) {i} {,j}	Error Status Enable
GSSW ? {i}	Read Gauge Status
GSSE (?) {i} {,j}	Gauge Status Enable
RSSW ? {i}	Read Process Status
RSSE (?) {i} {,j}	Process Status Enable

Damage Requiring Service

Caution

Do not use this product if it has unauthorized modifications. Unauthorized modifications may result in fire, electric shock and other hazards.

Do not use accessories not recommended in this manual as they may be hazardous.

Note

Within this section, the word 'product' specifically refers to the PPM100 Partial Pressure Monitor, any of its accessories, or any SRS manufactured RGA.

Contact the factory for instructions on how to return the instrument for authorized service and adjustment.

Service of this product, by Authorized Service Personnel only, may be required under any of the following conditions:

- Any cable or plug is damaged.
- The product does not operate properly even after strictly following the operating instructions.
- The product exhibits a distinct change in performance.
- A liquid has spilled inside the product.
- The product has been exposed to rain or water.
- An object has fallen into the product.
- The product has been dropped or the enclosure has been damaged.
- The product contains unauthorized modifications. Do not substitute parts or modify the product. No user-serviceable parts are inside the controller. All service and repair information in this manual is for the use of Authorized Service Personnel only.
- If the product is a vacuum Gauge or RGA, a Declaration of Contamination, describing the condition of the product and listing the gases it has been exposed to, must be submitted to Stanford Research Systems for review before a return authorization can be issued.
- The repair and/or service of products exposed to vacuum systems can only be carried out if a completed Declaration of Contamination has been submitted in advance. Stanford Research Systems reserves the right to refuse acceptance of vacuum equipment where the Declaration of Contamination has not been fully or correctly completed. SRS also reserves the right to deny return authorizations for any vacuum equipment that could potentially be harmful to the personnel carrying out the repair and service of the product.

Declaration of Contamination of Vacuum Equipment

The repair and/or service of vacuum equipment or components can only be carried out if a completed **Declaration of Contamination** has been submitted to Stanford Research Systems (SRS). The completed declaration must be reviewed by qualified personnel before a return authorization number (RMA#) can be issued. Contact SRS to request additional copies of this form or if you have any questions regarding the contents of this declaration.

- SRS reserves the right to refuse acceptance of vacuum equipment submitted for repair or maintenance work where the declaration has been omitted or has not been fully or correctly completed.
- SRS reserves the right to refuse to service any vacuum equipment which could potentially be harmful to the personnel carrying out the repair and service of the equipment.
- SRS will not accept any equipment which has been radioactively or explosively contaminated.
- SRS will not service any equipment that might contaminate its vacuum calibration equipment.

Description of equipment

Equipment type/model: _____

Serial No.: _____ Date of Purchase: _____

Reason for return (circle one): • Repair • Maintenance

Please describe symptoms and problems:

Equipment condition

Has the equipment been used ? (circle one) • Yes • No

Describe the operating environment the instrument was exposed to:

Declaration of Contamination of Vacuum Equipment (cont.)

Was any of the equipment exposed to potentially harmful substances? (circle one)

- No
- Yes.

Please attach list of all known harmful substances including chemical name and symbol, precautions associated with the substance and first aid measures in the event of accident.

Were any of the harmful substances:

- Radioactive? • Yes • No
- Toxic? • Yes • No
- Corrosive? • Yes • No
- Explosive? • Yes • No

Was the equipment decontaminated/cleaned before being shipped to SRS?

- Yes • No • Not Applicable

Legally Binding Declaration

I hereby declare that the information supplied on this form is complete and accurate. The dispatch of equipment will be in accordance with the appropriate regulations covering Packaging, Transportation and Labeling of Dangerous Substances.

Name (print): _____

Job Title: _____

Organization: _____

Address: _____

Telephone: _____ Fax: _____

Email: _____@_____

Legally binding signature: _____ Date: _____

SRS Use Only.
RMA#: _____
Form reviewed by:
Signature _____
Name/Initials _____
Date: _____

Chapter 1

Getting Started

This chapter provides instructions for

- unpacking, checking and installing the PPM100 Partial Pressure Monitor
- connecting the cabling between the controller and the RGA Head
- setting up the controller parameters
- measuring partial pressures, total pressures (i.e. capacitance manometers) and voltages

In This Chapter

Unpacking	1-3	Pressure Measurement	1-18
Before You Open the Box	1-3	Warm-up times	1-18
Checklist	1-3	Partial Pressure Measurements (PP1-PP8)	1-18
Standard Equipment/Supplies	1-3	Capacitance Manometer Readings (CM1-CM4)	1-20
Optional Equipment	1-3	Pressure Display Screen	1-21
Installing the PPM100 Controller	1-4	Data Display Options	1-22
Mounting Options	1-4	Big Numbers	1-22
Line Power Connection	1-4	Trend Graph	1-23
Grounding	1-5	Silent/Audio Leak Trend Graph	1-23
Installing and Connecting the RGA Head	1-6	Auto Scaling Bar Graph	1-24
Installing the RGA Head	1-6	Full Range Bar Graph	1-24
Connecting to the RGA Head	1-6	Leak Rate	1-24
Installing and Connecting Capacitance Manometers	1-8	Status Information	1-25
Installing a capacitance manometer	1-8	Pressure Units	1-25
Connecting a Capacitance Manometer	1-9	Logging	1-26
Grounding	1-9	MassSpec Display	1-27
Pressure Signal Connection	1-10	Using the Display	1-28
Power Connection	1-10	Leak Testing with the PPM100	1-29
PPM100 Quick Setup	1-12	Proper Grounding Test Procedure	1-31
Power-On Procedure	1-12	Ground Test Procedure:	1-32
Connection Status	1-13		
Reset	1-13		
Partial Pressure Setup	1-14		
Partial Pressure Parameters	1-15		
Capacitance Manometer (CM1-4) Setup	1-16		

Unpacking

Before You Open the Box

Read the entire **Safety and Preparation for Use** section of this manual before starting any installation procedure.

Take a moment at this time to read (or review) the installation, operation and safety instructions of the SRS RGA100/200/300 Head.

Read and strictly follow all installation instructions in this chapter to ensure that the performance of this instrument is not compromised by an incorrect installation.

Read and follow all safety and warning instructions in this manual to minimize the risk of injury and death to yourself and others.

DO NOT power up the instrument until specifically directed by the instructions.

Checklist

Open the box(es) and inspect all components of the PPM100 system.

Report any damage to Stanford Research Systems immediately.

Compare the contents of the shipping boxes against your original order and the checklist below. Report any discrepancies to Stanford Research Systems immediately.

Standard Equipment/Supplies

- PPM100 Partial Pressure Monitor Box.
- Power cord.
- Operating Manual and Programming Reference.
- Three (3) Position Terminal Block Plug for AUX ± 15 Vdc output.
- Process Control Module. Preinstalled at the factory.
Includes: (1) one DB37 Digital I/O Connector (male)
(2) two 12-position Terminal Block Plugs for relay connections.
- GPIB/USB Computer Interface. Preinstalled at the factory.
- Web Interface. Preinstalled at the factory.

Optional Equipment

- Rack Mount Shelf, for up to two PPM100's (SRS# O100IGRM).
- SRS RGA100/200/300 Mass Spectrometer. (Includes DB9-DB9 cable for serial connection to PPM100.)

Installing the PPM100 Controller

Read the entire **Safety and Preparation for Use** section of this manual before starting any installation procedure.

Mounting Options

The PPM100 offers a variety of mounting options to fit your needs: (1) bench-top, (2) half-rack and (3) two units, side-by-side, in full-rack width.

Place the controller in a secure place on your bench-top or mount it into an equipment rack tray (SRS# O100IGRM, compatible w/standard 19 inch rack). In all cases, provide adequate ventilation for the control unit to dissipate heat - *»1 inch clearance around the side ventilation slots is recommended.* Allow at least 6 inches at the back of the controller for cable routing. Do not mount the unit above other equipment that generates excessive heat. The PPM100 is designed to operate over the range 0-40°C. Ambient temperatures above that value may damage the instrument.

Line Power Connection

Line Voltage Selection

The PPM100 operates from a 100 V, 120 V, 220 V, or 240 V nominal AC power source having a line frequency of 50 or 60 Hz.

Use the power entry module on the back panel of the PPM100 to power the unit from a wall outlet. Make sure that suitable power is available for the controller: 100-240 Vac, 50-60 Hz, 500 W. Use the three-wire power cord, provided by Stanford Research Systems, to connect the PPM100 to a **properly grounded** wall outlet. Contact Stanford Research Systems if a power cord compatible with your outlets was not included with your unit.

The connection of LINE power to the box is clearly indicated by a lighted LINE LED (red) located below the POWER button at the lower left corner of the front panel.

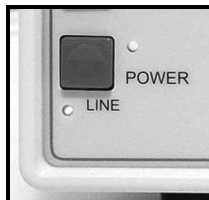

Figure 1-1. LINE LED below the POWER button indicates that Line Power is **connected**.

WARNING!

Do not switch on the power yet! Wait until instructed to do so later. Make sure that the green POWER LED is off.

Grounding

Connect a heavy duty ground wire, #12 AWG or larger, from the CHASSIS GND lug on the back of the PPM100 **directly to your facility earth ground**. This will provide an earth ground for the PPM100 in case the power cable is not in place. *Do not connect the CHASSIS GND lug to the vacuum system or other electrical component.* Connect it directly to the facility grounding system such as a grounded outlet box or a grounded copper water supply line. Do not rely on small metal water lines to ground a component. Get professional help from an experienced electrician if necessary.

WARNINGS!

- Connecting the power cord to a properly grounded outlet is necessary, but not sufficient with this (or any similar) high voltage producing vacuum equipment.
- Grounding the PPM100 does not and cannot guarantee that other components of the vacuum system are all maintained at earth ground.
- Perform a **Proper Grounding Test** on your vacuum system (described at the end of this chapter) if uncertain about the electrical safety of your vacuum setup. Consult an experienced electrician if necessary.



Figure 1-2. Power and chassis-ground connection on the back of the PPM100 controller.
 1. Power entry module with power cord (connected to grounded wall outlet on the other end),
 2. CHASSIS GND lug with heavy gauge ground wire connected **directly** to facility earth ground.

Installing and Connecting the RGA Head

When properly connected to an SRS RGA Head, the PPM100 controller can monitor and display partial pressure measurements for up to 8 independent component gases. A Scan Display mode is also available to graph RGA Mass Spectra directly on the front panel of the instrument.

All communications between the PPM100 and the SRS RGA Head take place over an RS-232 serial interface connection. No power is delivered to the RGA Head from the PPM100 controller.

Installing the RGA Head

WARNINGS!

- Read the entire **Safety and Preparation for Use** section of the RGA Manual before starting the SRS RGA Head installation procedure.
- Read and strictly follow all RGA installation instructions in the RGA Manual to ensure that the performance of the instrument is not compromised by an incorrect installation.
- PPM100 is not compatible with any third-party residual gas analyzers.

An RGA100/200/300 Head must be mounted on the vacuum system, and properly pumped down ($P < 10^{-4}$ Torr), before connection to the PPM100 box can be completed and partial pressure readings can be displayed.

If not already in place, unpack and mount the SRS RGA Head on your vacuum system at this time and pump the vacuum chamber down to a compatible base pressure (i.e. below 10^{-4} Torr.)

If possible, confirm proper operation of the SRS RGA Head before connecting to the PPM100 - use the RGA Windows program (included) and a host computer connected directly to the RGA's serial communication port to test the mass spectrometer by itself.

Connecting to the RGA Head

WARNINGS!

- Connect the interface cable to the PPM100 controller first, *before* establishing a connection to the RGA Head.
- **DO NOT** switch the controller power on until instructed to do so.
- *The RGA Head chassis must be properly grounded* during operation to assure operator safety.
- Cables, once installed, must be secured to provide strain relief for the gauge pins.

This section describes the electrical connection between the RGA Head and the PPM100 controller. A one-cable serial communication connection between the two devices is all that is required to complete this connection. No power is delivered to the SRS RGA Head from the PPM100 box.

Locate the DB9-DB9 Serial Communication Cable included in the RGA package. Connect the female cable connector to the RGA RS-232 DB9 Connector on the back plane of the PPM100 controller. Connect the other end of the cable to the female DB9 connector, labeled RS-232/DCE/28.8k, on the back panel of the RGA's electronic control unit (ECU).

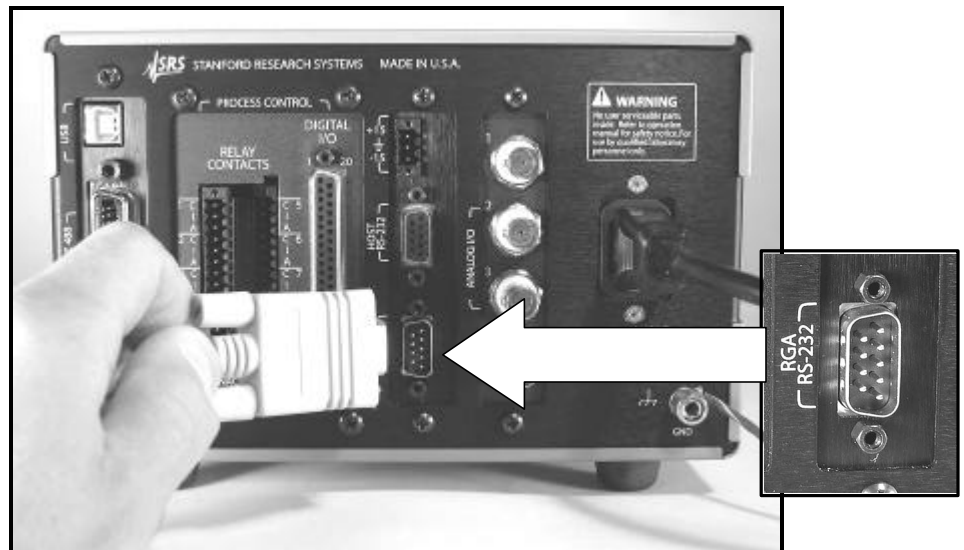

Figure 1-3. RGA-RS-232 Connector on the back of the PPM100.

Installing and Connecting Capacitance Manometers

Capacitance manometers are also called Capacitance Diaphragm Gauges.

The PPM100 can display pressure as measured from standard capacitance manometers (CMs). Up to four independent CM readings can be monitored simultaneously using the four ANALOG I/O ports located on the back panel of the controller. The PPM100 also supplies auxiliary power (± 15 Vdc, 100 mA) sufficient to operate a pair of standard (i.e. non-heated) capacitance manometers. The PPM100 precisely measures the 0 to 10 Vdc linear output signal from the CM to determine pressure. Full-scale ranges up to 1000 Torr are supported by the controller.

CMs may be ordered from several commercial sources. The specifications of CMs should always be compared with the PPM100 specifications before a connection is established. Stanford Research Systems is not responsible for changes in design or specifications of third-party products that might render them incompatible with the PPM100 controller.

Installing a capacitance manometer

WARNINGS!

- Read the entire **Safety and Preparation for Use** section of this manual before starting any installation procedure.
- Consult your gauge manufacturer for specific gauge installation requirements and Stanford Research Systems if uncertain about the compatibility of PPM100 with your third-party capacitance manometer

It is generally recommended CMs be mounted with the inlet port pointing vertically downward. Although the gauge can be mounted in any orientation, mounting it as suggested allows any foreign matter entering the pressure port to fall away from the diaphragm. Isolate the unit from vibration as much as possible. While not susceptible to gas damping, the diaphragm may become susceptible to resonance. The low range transducers (≤ 1 Torr) are particularly sensitive and should be carefully isolated from any vibrations. Isolate the vibration through the cable as well as through the port.

WARNING!

Do not connect a capacitance manometer gauge to the PPM100 until instructed to do so later in this chapter.

Connecting a Capacitance Manometer

WARNINGS!

- Connect all gauge signal cables to the PPM100 controller first, *before* establishing a connection to the gauge heads.
- **DO NOT** switch the controller power on until instructed to do so.
- *The gauge chassis must be properly grounded* during operation to assure operator safety.
- Cables, once installed, must be secured to provide strain relief for the gauge pins.

This section describes the electrical connection of Capacitance Manometers (CM) to the PPM100 controller. Capacitance Manometers are also known as Capacitance Diaphragm Gauges. Up to four independent CM readings can be monitored, logged and displayed, simultaneously. Full-scale ranges up to 1000 Torr are supported by the controller software.

Unfortunately, there are a variety of conventions for connecting CMs. Consult your installation and operation manuals for gauge-specific information including connector type, pin assignments, electrical specifications, cable requirements and grounding recommendations.

In many cases, pin assignments are conveniently silk-screened on the gauge casing close to the electrical connector. *Be prepared to manufacture your own custom cables to interface CMs to the PPM100 controller.*

IMPORTANT!

General guidelines for the manufacturing of generic interface cables are often listed in the CM manual, or can be obtained directly from the gauge manufacturer.

Standard CMs require three basic connection steps:

- Grounding
- Pressure Signal Connection
- Power Connection

Grounding

The gauge chassis must be properly grounded during operation to assure operator safety. Most CMs feature a chassis grounding lug that must be directly connected to the facility ground by a #12 AWG copper wire. If necessary, use a ground lug on a flange bolt, or a metal hose clamp on the sensor port, to establish a dedicated connection to the facility ground.

IMPORTANT!

Consult the CM's manual for gauge specific grounding requirements.

Pressure Signal Connection

To read CM pressures, the Pressure Output Signal must be connected to one of the four ANALOG I/O ports - BNC connectors labeled '1' through '4' on the back panel. Identify the two pins assigned to the pressure output signal on the gauge's interface connector (typically labeled signal out (+) and signal common (-)). Construct a cable from these pins to a BNC connector, center pin connected to signal out (+) and outer shield connected to signal common (-). Other names for the signal pins are: PRESS OUT/OUTPUT RTN, Pressure Signal Output/Pressure Signal Output Return, SIGN OUT/SIGN COM, etc.

Power Connection

For added convenience, the PPM100 also includes an auxiliary ± 15 Vdc (100 mA) CM Power connector (3-position terminal block) on its back panel. This output is usually sufficient for the simultaneous operation of a pair of standard gauges (i.e. non-heated, ± 15 Vdc, 35 mA typ.). Additional gauges or heated gauges will generally require help from an external source of power.

IMPORTANT!

Consult your CM manual or contact its manufacturer directly if you are uncertain about the power requirements of your gauges. Consult Stanford Research systems if uncertain about the compatibility of your CM(s) with the PPM100 controller.

Identify the three pins assigned to the ± 15 Vdc power connection (typically labeled -15 VDC, +15 VDC, and Power Return) and use three wires to connect the gauge to the auxiliary ± 15 VDC, 3-position, terminal block located on the back of the controller.

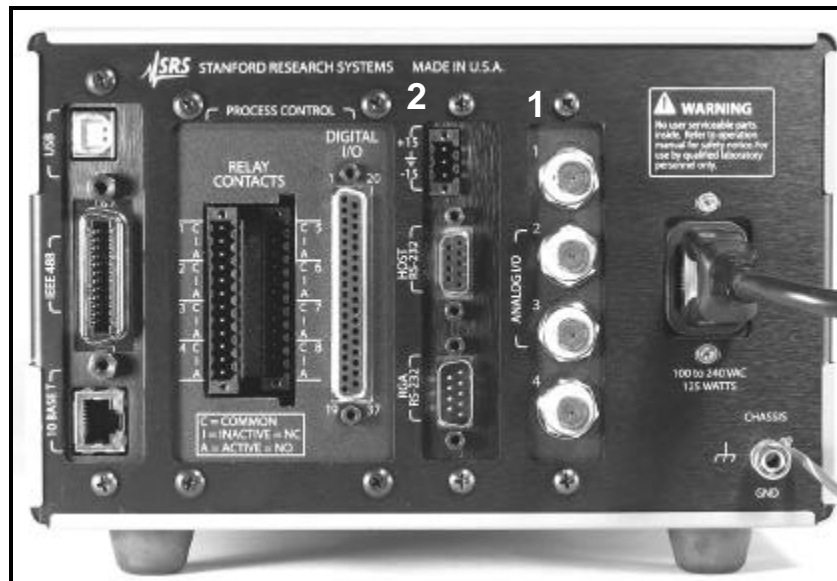

Figure 1-4. Capacitance Manometer Connection Ports.
1. Signal - Four ANALOG I/O BNC Ports. 2. Power - 3-position, terminal block.

Recommendation

Heated CMs often include additional pin connections assigned to heater status signals such as: 1. At Temperature Status/At Temperature Status Return pair and, 2. Heater Failure Status/ Heater Failure Status Return pair. In many cases these pin pairs act as semiconductor switches and their contact signals can be interfaced to the Process Control ports and used to trigger events in response to heater failure. This can be used to assure the reliability of your CM gauges at all times, and to protect delicate and expensive components sensitive to inaccurate pressure readings. Consult your gauge manual for availability of these options in your gauge heads.

PPM100 Quick Setup

This section describes the setup steps required to prepare the PPM100 for accurate partial and total pressure measurements with a Residual Gas Analyzer and (up to four) capacitance manometer gauges.

The steps in this section assume:

- ❑ The PPM100 box has been properly installed and grounded.
- ❑ Line power is connected to the controller (LINE LED on).
- ❑ The controller is turned off (POWER LED off)
- ❑ An SRS RGA Head and a capacitance manometer (ANALOG I/O 1 = CM1 port) are connected to the controller.
- ❑ Power is being delivered to the capacitance manometer.
- ❑ The RGA Head is turned off (POWER LED Off)
- ❑ All gauges are (1) mounted on the vacuum system, (2) properly grounded, (3) known to be compatible with the controller, and (4) safely connected to your PPM100 using Stanford Research System's cables (except for CMs).
- ❑ The RGA probe is exposed to a high vacuum environment with a known pressure $< 10^{-4}$ Torr, and the gas composition is either: air, nitrogen or residual gas (i.e. typical base pressure composition of a clean high vacuum system).
- ❑ You are reasonably familiar with the general theory of operation of mass spectrometers and capacitance manometers
- ❑ The Relay and Logic Process Control ports (if available) are not physically connected to any devices or in a safe MANUAL mode status.
- ❑ The Remote Control TTL inputs are not connected or disabled.
- ❑ Manual RGA operation - i.e. the controller is not under the control of an external computer via one of its interfaces (RS-232, GPIB, USB or web).

Power-On Procedure

Power-up the RGA Head. Flip the power switch located on the back plane of the RGA's ECU. The Green POWER LED turns on, and a brief Power-on Self-Test procedure is executed.

Power-up the PPM100 controller. Press the red POWER button located at the lower left corner of the front panel. The green POWER LED turns on, a brief Power-On Self-Test procedure is executed, and the Pressure Display Screen is displayed on the touch-screen LCD.

For all new units (i.e. straight out of the shipping box) the Pressure Display Screen, preset at the factory, includes: (1) three Data Bars, corresponding to partial pressure measurements PP1 (gas: Hydrogen, mass: 2 amu), PP2 (gas: Helium, mass: 4 amu) and

PP3 (gas: Water, mass: 18 amu) [top to bottom], plus (2) [Menu], [Monitor], [Process], [Chart], and [Help] QuickKeys lined up along the bottom of the screen (left to right.)

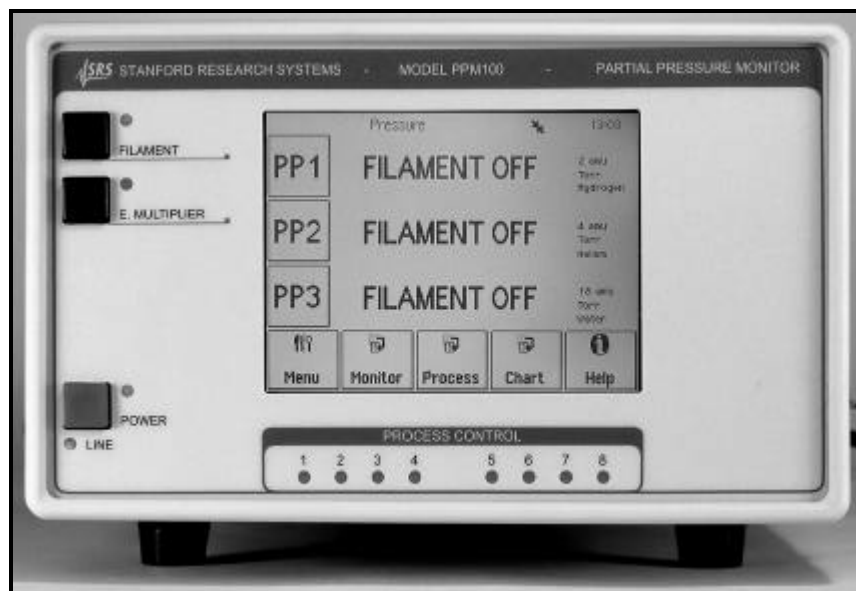



Figure 1-5. PPM100 Pressure Display Screen with factory default PP1, PP2 and PP3 Data Bars.

Connection Status

The status of the RS-232 connection between the PPM100 Controller and the RGA Head is indicated with an icon located near the upper right corner of the PPM100 screen.

A CONNECTED icon  indicates that a fully functional RS-232 link is present between the RGA Head and the PPM100 Controller.

An UNCONNECTED icon  indicates that the PPM100 has failed to detect a connection to the RGA Head. Consult Chapter 8 Troubleshooting, if this icon is present.

Reset

If your Pressure Display Screen does not appear like the one in Figure 1-5 at this point, it is possible to force the PPM100 to revert to its factory-preset settings by holding down the E. MULTIPLIER button during the Power-On procedure. However, keep in mind that this will also revert many other important settings of the instrument to factory default values (you might lose some important setup information). Holding down the E. MULTIPLIER Button should not be required for new instruments being powered right out of the shipping box.

The PP1, PP2 and PP3 Data Bars of your PPM100 should display a "FILAMENT OFF" message at this time - the RGA Filament is not yet activated.

If "NO RGA" is displayed, consult Chapter 8 Troubleshooting for diagnostic procedures related to the RS-232 connection between the RGA Head and the PPM100 Controller.

Partial Pressure Setup

PPM100 can monitor and display partial pressures of up to eight independent single gases in a mixture. Each individual gas component is differentiated from all others based on its unique contribution to the mixture’s total mass spectrum- i.e. a single mass is selected to track each individual component’s partial pressure. For this reason, partial pressure measurements are also often called “single mass” measurements in this manual.

All partial pressure readings are performed within the RGA Head and transmitted back to the PPM100 for storage, display, process control and alarm activation. The PPM100 simply queries the RGA for the specified single mass measurements and displays the data on its front panel.

For detailed information on how gas specific partial pressure measurements are performed by the RGA Head, consult the SRS RGA Operating Manual at this time.

PPM100 has a menu-driven user interface. All operating parameters are grouped into menus. Consult Chapter 3 of this manual for detailed menu information.

Help

Help for any menu button is available on screen by touching the [Help] QuickKey and then the menu button.

PPM100 is preconfigured at the factory with partial pressure setup parameters for eight (8) very common residual gas components: hydrogen, helium, water, nitrogen, oxygen, argon, pump oil and carbon dioxide (PP1 through PP8, respectively). In order to enter new Partial Pressure setup parameters for component gases not included in the factory-default list, the user must follow the simple Partial Pressure setup procedure described below. This procedure must be repeated for every new partial pressure measurement programmed into the controller.

Step 1

Starting from the Pressure Display Screen, touch the [Monitor] QuickKey to access the Monitor Display.

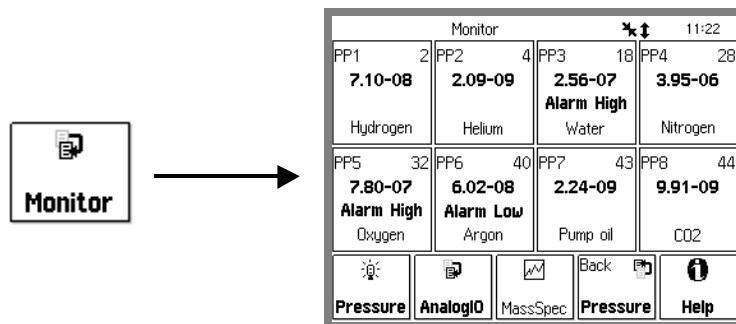

Figure 1-6. Monitor Display.

Step 2

Select the Partial Pressure Box (PP1-PP8) where you want the new single-mass partial pressure readings to be displayed by touching it. This brings up a Monitor/Setup menu for the selected box.

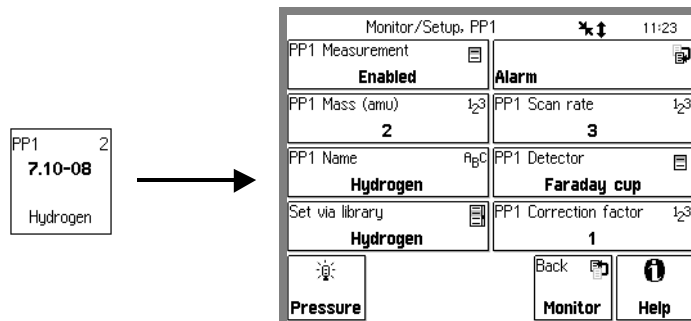



Figure 1-7. PP1 Partial Pressure Box and Monitor Setup menu

Step 3

Modify the Partial Pressure setup parameters, based on the measurement requirements specific to the single gas to be monitored (see Partial Pressure Parameters section below for details). Once finished, press the [Back] QuickKey to return to the Monitor Display Screen.

Step 4

Once finished modifying parameters, touch the [Pressure] QuickKey  to return to the original Pressure Display or simply remain in the Monitor Display Screen for simultaneous display of up to eight partial pressure measurements

Partial Pressure Parameters

A unique set of Partial Pressure parameters is required for each of the eight (8) single mass partial pressure measurements performed by the PPM100.

As an example, consider setting up the PP1 Partial Pressure measurement of the Monitor Display to track the partial pressure of methane (formula: CH₄, mass: 16 amu) in the gas mixture in contact with the RGA Head. For this common gas, the following parameters must be entered into the setup menu of the PP1 Partial Pressure measurement:

PP1 Measurement: Enabled

Each partial pressure measurement (PP1-PP8) can be individually enabled or disabled at any time, and according to changes in measurement requirements or gas composition.

PP1 Mass (amu): 16

The 16 amu mass value is commonly selected for monitoring methane, since it is the location of its main peak in the mixture's mass spectrum.

PP1 Name: Methane

A name entry is recommended to identify the PP1 Partial Pressure Measurement as the one tracking methane gas at the single mass: 16 amu.

PP1 Scan rate: 1 - 8

The Scan Rate determines the averaging performed by the RGA head during the PP1 partial pressure measurements. Averaging increases, and detection limit decreases, as the scan rate setting is reduced. The scan rate setting is interpreted as the Noise Floor setting (NF) for the single mass measurement by the SRS RGA Head. Consult the SRS RGA manual for details on this important measurement setting.

PP1 Detector: Faraday Cup or E. Multiplier

Select Faraday Cup or Electron Multiplier detector for all PP1 partial pressure measurements. Consult the SRS RGA Operating Manual for details on detector options.

PP1 Correction factor: 0.01 - 100

All partial pressure readings are calculated by the PPM100 from the ion current readings obtained from the RGA based on a sensitivity factor stored in the RGA Head and factory-calibrated against Nitrogen (@28 amu.) In order to correct the partial pressure readings for methane, and according to the specific ionization efficiency and mass specific throughput of its 16 amu mass peak, a correction factor needs to be calculated and applied. Note: This number usually requires special calibration.

Alarm: High and Low levels. Enable or Disable.

High and low alarm levels can be set for each individual partial pressure measured, to indicate system status directly in the Partial Pressure Boxes of the Monitor Display. *The alarm levels are independent from, and must not be confused with, the partial pressure levels used by the process control channel rules.*

Capacitance Manometer (CM1-4) Setup

Configure an Analog Port

All four Analog I/O ports are configured as inputs as a factory default.

To configure an analog port to read capacitance manometer pressures start by touching the [AnalogIO] Quickey in the Monitor Display Screen. This brings up the AnalogIO Display Screen with: (1) four data boxes for analog voltages (top row, AN1-AN4) and (2) four data boxes for CM readings (bottom row, CM1-CM4). Select the CM port corresponding to your capacitance manometer by simply touching its box- for example touch CM3 for a capacitance manometer connected to the AN3 port. This brings up the Monitor/AnalogIO/Setup menu for the selected CM box.

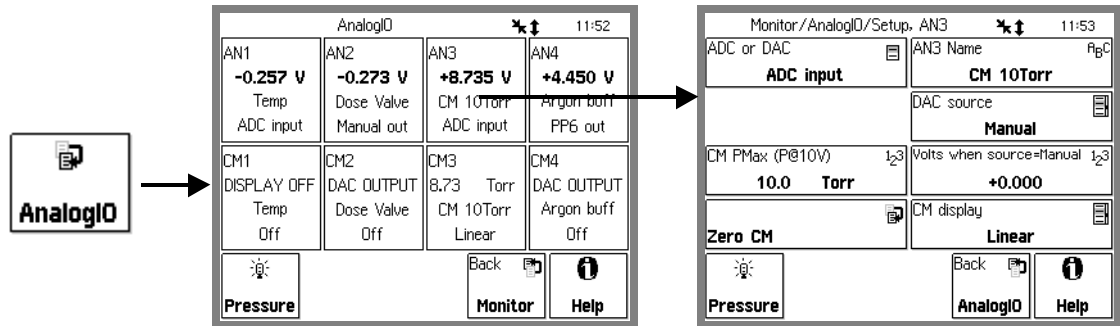

Figure 1-8. The [AnalogIO] QuickKey and AnalogIO Display screen

Several parameters must be adjusted in order to display capacitance manometer readings:

ADC or DAC

The I/O Mode should be set to ADC Input so that input voltages are read from the port.

CM Pmax (P@10V)

Pmax is the full scale range of the capacitance manometer (i.e. the pressure at which its output signal =10 Vdc). Its value is usually indicated on the outer casing of the gauge head. The full scale ranges most commonly encountered in commercial capacitance manometers are: 50 and 100 mTorr, and 1, 2, 10, 100 and 1000 Torr. Consult your gauge manufacturer(s) directly if unsure about your gauge's full-scale range.

CM Name

The CM Name entry is very convenient and its use is highly recommended in multi-gauge setups. PPM100 allows you to assign a unique name to each CM gauge. CM Names are displayed next to their pressure readings. Use the CM Name to differentiate between identical gauges in a multiple gauge setup.

CM display

The CM display must be set to Linear so that capacitance manometer pressures are calculated and displayed properly - i.e. following a linear relationship between output voltage and pressure and using the CM Pmax setting.

Once finished entering the new parameters, touch the [Back] QuickKey  to return to the AnalogIO Display Screen, CM gauge voltages and pressures are now displayed in their corresponding data boxes.

Pressure Measurement

This section describes the steps required to measure and display partial and total pressures from an SRS RGA and (up to four) capacitance manometer gauges connected to the PPM100. This is the final step of the installation procedure.

It is assumed that one SRS RGA and (at least) one capacitance manometer (CM1 connected to AN1) - are connected to the back ports, and that the controller has been completely configured, using the instructions of the previous section. For simplicity, the front panel is assumed to be in Monitor Display with factory default gas settings. Only manual operation of the gauges is discussed.

Pressure readings may be displayed in various formats, in several different units and are continuously updated. When logging is enabled, data from the SRS RGA, CM gauges and analog inputs are stored in an internal data log at a user-programmable rate. The data log can be displayed in either table or chart (P vs. time) formats.

Warm-up times

To minimize temperature-induced drift in partial pressure readings, warm-up times must include operation of the SRS RGA at the selected emission current for at least thirty minutes. PPM100 warm-up times of at least twenty (20) minutes are recommended for stable analog voltage readings.

Partial Pressure Measurements (PP1-PP8)

WARNING!

- Do not operate the SRS RGA in the presence of explosive, flammable or combustible gases.
- Do not operate the SRS RGA at pressures $>10^{-4}$ Torr since that will significantly affect the filament's lifetime and will deliver useless results.

In order to perform partial pressure measurements with a residual gas analyzer, its filament must first be turned on. For manual operation, press the FILAMENT power button located on the PPM100 front panel. The green FILAMENT LED to the right of the FILAMENT button lights up to indicate the presence of electron emission. *The filament current ramps up over a few seconds* minimizing pressure bursts in the vacuum system and emission current overshoot in the RGA head.

As soon as full emission current is established, partial pressures from the RGA Head start to be displayed on all "enabled" PP1-PP8 Partial Pressure Boxes of the Monitor and Pressure Display Screens, and all related process control and alarm activation is enabled.

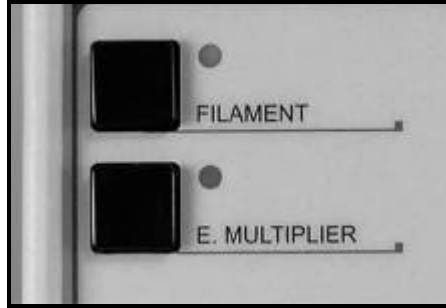

Figure 1-9. Front panel controls - FILAMENT power button/LED and E. MULTIPLIER power button/LED.

A “WAIT” message is displayed in the Partial Pressure Data Box while electron emission current is being established, and all pressure readings are ignored until full (and stable) emission current is detected in the SRS RGA Head. No process control or alarm actions are performed based on ionization gauge readings during the time the emission current is being set.

Partial Pressure readings in the PP1-PP8 data boxes are continuously updated in a sequential and circular fashion and at an update rate determined by the collective Scan Rate settings of all the single mass measurements enabled.

Monitor				*↑		11:54	
PP1 2	PP2 4	PP3 18	PP4 28				
6.09-08	4.95-09	1.03-07	3.86-06				
Hydrogen	Helium	Alarm High Water	Nitrogen				
PP5 32	PP6 40	PP7 43	PP8 44				
7.70-07	5.86-08	2.90-09	7.02-09				
Alarm High Oxygen	Alarm Low Argon	Pump oil	CO2				
Pressure	AnalogIO	MassSpec	Back	Pressure	Help		

Figure 1-10. Monitor Display Screen for the PPM100 with the eight Partial Pressure Boxes enabled.

Press the FILAMENT power button again to turn the emission off – "FILAMENT OFF" is displayed in all partial Pressure boxes.

As a general rule, if the RGA electron emission is on, the PPM100 is either collecting (single mass) partial pressure measurements or performing analog scans. The only way to interrupt data collection from the RGA Head is by turning off the filament emission.

Capacitance Manometer Readings (CM1-CM4)

The most direct way to display simultaneous total pressure readings from (up to four) capacitance manometers is to access the AnalogIO Display Screen of the PPM100 through the Monitor Display Screen.

From the Monitor Display, touch the AnalogIO Button  to access the AnalogIO Display screen. The total pressure readings for up to four capacitance manometers (CM1-4) are displayed in the bottom four CM Data Boxes (CM1-4 respectively). For convenience, the corresponding voltage outputs of the gauge heads are simultaneously displayed in the top four AnalogIO Data Boxes.

The analog I/O ports are continuously monitored, and its readings stored in memory, independently from the SRS RGA readings.

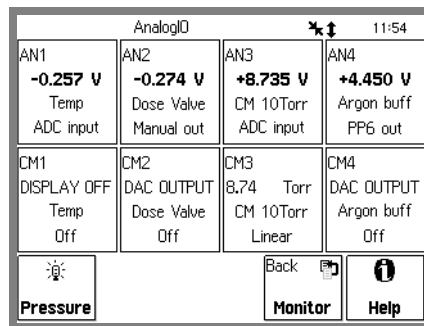



AnalogIO				11:54
AN1 -0.257 V Temp ADC input	AN2 -0.274 V Dose Valve Manual out	AN3 +8.735 V CM 10Torr ADC input	AN4 +4.450 V Argon buff PP6 out	
CM1 DISPLAY OFF Temp Off	CM2 DAC OUTPUT Dose Valve Off	CM3 8.74 Torr CM 10Torr Linear	CM4 DAC OUTPUT Argon buff Off	
 Pressure		Back 	 Help	

Figure 1-11. AnalogIO Display Screen

Pressure Display Screen

The Pressure Display Screen provides an additional, convenient and flexible way to display up to three pressures and voltage signals. It is also the only display mode that provides access to the Logging (i.e. Table/Chart) and Process Control modes of the PPM100 controller.

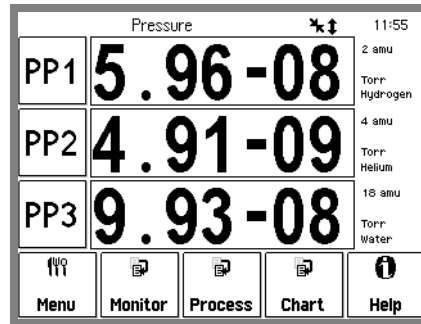



Figure 1-12. Pressure Display Screen with three data bars.

Use the [Pressure] QuickKey  to bring up the PPM100 Pressure Display at any time.

The Pressure Display Screen consists of three Data Bars, each displaying a pressure (total or partial) or analog signal. Readings may be displayed in various formats and are updated twice a second.

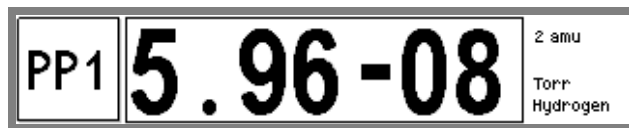

Figure 1-13. Data Bar consisting of three adjacent boxes: ID (left), Data (center) and Info (right).

Each Data Bar consists of three adjacent boxes: ID (left), Data (center) and Info (right). Customize a Data Bar by touching the ID or the Data boxes.

The ID box shows the source of the readings displayed by the data bar: PP1-PP8, CM1-CM4 or AN1-AN4. For example, the PP1 Data Bar above displays partial pressure readings from the RGA, in Torr, corresponding to the single-mass peak at 2 amu and assumed to be originating from the single gas hydrogen.

Touch the ID box to select a different data source (i.e. another partial pressure measurement, a CM pressure or an analog signal) for that Data Bar. To display capacitance manometer readings, identify the Analog I/O port (1-4) connection and choose the appropriate CM port (CM1-4) (For example, choose CM1 for a capacitance manometer connected to the Analog I/O 1 port.)

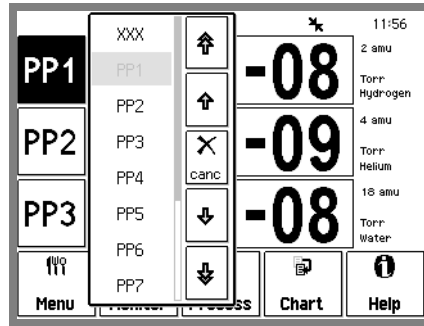

Figure 1-14. Select a source for the top data bar.

Note

The analog and pressure output display will show 'OVERLOAD' if the Pressure Output signal exceeds 12 V.

Data Display Options

The Data area of the Data Bar is where the readings are displayed. Touch inside the Data box to choose a display format. Eight options are available.

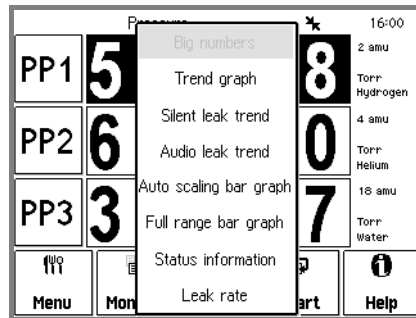

Figure 1-15. Select a display option for the middle data bar.

Big Numbers

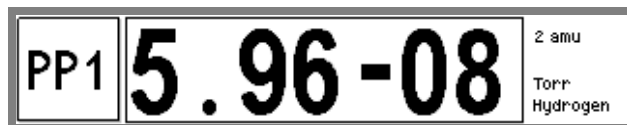

Figure 1-16. Big Numbers data display.

Best display for accurate, easy to view, pressure readings. Easily visible across the room.

Trend Graph



Figure 1-17. Trend Graph display.

Best display for trend analysis. A stamp-sized 'Signal vs. time' plot of the 10 most recent readings, sampled at the data logging interval (see 'Logging' below). It also includes a small instantaneous reading next to the plot. Use trend graphs to see pressure changes in time-dependent processes such as leak testing, pump downs, venting, bakeout, etc.

Silent/Audio Leak Trend Graph

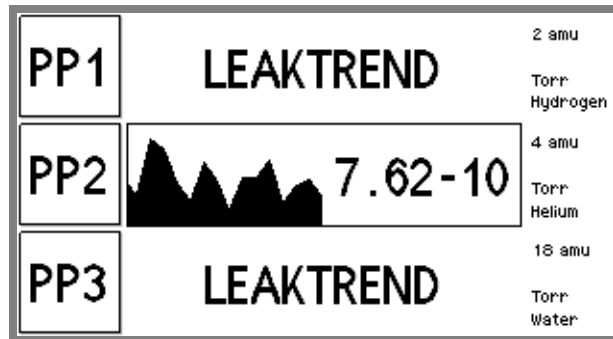

Figure 1-18. Leak Trend Graph display.

Best display for leak detection applications (see "Leak Testing with the PPM100" below). Use this display while leak testing components attached to the vacuum system. Use leak trend graphs to detect leaks as partial pressure transients while spraying the vacuum system components with a tracer gas such as helium or argon.

A stamp-sized 'Signal vs. time' plot of the 10 most recent partial pressures for the selected mass is displayed. A small instantaneous partial pressure reading is also included next to the plot.

When 'Audio Leak Trend' is selected, a repetitive audio signal whose frequency is proportional to the partial pressure readings provides a means to "hear" pressure transients, eliminating the need to look at the front panel display while searching for leaks.

In order to provide optimum data acquisition rates at the mass of interest, all other partial pressure readings and displays are disabled while in this display mode. The other Data Bars will show "LEAKTREND" until a non-LeakTrend display is chosen for this Data Bar.

Warning!

All process control channels must be in manual mode to be able to access the Silent/Audio Leak Trend Display mode.

Auto Scaling Bar Graph



Figure 1-19. Auto Scaling Bar graph.

Best display to detect instantaneous changes in pressure readings. Three decade logarithmic bargraph display scaled about the current reading. Often used during leak testing procedures. This display preserves the 'feel' of the old analog needle displays preferred by some vacuum users.

Full Range Bar Graph

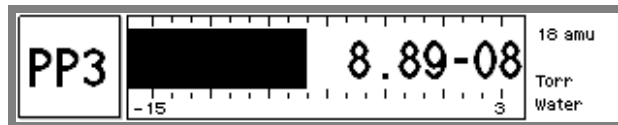

Figure 1-20. Full Range Bar Graph display.

Best display to view the overall status of your vacuum system at any given time. Fifteen decade logarithmic bargraph display, covering the entire useful range of the instrument (10^{-15} to 10^3 Torr). The scale covers the entire range from UHV to atmosphere.

Leak Rate

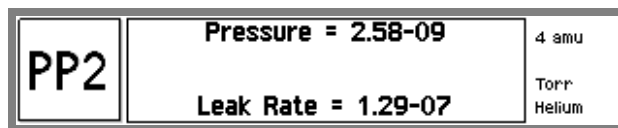

Figure 1-21. Full Range Bar Graph display.

Use this display to calculate and view leak rates from the measured partial pressure. Use this display to measure leak rates for components attached to the vacuum system.

$$\text{Leak Rate} = \text{Partial Pressure} \times \text{Leak Rate Coefficient}$$

where the Leak Rate Coefficient is a user specified parameter stored in the PPM100.

Status Information

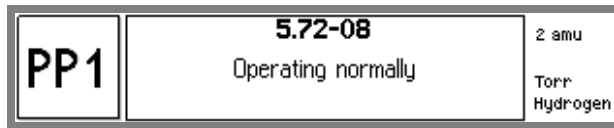

Figure 1-22. Status Information display.

Use this display to learn more about the state of the RGA Head, a gauge or an analog port. This is especially useful if the gauge is in a fault or error condition.

The lowest line in this display shows who last modified the status of the gauge (front panel user, remote user, etc.).

Pressure Units

The factory default for pressure units is Torr (1 Torr = 1 mm Hg).



Use the [Menu] QuickKey to display the Main menu. Touch [Units] to choose a different units system: Torr, micron, bar, mbar, or Pascal.

Logging

When Logging is enabled (factory default), data from all partial and total pressures and analog signals are stored in a circular data buffer at a rate specified by a user adjustable Logging Interval. The logged data for the three sources selected in the Pressure Display screen can be viewed at any time in the Data Log Display in either table or chart format. This allows users to switch readily between instantaneous and logged readings for the measurements of interest.

In order to access the Data Log display, follow these simple steps:

Step 1

Bring up the Pressure Display by touching the [Pressure] QuickKey .

Step 2

Touch the [Chart] or [Table] QuickKey to display the log in Chart/Table format.

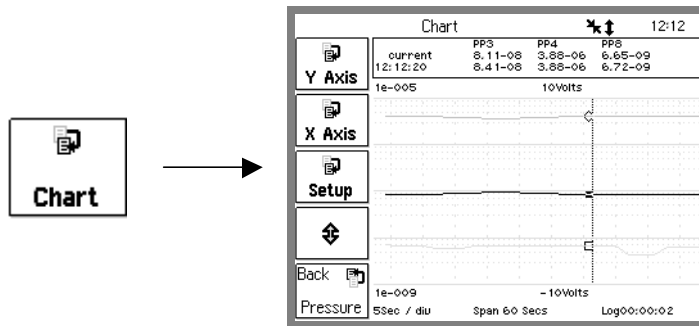

Figure 1-23. Press [Chart] to display the chart of the data log.

Step 3

Touch the [Setup] button to access the Logging Setup menu.

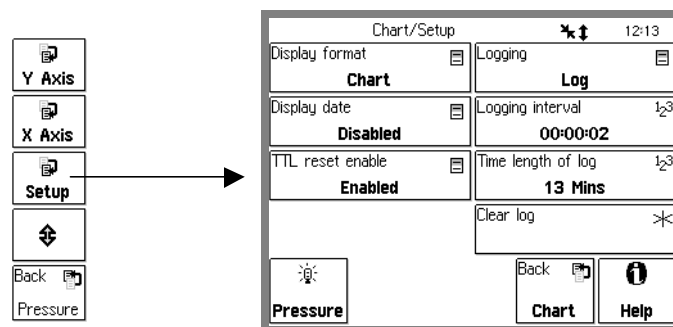



Figure 1-24. Logging Setup menu. Choose between Chart and Table display formats or adjust Logging Parameters.

Step 4

Select Table or Chart display format. Activate Logging or change the Logging Interval as required using the menu.

MassSpec Display

The MassSpec Display Screen provides a direct and flexible way to display mass spectra collected by the RGA head directly on the front panel of the PPM100.

From the Monitor Display screen, press the [MassSpec] QuickKey  to access the Monitor/MassSpec Display. If not already on, press the FILAMENT button to establish electron emission and activate the display of mass spectra on the front panel.

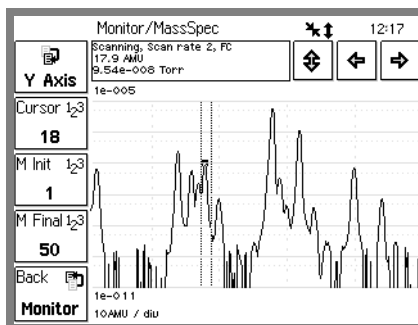

Figure 1-25. Analog MassSpec screen with factory-default 1 thru 50 amu mass range.

Analog scanning is the most basic operation of the SRS RGA as a quadrupole mass spectrometer. During analog scanning the quadrupole mass spectrometer is stepped at fixed mass increments (i.e. 0.1 amu) through a prespecified mass range. The ion current is measured after each mass-increment step and transmitted to the PPM100 over RS-232. Analog scanning simplifies the detection of mass peaks for individual component gases, and provides the most direct view of the peak shapes and resolution of the instrument.

Warning!

All single mass Partial Pressure readings are suspended while the PPM100 displays MassSpec analog scans. As a consequence, **all process control channels must be set to 'Manual' mode** before this display mode may be accessed. Partial pressure readings resume as soon as the MassSpec display is exited.

Tip

Use the Analog MassSpec Display mode to identify and select single masses during the Partial Pressure Measurement setup.

Press the E. MULTIPLIER button at any time to activate the electron multiplier detector during analog scans, and enhance the detection limit of the SRS RGA. Press the E. MULTIPLIER button again to turn the electron multiplier off and return to Faraday Cup detection.

Notes

- The E. MULTIPLIER button has **NO** function outside of the MassSpec mode.
- The electron multiplier can only be turned on if the filament is already on and emitting electrons.

- The electron multiplier is automatically shut down if the filament is turned off in the middle of an analog scan. This is to protect the electron multiplier from overpressure.
- The electron multiplier is shut down when the MassSpec Display is exited.

Using the Display

Touch the [M Init] and [M Final] buttons to adjust the mass range of the spectrum. Use the cursor button to move the vertical cursor and obtain partial pressure information at a specific mass. Use the left and right arrows to step the cursor in 1 amu increments over the mass spectrum while displaying the mass and partial pressures of the mass peaks detected after each step. Use the up and down arrow button to autoscale the vertical axis.

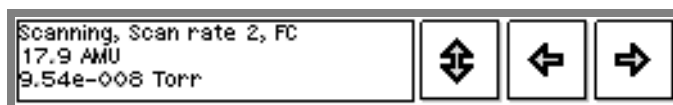

Figure 1-26. Cursor display of Analog MassSpec.

The scan rate and RGA ionization parameters are adjusted through the RGA Setup menu, which is accessed through the Main Menu. Starting from the Pressure Display, press the [Menu] QuickKey. Once in the Main Menu, touch the [RGA] button to access the RGA Setup menu. Use this menu to : (1) adjust ionizer parameters (i.e. electron energy, ion energy, filament emission and focus voltage), (2) change the noise floor (i.e. scan rate) for analog scans, and (3) calibrate the detector. Consult Chapter 3 for details on these menu items.

Leak Testing with the PPM100

An RGA can be used as a leak detector to detect helium as well as many other gases. The preferred method for using an RGA in this application is to mount it directly on the vacuum chamber and spray helium on the suspect flanges, welds and bellows. If there is a leak, the helium will enter the system and the RGA will detect its presence inside the vacuum environment. The PPM100 includes two leak trend displays (silent and audio) with audible alarms and real-time displays of tracer gas pressure versus time to simplify leak testing. Since the mass spectrometer is not restricted to helium detection, other tracer gases can be used as alternatives to helium - neon, oxygen, argon, fluoroform and krypton are the five most common helium substitutes used in conjunction with RGAs.

The most distinguishing advantage of an in-situ RGA over a conventional helium leak detector is its ability to detect leaks in real time, and without the need for any specific tracer gas. The most common problem in vacuum systems is air leaks. A PPM100 connected to an RGA can be set to continuously monitor the mass spectrum of a vacuum chamber looking specifically for the distinctive 4:1 ratio of nitrogen (mass 28) and oxygen (mass 32) corresponding to an air leak. An in-situ RGA provides the only way to detect leaks that only manifest themselves during dynamic processes such as the actuation of defective sample manipulators, gates or valves.

Because of its ability not only to detect and alert of a leak problem but also to help with its correction, the RGA is the tool of choice in many high throughput vacuum-manufacturing facilities.

The RGA is invaluable for the detection of virtual leaks. Small trapped volumes of gases such as air, water and machining oils within the inner surfaces of a vacuum system are virtually impossible to detect without using an RGA to detect AND identify the gases being released into the vacuum.

RGAs have been used for many years as the preferred sensors for ultrahigh sensitivity helium leak detectors with leak-rate capabilities extending into the 10^{-18} std cc/sec (as required for extreme vacuum applications.) These leak detectors rely on an adsorption/desorption method to first preconcentrate the leaking gas on a cold surface and then release the gas quickly by allowing the surface temperature to rise.

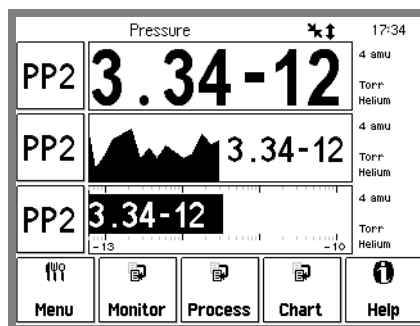

Figure 1-27. A common Pressure Display while leak testing. The top data bar provides a leak trend graph, the middle bar displays the actual leak rate and the bottom bar provides a bargraph to visualize leaks.

Proper Grounding Test Procedure

Read the entire **Safety and Preparation for Use** section of this manual before starting any installation procedure.

WARNING!

- Safe operation of any high-voltage, ion-producing vacuum equipment, including the SRS RGA/PPM100, requires proper grounding of all electronics control units and vacuum chamber. **LETHAL VOLTAGES** may be established under certain operating conditions if proper grounding is not assured.
- **This risk is not specific to the PPM100!**

As a rule-of-thumb, *all parts of a vacuum system* utilized with the SRS RGA/PPM100, or any similar high voltage product, *must be maintained at earth-ground for safe operation.*

- **The vacuum chamber should be directly, and explicitly, connected to a heavy-duty earth-ground** (minimum 12 AWG ground lead wire).
- All electronic instrumentation must be connected to properly grounded 3-prong electrical outlets. **A chassis grounding lug must also be directly tied to an earth-ground electrode** (minimum 12 AWG wire). *Do not connect the controller's ground lug to the vacuum system or another component.* Connecting the power cord to a properly grounded outlet is a necessary, but not sufficient grounding condition with this (or any similar) high voltage producing vacuum equipment.
- **All conductors** in, on, or around the vacuum system that are exposed to potential high voltage electrical discharges **must either be shielded** at all times to protect personnel **or be permanently connected to the facility's earth-ground.** Consult an experienced electrician if necessary!!!
- High-voltage ion-producing equipment such as a hot-cathode ionization gauge or residual gas analyzer can, under certain circumstances, provide sufficient electrical conduction via a plasma to couple a high-voltage potential to the vacuum chamber walls. *Any exposed conductive parts of a gauge or vacuum chamber may attain high voltage potentials through this process if not properly grounded.* Grounding the PPM100 does not and cannot guarantee that other components of the vacuum system are all maintained at earth ground.

Perform regular electrical ground-tests on your entire vacuum system, particularly if it is shared by multiple users who often perform custom modifications on the chamber's configuration.

Ground Test Procedure:

Step 1

Carefully examine your vacuum system:

- ❑ Are all exposed connectors and conductors on the vacuum chamber grounded?
- ❑ Are all ground connections properly connected to a solid earth or facility ground?
- ❑ Beware! Some vacuum systems rely on water piping for the earth-ground connection. Proper ground connection can be easily lost by inadvertently inserting a plastic interconnect into the water line.
- ❑ Keep in mind that the use of O-ring seals without metal clamps or bolt connection can isolate big portions of a vacuum system from its safety ground. Add metal clamps if necessary.
- ❑ Verify that the vacuum port to which any new component is about to be mounted is electrically grounded. Use a ground lug on a flange bolt if necessary.

Step 2

With the SRS RGA and PPM100 controllers turned off (but still plugged into an outlet):

- ❑ Test for both AC and DC voltages between the metal parts of the vacuum system and the controller's chassis. No voltage differences should be detected.
- ❑ If no voltages are detected, measure resistance between all parts of the vacuum system, and between the vacuum system and the controller: <2 Ohms assures a commonality of grounds between the different parts of the vacuum setup and prevents the development of high voltages between different sections of the vacuum setup in the presence of a high voltage plasma discharge.
- ❑ If AC or DC voltages exist or more than 2 ohms is detected, professional help is recommended.

Chapter 2

PPM100 Basics

This chapter describes the basic features and functionality of the PPM100 controller.

In This Chapter

PPM100 Overview	2-3	Front Panel	2-13
Residual Gas Analysis (RGA100/200/300)	2-3	Power	2-13
Analog I/O Ports (AN1-4)	2-4	LINE LED	2-13
Input	2-5	POWER Button and LED	2-13
Output	2-5	Reset	2-14
Capacitance Manometers (CM1-4)	2-5	RGA Controls	2-14
Data Logging (Charts and Tables)	2-6	FILAMENT Button and LED	2-14
Pressure Data Displays	2-7	E. MULTIPLIER Button and LED	2-14
Monitor Display	2-7	Touchscreen/LCD Display	2-14
Pressure Display	2-7	Touchscreen Cleaning Procedure	2-15
Pressure Units	2-8	Process Control LEDs	2-15
On-Screen Help	2-9	Back Panel	2-16
Backlight Saver	2-9	±15 V AUX Power Connector	2-16
RS-232 Computer Interface	2-9	Process Control	2-17
GPIB Interface	2-10	Relay Contacts	2-17
USB Interface	2-10	DIGITAL TTL I/O	2-18
Embedded Web Server (Opt. 01)	2-10	RGA RS-232 Connector	2-20
Process Control	2-11	HOST RS-232 Connector	2-20
		Analog I/O	2-21
		BNC Ports (AN1-4)	2-21
		Maintenance and Service	2-22

PPM100 Overview

WARNING!

- Read the entire **Safety and Preparation for Use** section of this manual before using the PPM100.
- Read Chapter 1 for detailed instructions and safety information regarding the installation and connection of the SRS RGA and capacitance manometer gauges.

The PPM100 Partial Pressure Monitor is a fully programmable, microprocessor-based vacuum system controller.

The PPM100 is a high accuracy controller that measures: (1) partial pressures from an SRS RGA100/200/300 residual gas analyzer and (2) total pressures from up to four capacitance manometers, providing uninterrupted pressure readings from 1000 Torr to UHV. The PPM100 has a touchscreen LCD display, pressure vs. time plots, built-in relays for vacuum system control and several multipurpose (analog and digital) I/O ports. RS-232, USB, GPIB and Web (ethernet) interfaces are standard in all controllers.

Four Analog I/O ports, configurable as inputs or outputs, can be independently programmed to provide: (1) capacitance manometer readings, (2) analog input signal readings, (3) output voltages linked to partial pressure values, and (4) manual or software-controlled output voltages.

Controller operation is simple and intuitive via a menu-driven touchscreen user interface. The screen displays readings in a large, easy-to-read numeric format, as well as in bar graph and trend formats. Readings are updated twice a second and pressures can be displayed in several units systems. Data Logging and Pressure vs. Time plots allow you to follow pump down and venting cycles and keep track of process relay activity, analog input signals and gauge operations, to within a fraction of a second.

Complete controller specifications are included in the introductory pages of this manual.

This section details the main features of the PPM100.

Residual Gas Analysis (RGA100/200/300)

The PPM100 Partial Pressure Monitor is designed to monitor and control a single SRS RGA100/200/300 residual gas analyzer within the 10^{-14} to 10^{-4} Torr pressure range supported by the quadrupole-based mass spectrometer. A menu-driven user-interface allows the PPM100 operator to easily program all required RGA Setup parameters from the controller's front panel- i.e. no PC setup is required. Pressure readings are updated at rates up to 2 Hz.

Warning!

PPM100 is not compatible with third-party residual gas analyzers.

All communications between the PPM100 and the SRS RGA Head take place over a standard RS-232 serial interface connection. *No power* is delivered to the RGA Head from the PPM100 controller.

Up to eight independent partial pressures, can be monitored and simultaneously displayed on the front panel. Each partial pressure reading can have its own (i.e. individualized) (1) mass, (2) detector, (3) scan rate and (4) alarm settings. This mode of operation is used to generate single gas data for leak testing measurements, and to track changes in the concentrations of up to eight independent components of a gas mixture as a function of time. The partial pressure signals can also be linked to alarms, process control relays and digital output ports.

A MassSpec Display mode is also available to graph RGA Mass Spectra directly on the front panel of the instrument. Analog scanning is the most basic mode of operation of the SRS RGA as a quadrupole mass spectrometer. During analog scanning the quadrupole mass spectrometer is stepped at fixed mass increments (i.e. 0.1 amu) through a prespecified mass range. The ion current is measured after each mass-increment step and transmitted to the PPM100 over RS-232. Analog scanning simplifies the detection of mass peaks for individual component gases, and provides the most direct view of the peak shapes and resolution of the mass spectrometer.

Tip

Use the Analog MassSpec Display mode to identify and select single masses during the Partial Pressure Measurement setup.

Partial pressure measurement with a residual gas analyzer requires that the filament be turned on. The PPM100 includes a FILAMENT button on its front panel for manual activation of partial pressure measurements. Press the E. MULTIPLIER button to activate the electron multiplier detector during analog scans. Filament emission and electron multiplier can also be activated remotely through (1) software control, (2) Remote TTL control, and (3) web-interface (requires Web Interface, Opt. 01). Degassing of the SRS RGA ionizer can be activated from the PPM100 front panel. Consult Chapter 3 for details on menu options.

For More Information

Chapter 1 includes all the installation and setup information required to set up your PPM100 controller and its gauges. Chapter 3 describes, in detail, the menu-based user interface, including all menus required to configure the PPM100 for operation with an SRS RGA100/200/300 and (up to four) capacitance manometers.

Analog I/O Ports (AN1-4)

All PPM100 controllers have four analog input/output ports (BNC connectors) on the back panel. Their range is ± 12 V with 14-bit input resolution and 12-bit output resolution. The update rate is 2 Hz. Each port is individually configured as an input or an output for complete I/O flexibility.

Input

Input signals (dc voltages) may be displayed on the Pressure or AnalogIO Display Screens, and monitored remotely through the computer and web interfaces. When Data Logging is enabled, all analog input voltages are stored in memory as part of the logging data set.

Use ANALOG I/O ports as inputs to read voltages from additional vacuum equipment such as capacitance manometers, third-party gauges with analog outputs, mass flow controllers, turbo pump controllers, etc.

Capacitance manometers must be connected to ANALOG I/O ports configured as inputs, and CM Display must be set to linear. Direct pressure readings are available only if their full scale pressure (Pmax) is programmed into the controller (i.e. pressure corresponding to 10 V output).

Direct pressure display from compact gauges are also possible if (1) Pmax is properly programmed (i.e. pressure corresponding to 10 V output), (2) CM Display is set to Log and (3) if the voltage output of the compact gauge is related to the log of the pressure- with a 1V/decade scaling factor.

Output

Analog output levels can be adjusted manually from the front panel, remotely through the computer interface, or they can be linked to the log of partial pressures PP1-PP8.

Use analog I/O ports as outputs to control auxiliary vacuum equipment such as heaters, actuators, ion sources, programmable logic controllers and throttle controllers.

For More Information

Consult Chapter 4 of this manual for a complete description of the ANALOG I/O capabilities of the PPM100, including specifications, connections, possible configurations, and capacitance manometer operation. Chapter 3 describes, in detail, the menu-based user interface, including all menus required to configure the PPM100 for proper operation of its ANALOG I/O ports.

Capacitance Manometers (CM1-4)

The standard PPM100 controller can display pressure as measured from standard capacitance manometers (CMs). Up to four independent CM readings can be monitored simultaneously using the four ANALOG I/O ports located on the back of the controller. Pressure readings are updated at 2 Hz. The PPM100 precisely measures the 0 to 10 Vdc linear output signal from the CM to determine pressure. Direct pressure readings are available only if the full scale pressure (Pmax) of the gauge is entered into the controller, and CM Display is set to Linear. Full-scale ranges up to 1000 Torr are supported by the controller.

For added convenience, the PPM100 also supplies an auxiliary (AUX) ± 15 V, 100 mA power output. This is usually sufficient to power up a pair of standard (i.e. non-heated) capacitance manometers.

For critical applications where repeatability, precision, and composition independent readings are required, a capacitance manometer gauge should be used to monitor and control the process pressure! This is particularly true if complex or changing gas mixtures are involved.

For More Information

Chapter 1 includes all the basic information required to install and set up your PPM100 controller and its gauges, including capacitance manometers. Consult Chapter 4 of this manual for further details on the operation of capacitance manometers and their proper connection to ANALOG I/O ports. Chapter 3 describes, in detail, the menu-based user interface, including all menus required to configure the PPM100 to display pressure readings from capacitance manometer gauges.

Data Logging (Charts and Tables)

All PPM100 controllers include Data Logging capabilities. When Data Logging is enabled, data from *all* monitored partial pressures and *all* analog inputs are stored in a circular memory buffer at the rate specified by a user-programmable logging interval.

The logged data can be accessed through the touchscreen LCD - the logged data for the three Data Bars in the Pressure Display screen are presented in a single window. Both table and chart (P vs. Time) displays are available. The chart display includes convenient graphical tools such as (1) cursor, (2) zoom, (3) x,y scaling (manual and auto), and (4) cursor readings. Users can switch rapidly between current and logged readings for the pressures or analog signals of interest.

The data log can also be accessed remotely through the computer interface, or through the Internet when using the embedded web server.

The data log can be cleared manually, at any time, from the front panel (use Clear Log), remotely via the Remote TTL Control Module or via the computer interface.

Typical applications of the Data Logging capabilities include capturing pump-down or venting curves for vacuum system characterization, monitoring mass flow controller signals during deposition processes, and monitoring temperatures and other time dependent variables during bakeouts or heat treatments.

For More Information

Consult Chapter 3 of this manual for detailed information on the Data Logging capabilities of the PPM100 and Chapter 5 for information on the Remote TTL Control Module.

Pressure Data Displays

Monitor Display

The Monitor Display Screen provides simultaneous display of up to eight partial pressure measurements in eight data boxes labeled: PP1 through PP8.

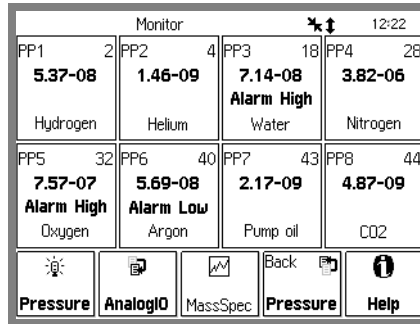

Figure 2-1. The Monitor Display screen with factory default Partial Pressure settings.

Each Partial Pressure Box displays a partial pressure reading along with the mass, gas name and alarm status for its single mass measurement. Press a data box to access its Partial Pressure setup menu and modify its single mass measurement parameters.

The Monitor display also provides the only access to: (1) the AnalogIO display screen ([AnalogIO] QuickKey) used to display analog I/O voltages and CM readings, and (2) the MassSpec screen ([MassSpec] QuickKey) used to display analog mass spectra.

Pressure Display

The Pressure Display Screen provides an additional, convenient and flexible way to display up to three pressures and voltage signals. It is also the only display mode that provides access to the Charting (i.e. logging) and Process Control modes of the PPM100 controller.

The Pressure Display Screen can present pressures and analog signals in a variety of numeric and graphical formats:

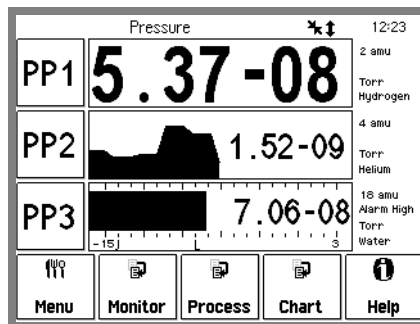

Figure 2-2. Pressure display using 3 different data display formats.

Big Numbers

Best for pressure readings. Easily visible across the room.

Trend Graph

A stamp-sized 'P vs. Time' plot of the most recent points. It also includes a small, instantaneous pressure display next to the plot. Best for trend analysis.

Silent/Audio Leak Trend

A stamp-sized "P vs Time" plot of the most recent points. It also includes a small, instantaneous pressure display next to the plot. When 'Audio Leak Trend' is selected, an audio signal whose frequency is proportional to the pressure provides a means to "hear" pressure transients, eliminating the need to look at the front panel while detecting leaks.

To provide optimum data acquisition rates at the selected mass, all other partial pressure reading boxes are disabled by this display mode.

Auto Scaling Bar Graph

Three decade logarithmic bargraph display scaled about the current readings.

Full Range Bar Graph

Fifteen decade logarithmic bargraph display, covering the entire useful range of the instrument (10^{-15} to 10^3 Torr). The scale covers the entire range from UHV to atmosphere.

Leak Rate

Calculate and display the Leak Rate based on the partial pressure. Use this for leak testing.

Status Information

Display additional information about the gauge status. Use this to troubleshoot fault conditions.

The Pressure Display is also the only screen that provides access to the process control and chart/logging modes of the PPM100.

For More Information

Consult Chapter 3 for a complete listing of menu items related to data display formats. Chapter 1 discusses examples of common applications of the different display formats in its Pressure Measurement section.

Pressure Units

The factory default for pressure units is Torr (1 Torr = 1 mm Hg). Users may choose a different units system (micron, mbar, bar, and Pascal) in the Main Menu.

For More Information

Consult Chapter 3 for a guide to the menus required to change pressure units.

On-Screen Help

On-screen help is available in all PPM100 controllers. Extensive Help information is readily available for menus, buttons, displays and even hardware. From any screen where it is displayed, touch the [Help] button and then any button for which help is required.

For More Information

Touch [Help], then [Help] again, for a complete description of the PPM100 help system.

Backlight Saver

The PPM100 touchscreen LCD is illuminated by a fluorescent lightbulb (physically located to the side of the screen). Use the Backlight Saver to extend the life of the bulb. All PPM100 features remain functional while the backlight is off.

When the Backlight saver is enabled, the light turns off when the touchscreen is inactive for period longer than a user-specified period. Turn-off and turn-on times can also be programmed into the controller to keep the backlight off overnight.

For More Information

Consult Chapter 3 for menu options related to the Backlight saver capabilities.

RS-232 Computer Interface

The PPM100 controller comes standard with an RS-232 communications port (HOST RS-232 connector on the back panel). A host computer connected to the instrument can easily configure, diagnose and operate the PPM100 controller using simple ASCII commands. An intuitive and complete Remote Command Set facilitates integration of all controller functions into any processing or diagnostic software.

As an added feature, the RS-232 interface includes a pass-through mode which passes RGA commands through the PPM100 directly into the SRS RGA head and transmits the RGA responses back out using communication parameters *identical* to the RGA head.

Tip

Use the RS-232 pass-through mode to communicate directly with the RGA head through the PPM100 with a host computer running RGA Windows. Since the PPM100 RS-232 port will be configured identically to the one in the RGA head, RGA Windows operates as if the host computer were connected directly to the RGA head.

The RS-232 interface is easily configured through the front panel user interface. A variety of baud rates, byte framing and handshaking options are available. The PPM100 buffers the most recent characters received and transmitted over the communication interface (RS-232, GPIB, USB and Web). The Queue can be displayed on the front panel at any time (Queue display mode) simplifying testing and debugging of communication programs.

Note that the PPM100 is a stand-alone instrument - there is no need to connect the controller to an external computer to access its full performance and functionality. All

instrument functions and parameters are manually accessible and easily modified through the front panel.

Computer interfacing is only required for: (1) Computer monitor/control of the PPM100 and vacuum system, (2) Remote access to data-logs and history lists, (3) calibration data uploads, and (4) firmware upgrades (for controller and web-server).

For More Information

Consult Chapter 6 of this manual for more detailed information on the available computer interfaces (RS-232, USB and GPIB), programming options and complete command set. Consult Chapter 3 for information on menu items related to configuration of the RS-232 interface. A complete Command Set is also listed at the beginning of this manual.

GPIB Interface

A GPIB (IEEE-488) interface is standard in the PPM100. The GPIB interface uses the industry standard 24-pin connector.

The same command set is shared between the RS-232, USB and GPIB interfaces.

For More Information

Consult Chapter 6 of this manual for detailed information on computer interfaces (RS-232, USB and GPIB), programming options, command set, and firmware upgrade procedures (controller and web-server). Consult Chapter 3 for information on front panel configuration of the GPIB interface.

USB Interface

A USB (Universal Serial Bus) interface is standard in the PPM100. The USB port, located on the back plane of the PPM100, uses the industry standard 4-pin connector.

For More Information

Consult Chapter 6 of this manual for detailed information on computer interfaces (RS-232, USB and GPIB), programming options, command set, and firmware upgrade procedures (controller and web-server). Consult Chapter 3 for information on front panel configuration of the USB interface.

Embedded Web Server

The Embedded Web Server (EWS) connects the PPM100 to the Internet.

The EWS is a TCP/IP compatible web server that resides inside the PPM100 box, continuously gathering data from the instrument. When connected to an ethernet network with an internet gateway, the EWS can deliver PPM100 data to a user anywhere on the world wide web using a standard browser. Users can monitor your vacuum system from anywhere in the world. E-mail notification can notify a client list of potential or actual system problems.

The EWS provides the most

convenient way to access PPM100 data from a computer without writing custom serial or GPIB based software. The EWS can be configured to allow access to process control functions, so that a user can control their vacuum process from anywhere in the world.

Use the web-interface to monitor your vacuum system from your office or from home without having to pay periodic visits to your lab while waiting for your system to pump down. Use the control capabilities to turn heating jackets on/off or activate/deactivate valves or pumps and gauges from the comfort of your office.

For More Information

The individual functions of the EWS are described in detail in Chapter 7 of this manual. Consult Chapter 3 for information on menu items related to configuration of the web-interface.

Process Control

Eight channels of process control are a standard feature in the PPM100 controller.

Each channel has a relay closure output and corresponding opto-isolated TTL output signal and may be linked to a variety of input sources with intuitive user-programmable rules. Each channel can be linked to any partial pressure or analog input, the system clock, gauge status or a TTL input trigger signal. Channel Rules apply in AUTO mode, and include all variables required for full process automation, including setpoint (level, polarity and hysteresis), delay settings and audio and front panel notification.

Process Control also includes several opto-isolated TTL level inputs, used to remotely control filament on/off, degas on/off, Electron Multiplier On/Off, keypad lockout, datalogging reset and touchscreen enable/disable functions.

Programmable audio alarms and on-screen text messaging alert the user when process control activity takes place.

During process control, the status of all eight channels can be monitored directly and in real time on the LCD display. Eight dedicated LEDs located below the screen provide across-the-room indication of channel status.

Manual override is available for all channels, making it possible to manually control channel relays and TTL output levels directly from the front panel. Manual relay control makes it possible to use the PPM100 as a standalone controller capable of manually or automatically controlling the operation of any standard vacuum system.

All process control events are automatically time stamped and recorded in memory (Event Log) so they can be reviewed at any time. Use the History button on the Process Control panel to access the Process Control Event Log at any time.

Why Use Process Control?

One of the best ways to improve process yield and reduce system failure is through system automation. This is especially important in complex systems or in systems operated by inexperienced personnel. The process control capabilities of the PPM100

make it unnecessary for the operator to be physically present to open valves and actuate switches at the proper time. In fact, a PPM100 with an embedded web server provides remote control capabilities from anywhere in the world.

Use PPM100 Process Control to...

- Automatically control vacuum components such as valves, heaters, power supplies, shutters and other process equipment.
- Interlock process control operations with external signals that are related to time, pressure, temperature, gauge status, system status, TTL logic levels and other parameters.
- Automatically control pumpdown, venting and load-lock procedures.
- Signal when a process is complete or alert operators to system conditions that require their attention.
- Link process control channels together to create powerful system logic to control a wide variety of functions.
- Perform repetitive operations.
- Use e-mail notification to warn operators about possible system problems over the internet (requires web-interface).
- Track the throughput of single-gas mass flow controllers, by measuring the partial pressure of the components they control.

For More Information

Consult Chapter 5 of this manual for detailed connection, configuration and operation information for PPM100 Process Control. Consult Chapter 3 for information on menu items related to the configuration and operation of the Process Control module.

Front Panel

All PPM100 functions can be manually configured and controlled through the instrument's intuitive front panel graphical interface.

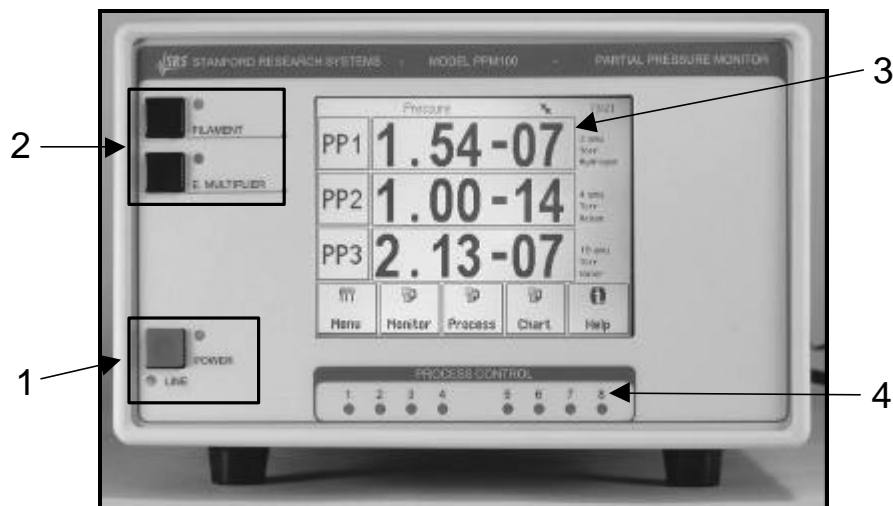

Figure 2-3. The PPM100 front panel.

Front panel components can be divided into five categories (see Figure 2-2) which are described individually in the following sections.

1. Power - LINE LED and POWER button with LED
2. RGA Controls – FILAMENT and E. MULTIPLIER buttons with LEDs
3. Touchscreen/LCD Display
4. Process Control LEDs

Power

LINE LED

The LINE LED (red) lights up to indicate that the PPM100 is connected to, and getting line power from, an AC outlet.

POWER Button and LED

Press the red POWER button to turn the PPM100 ON or OFF.

The green LED, located next to the POWER button, lights up to indicate that the PPM100 is fully powered and completely operational.

Reset

To reset the instrument to its default settings, turn the unit on (using the red POWER key) while holding down the E. MULTIPLIER key. This will erase all user entered parameters!

RGA Controls

FILAMENT Button and LED

Press the black FILAMENT button to turn the RGA filament emission on or off.

The green LED, located next to the button, lights up while the RGA filament is emitting electrons and the unit is reading partial pressures or collecting mass spectra from the RGA Head.

- Filament emission must be turned on in order to acquire partial pressure readings or mass spectra with an RGA.
- The FILAMENT button provides the *only* means to manually control the emission status of the RGA.
- As a general rule, if the RGA electron emission is on, the PPM100 is either collecting (single mass) partial pressure measurements or performing analog scans. The only way to interrupt data collection from the RGA Head is by turning off the filament emission.

Tip

Press the FILAMENT button to interrupt analog scanning at any time and freeze the MassSpec display. This is convenient for analyzing the spectrum. Press the FILAMENT button again to resume MassSpec analog scanning.

E. MULTIPLIER Button and LED

Press the black E. MULTIPLIER button to turn the RGA's electron multiplier on or off during analog MassSpec scans.

The green LED, located next to the button, lights up while the E. Multiplier is active.

- The E. MULTIPLIER button is only active during analog scans. Each Partial Pressure (i.e. single mass) reading has its own individual detector setting.

Touchscreen/LCD Display

The PPM100 has a large backlit, touchscreen /LCD display. The resolution of the display is 320 x 240 pixels. Screen size is 4.7 in. (diagonal)

The LCD displays an intuitive menu-driven interface for instrument setup and operation. The pressure display shows large, easy to read, numeric readings from each gauge as well as bar graphs and trends. Full screen 'Pressure vs. Time' plots are available for all gauges and analog inputs.

Screen contrast is user adjustable and a screen saver is available to extend the life of the fluorescent backlight. A touchscreen calibration is available to align the touchscreen with the LCD display.

Use the Clean Screen menu to desensitize the touchscreen for 20 seconds while cleaning the touchscreen display.

Touchscreen Cleaning Procedure

For best results, use a clean, non-abrasive cloth towel and a commercial window cleaner to regularly clean the screen. The cleaning solution should be applied to the towel, not the surface of the touchscreen. Fluid may seep behind the panel if it is not cleaned properly. Perform the above procedure while the unit is off, or use the Clean Touchscreen menu, described in Chapter 3, to temporarily desensitize the touchscreen of a working instrument.

Process Control LEDs

The green Process Control LEDs are linked to the eight (8) process control channels.

Each LED is associated with a single process control channel and turns on to indicate when its channel output is ACTIVE. The LEDs are broken into two groups of four to facilitate visualization and channel identification from across the room.

Process Control channel status information can be quickly accessed on the LCD display by touching the [Process] QuickKey at any time. However, LEDs make it possible to view channel activities that might otherwise go undetected and have serious consequences on the vacuum system.

Back Panel

The back panel of the PPM100 includes all the electrical connectors required to (1) power and ground the controller, (2) power its gauges, (3) read pressure and analog signals, (4) connect the process control channels (relays and DIGITAL I/O) and remote TTL control pins and (5) interface to a host computer and/or the web.

WARNING!

- Read the entire **Safety and Preparation for Use** section of this manual before using the PPM100.
- Read Chapter 1 for detailed instructions and safety information regarding the installation of the PPM100 and connection to the RGA Head.

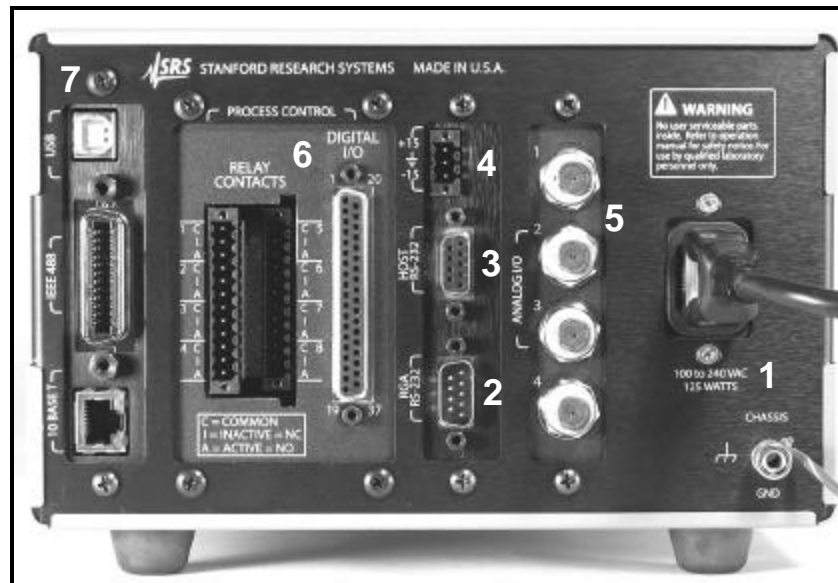

Figure 2-4. The PPM100 back panel.

1. Power - Power Entry Module and CHASSIS GND.
2. RGA RS-232 - RS-232 connection to RGA Head.
3. HOST RS-232 - RS-232 computer interface port.
4. Capacitance Manometer - ± 15 V AUX POWER.
5. Analog I/O - BNC Ports AN1-4
6. Process Control - RELAY CONTACTS and DIGITAL I/O.
7. Computer Interfaces - USB, GPIB, and ethernet 10BASET (Opt 01).

± 15 V AUX Power Connector

Use this 3-pin, ± 15 V (100 mA max), connector to provide electrical power to standard (i.e. non-heated) capacitance manometers.

Process Control

Relay Contacts

Use these two 12-Position Terminal Block Plugs to connect to the eight process control relays. All relays are SPDT, form C, 5A/250VAC/30VDC, resistive load only.

Process Action	Relay Common Connected to	Rear Panel Label
INACTIVE	Normally Closed pin (NC)	I
ACTIVE	Normally Open pin (NO)	A

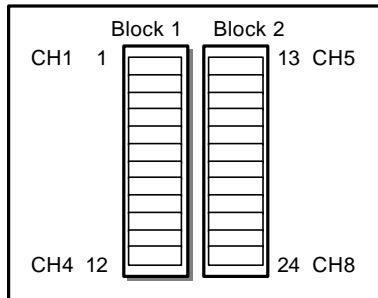

Figure 2-5. The 2 12-position terminal blocks for process relay connections.

Block	Pin	Process Channel	Process Control Label	Relay Pin	
1	1	1	Common (C)	C	
	2		Inactive (I)	NC	
	3		Active (A)	NO	
	4	4	2	Common (C)	C
		5		Inactive (I)	NC
		6		Active (A)	NO
	7	7	3	Common (C)	C
		8		Inactive (I)	NC
		9		Active (A)	NO
	10	10	4	Common (C)	C
		11		Inactive (I)	NC
		12		Active (A)	NO
2	13	5	Common (C)	C	
	14		Inactive (I)	NC	
	15		Active (A)	NO	
	16	16	6	Common (C)	C
		17		Inactive (I)	NC
		18		Active (A)	NO
	19	19	7	Common (C)	C
		20		Inactive (I)	NC
		21		Active (A)	NO
	22	22	8	Common (C)	C
		23		Inactive (I)	NC
		24		Active (A)	NO

DIGITAL TTL I/O

Use the female DB37 port to connect to the (1) eight Process Control TTL Outputs, (2) eight Process Control TTL inputs and (3) seven Remote Control TTL inputs of the Process Control Board. A male DB37 connector is provided to facilitate connection to the controller.

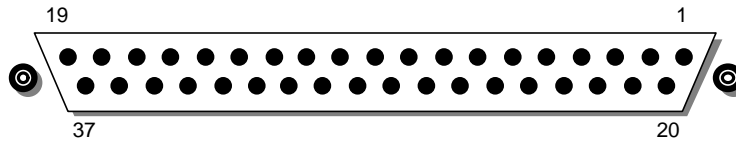

Figure 2-6. The PPM100 DB37 TTL I/O connector.

Module	Pin	Name	Description
	1	PPM100 Vcc	+5 V OUT
Remote Control TTL IN	2	ANODE COM	External User +5 V IN
	3	Not Used	
	4	Not Used	
	5	RGA_Degas	Edge trigger: ↓= Degas On, ↑=Degas Off
	6	RGA_FIL_Lockout	Level: LOW=RGA emission Off
	7	RGA_Key_Disable	Level: LOW=Disable front panel Keypad.
	8	Not Used	
	9	Not Used	
	10	Clear_Data_Log	Edge trigger: ↓=clear the data log
	11	RGA_Remote_Enable	Level: HIGH=Ignore RGA_Degas_On, RGA_FIL_On, RGA_EMULT_On pins.
	12	RGA_FIL_On	Edge trigger: ↓=FIL ON, ↑=FIL Off
	13	Not Used	
	14	RGA_FP_Disable	Level: LOW=Disable Touchscreen and Keypad
		15	PPM100 Vcc
Process Control TTL OUT	16	TTL_OUT_5	TTL OUT for Channel 5. LOW=ACTIVE
	17	TTL_OUT_6	TTL OUT for Channel 6. LOW=ACTIVE
	18	TTL_OUT_7	TTL OUT for Channel 7. LOW=ACTIVE
	19	TTL_OUT_8	TTL OUT for Channel 8. LOW=ACTIVE

Module	Pin	Name	Description
Process Control TTL IN	20	ANODE COM	External User +5 V IN
	21	TTL_IN_1	TTL Input Signal for Channel 1. Active LOW
	22	TTL_IN_2	TTL Input Signal for Channel 2. Active LOW
	23	TTL_IN_3	TTL Input Signal for Channel 3. Active LOW
	24	TTL_IN_4	TTL Input Signal for Channel 4. Active LOW
	25	TTL_IN_5	TTL Input Signal for Channel 5. Active LOW
	26	TTL_IN_6	TTL Input Signal for Channel 6. Active LOW
	27	TTL_IN_7	TTL Input Signal for Channel 7. Active LOW
	28	TTL_IN_8	TTL Input Signal for Channel 8. Active LOW
	29	unused	
	30	PPM100 Ground	
	31	PPM100 Ground	
Process Control TTL OUT	32	COM_EMTR_REF	External User Ground
	33	COM_COLTR_PULLUP	External User +5 V IN
	34	TTL_OUT_1	TTL OUT for Channel 1. LOW=ACTIVE
	35	TTL_OUT_2	TTL OUT for Channel 2. LOW=ACTIVE
	36	TTL_OUT_3	TTL OUT for Channel 3. LOW=ACTIVE
	37	TTL_OUT_4	TTL OUT for Channel 4. LOW=ACTIVE

Note: ↓=HIGH-to-LOW, ↑=LOW-to-HIGH transition.

Process Control TTL OUT

These outputs are opto-isolated from the PPM100. For isolated operation of ALL outputs, connect pin 33 to the external +5 V supply and pin 32 to the external ground. For non-isolated operation of ALL outputs, connect pin 33 to PPM100 Vcc (pin 1 or 15) and pin 32 to PPM100 Ground (pin 30 or 31).

Process Control TTL IN

These inputs are opto-isolated from the PPM100. For isolated operation of ALL Process Control inputs, connect pins 2 and 20 to the external +5 V supply. Pull inputs to external ground for low inputs. For non-isolated operation of ALL Process Control inputs, connect pins 2 and 20 to PPM100 Vcc (pin 1 or 15) and pull inputs to PPM100 Ground (pin 30 or 31) for low inputs.

Remote Control TTL IN

These inputs are opto-isolated from the PPM100. For isolated operation of ALL Remote Control inputs, connect pins 2 and 20 to the external +5 V supply. Pull inputs to external ground for low inputs. For non-isolated operation of ALL Remote Control inputs,

connect pins 2 and 20 to PPM100 Vcc (pin 1 or 15) and pull inputs to PPM100 Ground (pin 30 or 31) for low inputs.

RGA RS-232 Connector

The PPM100 includes a male DB9 connector (RS-232, DTE), labeled RGA RS-232, for serial communication with the RGA Head.

Pin	Signal
1	unused
2	Receive data from RGA
3	Transmit data to RGA
4	unused
5	ground
6	unused
7	handshake from PPM
8	handshake from RGA
9	unused

Figure 2-7. The PPM100 DB9 RGA RS-232 connector.

HOST RS-232 Connector

The PPM100 includes a female DB9 connector (RS-232, DCE), labeled HOST RS-232, for serial communication with a host PC computer.

Pin	Signal
1	unused
2	Transmit data to Host
3	Receive data from Host
4	unused
5	ground
6	unused
7	handshake from Host
8	handshake from PPM
9	unused

Figure 2-8. The PPM100 DB9 RGA RS-232 connector.

Analog I/O

BNC Ports (AN1-4)

Use these four BNC ports to input (or output) analog signals into (or out of) the controller.

All PPM100 controllers have four analog input/output ports (BNC connectors) on the back panel. The range is ± 12 V with 14-bit input resolution and 12-bit output resolution. The update rate is 2 Hz. Each individual port may be configured as an input or as an output for complete I/O flexibility.

Inputs

All inputs are logged in the Data Log, along with all pressure readings. These inputs may be displayed on the Pressure and AnalogIO Displays and are also available in either Table or Chart mode in the Data Log Display.

When used as inputs, these ports can read the output signals from standard capacitance manometers. The PPM100 will display the readings as pressures provided the full scale range (Pmax) of the gauge and CM Display: Linear are programmed into the controller.

Inputs may be linked to Process Control channels to control relays or TTL outputs.

Outputs

All output voltages may be set manually or linked logarithmically to a partial pressure reading.

When an output port is linked to a partial pressure (PP1 through PP8), the analog output behaves as follows:

$$P \text{ (Torr)} = 10^{V-14} \text{ for } 10^{-13} \text{ Torr} \leq P \leq 10^{-4} \text{ Torr}$$

0 V indicates gauge off
12 V indicates gauge fault

For More Information

Consult Chapter 4 of this manual for a complete description of the Analog I/O capabilities of the PPM100, including specifications, connections, possible configurations, and capacitance manometer operation. Chapter 3 all menus required to configure the PPM100 for proper operation of its Analog I/O ports, including direct pressure display from capacitance manometers.

Maintenance and Service

1. The PPM100 does not have any user-serviceable parts and requires minimum routine maintenance.
2. Do not perform any unauthorized service, adjustment or modification of the controller.
3. Do not install any substitute parts.
4. Consult the 'Damage Requiring Service' section of this manual for instructions on how to return the instrument for authorized service and adjustment.

Chapter 3

Displays and Menus

The PPM100 has a menu driven, touchscreen user interface. To activate an on-screen button, simply touch the LCD display over the button area.

There are 7 main display screens – Pressure, Monitor, AnalogIO, MassSpec, Logging, Process Control and Menus. These displays are the primary interface to your vacuum system. The Pressure Display presents three pressures (partial or total) or analog input readings in a large, easy to read format. The Monitor Display shows up to eight partial pressure readings on a single display panel (including alarm information). It also provides access to the AnalogIO and MassSpec displays. The AnalogIO display shows the voltage levels at the analog I/O ports and also up to four capacitance manometer readings. The MassSpec display is used to graph mass spectra directly on the front panel of the controller. The Logging Display shows the stored Data Log in Table or Chart format. The Process Control Display shows the state of the 8 process control channels and relays. The Menu is used to setup various operating parameters of the PPM100 such as remote interfaces, screen, and time/date settings.

Displays are accessed via the QuickKeys displayed at the bottom of most displays. This allows fast access to the most critical information in the vacuum system. Within each display, the individual Data Boxes where the data is presented are also buttons. For example, touch a box in the Monitor Display to reconfigure a partial pressure data box.

Help for any button or box is available on screen by touching the [Help] QuickKey, then touch any button or box for help about its function. Touch [done] to exit help.

In This Chapter

QuickKeys	3-5	Numeric Entry	3-8
Pressure QuickKey	3-5	Text Entry	3-8
Menu QuickKey	3-5	Action	3-8
Monitor QuickKey	3-5	Time/Date	3-9
AnalogIO QuickKey	3-6	Text Display	3-9
MassSpec QuickKey	3-6		
Process QuickKey	3-6	Pressure Display	3-10
Table/Chart QuickKey	3-6	ID Box	3-10
Auto Scale QuickKey	3-6	Data Box	3-11
History QuickKey	3-7	Big Numbers	3-11
Overview QuickKey	3-7	Trend Graph	3-12
Back to Previous QuickKey	3-7	Silent/Audio Leak Trend	3-12
Help QuickKey	3-7	Auto Scaling Bar Graph	3-13
		Full Range Bar Graph	3-13
Menu Buttons	3-8	Leak Rate	3-13
Submenu	3-8	Status Information	3-13
Choose (multiple choices)	3-8	Info Box	3-14
Choose (two choices)	3-8	Pressure Units	3-14

3-2 Displays and Menus

Monitor Display	3-15	Time Length of Log	3-33
Partial Pressure Data Box	3-15	Chart Y Axis Menu	3-34
Monitor/Setup Menu		Pmax Pmin	3-34
(Partial Pressure Setup Parameters)	3-16	Vmax Vmin	3-34
PP1 - PP8 Measurement	3-16	Autoscale	3-34
PP1 - PP8 Mass (amu)	3-17	Chart X Axis Menu	3-35
PP1 - PP8 Correction Factor	3-17	Chart Time Range	3-35
PP1 - PP8 Name	3-17	Zoom to Cursor	3-35
Set via library	3-17	Scale to Full	3-35
PP1 - PP8 Scan Rate	3-18	Process Control Display	3-36
PP1 - PP8 Detector	3-18	About Process Control	3-36
Alarm	3-18	Active vs Inactive	3-37
Alarm Submenu	3-19	Process Control History	3-37
PP1 - PP8 Alarm Status	3-19	Process Control Overview	3-37
PP1 - PP8 Alarm Level High	3-19	Channel Data Box	3-38
PP1 - PP8 Alarm Level Low	3-19	Auto/Manual Channel Control	3-38
Pressure	3-19	Edit Rules Menu	3-39
Alarm Beep	3-19	Linked To	3-39
AnalogIO Display	3-20	Pressure Setpoint	3-40
About Capacitance Manometers	3-20	Voltage Setpoint	3-40
Analog Signal Data Box	3-21	Setpoint Activation	3-40
Capacitance Manometer Data Box	3-21	Percent Hysteresis	3-40
Monitor/AnalogIO/Setup Menu (Analog I/O		Voltage Hysteresis	3-41
and CM measurement setup)	3-23	Delay	3-41
ADC or DAC	3-23	Gauge Off/DAC State	3-41
CM Pmax (P@10V)	3-24	Activation Time Deactivation Time	3-41
AN1-4 (CM1-4) Name	3-24	Activate When TTL	3-42
DAC Source	3-25	Edit Messages Menu	3-43
Volts When Source=Manual	3-25	Description	3-43
CM Display	3-25	Active Message Inactive Message	3-43
Zero CM Submenu	3-26	Beep	3-44
MassSpec Display	3-27	Main Menu	3-45
Cursor	3-28	Units	3-45
Moving the Cursor	3-28	SRS	3-45
M Init	3-29	RGA Menu	3-46
M Final	3-29	Electron Energy (eV)	3-46
Y Axis	3-29	Ion Energy	3-46
Y Axis Submenu	3-29	Focus Voltage (V)	3-46
Pmax	3-29	Electron Current (mA)	3-47
Pmin	3-29	Scan Rate	3-47
Logging Display	3-30	Calibrate Electrometer	3-47
Chart	3-30	RGA Info	3-47
Moving the Cursor	3-30	Advanced Submenu	3-48
Changing the Graph	3-31	Degas	3-48
Table	3-31	Ionization Source	3-48
Logging Setup Menu	3-32	RF7 Error Handling	3-49
Display Format	3-32	Leak Rate Coefficient	3-49
Logging	3-32	Utilities Menu	3-50
Display Date	3-32	Time/Date	3-50
Logging Interval	3-33	Volume Control	3-50
TTL Reset Enable	3-33	Configuration	3-50

Selftest Submenu	3-51	Control Submenu	3-57
System Selftest	3-51	Web Control	3-57
Button & LED Test	3-51	Security Type	3-57
Xmit via RS-232	3-51	Password	3-58
Remote Menu	3-52	Trusted IPs	3-58
System Name	3-52	Start Trusted Range End Trusted Range	3-58
RgaQueue	3-52	Trusted IP Address	3-58
RS-232 Submenu	3-53	USB Submenu	3-59
Baud Rate	3-53	USB Queue	3-59
Word Length	3-53	Screen Menu	3-60
Parity	3-53	Contrast Up Contrast Down	3-60
Flow Control	3-53	Clean Touch Screen	3-60
RGA Pass Through	3-53	Calibrate Touch Screen	3-61
RS-232 Queue	3-54	Test Touch Screen	Error! Bookmark not defined.
GPIB Submenu	3-54	Backlight Menu	3-62
Address	3-54	Backlight Saver	3-62
GPIB Queue	3-54	Backlight Delay	3-62
Web Submenu	3-55	TurnOff Time Turnon Time	3-63
Web Server	3-55		
IP-Address	3-55		
Subnet Mask	3-55		
DNS	3-56		
Gateway	3-56		
Web Queue	3-56		
Port Number	3-56		

QuickKeys

Each display includes up to five QuickKeys lined up across the bottom of the screen. The QuickKeys presented in the main Pressure Display (below) provide fast access to the most important displays – Menu, Monitor, Process, Table/Chart and Help. Within any of these other displays, the QuickKeys may provide access to additional display modes. In each case, use the Pressure or Back QuickKeys to return to the Pressure Display.

Use the Pressure Display as the main starting point in operating the PPM100.

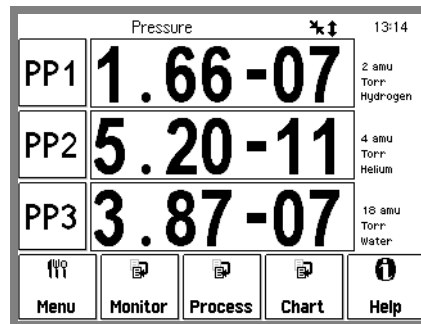

Figure 3-1. Pressure Display.

Pressure QuickKey



Show the main Pressure Display screen. The Pressure Display has three Horizontal Data Bars, each displaying a pressure (or analog input). Readings may be displayed in various formats and are updated twice a second.

The Pressure QuickKey is available in most displays other than the Pressure Display.

Menu QuickKey

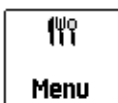

Access the PPM100 Menu. Use the Menu to modify important PPM100 and RGA parameters such as units, communications, clock, touchscreen, backlight, audio, RGA ionizer settings, etc.

The Menu QuickKey is available *only* in the Pressure Display.

Monitor QuickKey



Access the Monitor Display. The Monitor Display shows up to eight partial pressure readings on a single screen including alarm and RGA status information. Touch an individual Partial Pressure Box (PP1-PP8) to modify its partial pressure measurement settings.

The Monitor QuickKey is available *only* in the Pressure display.

AnalogIO QuickKey



Show the AnalogIO Display. The AN Display consists of: (1) four data boxes for analog signals (top row, AN1-AN4) and (2) four data boxes for CM readings (bottom row, CM1-CM4). Touch an individual data box to modify its measurement parameters and/or the I/O properties of its port.

The AnalogIO QuickKey is available *only* in the Monitor display.

MassSpec QuickKey



Access the Analog MassSpec Screen. The Analog Scan Screen provides the only way to display mass spectra generated by the SRS RGA Head directly on the front panel of the PPM100.

The MassSpec QuickKey is available *only* in the Monitor display and *only* displays spectra if *all* process control channels are in a manual state.

Process QuickKey

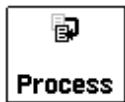

Show the Process Control Display. The Process Control Display shows the current state of the eight (8) process control channels. Touch an individual Channel Data Box to control a channel or modify its configuration.

The Process QuickKey is available *only* in the Pressure display.

Important

Process Control is performed through an 8-channel Process Control board standard in all PPM100 controllers. Each channel includes a relay closure output, with corresponding opto-isolated TTL output. While in AUTO mode, each channel can be linked to any partial or total pressure reading, any analog input, the system clock, RGA status or a TTL input trigger signal through user-programmable Rules. The Process Control Display allows editing of channel Rules and Labels, as well as manual control of all channels.

Table/Chart QuickKey

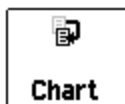

Display the Data Log in either Table or Chart format. Use the [Setup] button to choose the Default Display format, Table or Chart, and other data logging parameters.

The Table/Chart QuickKey is available *only* in the Pressure Display.

All PPM100 controllers include Data Logging. When Data Logging is enabled, data from the RGA, capacitance manometers and analog inputs are stored in a circular memory buffer at the rate specified by the programmed logging interval.

Auto Scale QuickKey



Autoscale the Y axis of the graph based on the data currently displayed.

History QuickKey



Display the Process Control History log.

This key is available *only* in the Process Control display.

The PPM100 logs all important controller, RGA and process control related events (manual/auto, de/activation) in a memory buffer. Use the information stored in the log to track and diagnose system problems.

Important

The History log is preserved if the PPM100 is turned off using the front panel power button. However, all records are lost if power is removed by unplugging the unit from the wall .

Overview QuickKey



Display a complete Process Control Overview. Use the Overview to quickly review the state and rules for all process control channels in a single display screen.

The Overview QuickKey is *only* displayed in the Process Control display.

Back to Previous QuickKey

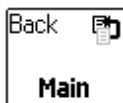

Return to the previous menu screen indicated in the button.

Help QuickKey

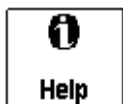

On-screen Help provides information on the operation of the PPM100. Help information is available for menus, buttons, displays and hardware.

To display help on an item...

first... touch the Help QuickKey at the bottom-right corner of the screen. The button becomes highlighted.

next... touch the button or box you wish to learn about. The screen changes to the Help Display Window and help text is displayed.

then... use the [up] and [down] buttons to scroll through the text. Touch [done] to return to normal operation.

or... touch [More] for a list of related topics. Choose a topic in the list to display its help.

then... use [back] to display previous topics and [forward] to return to later topics.

Menu Buttons

The PPM100 uses various types of menu buttons identified by the icon in the upper right corner.

Submenu

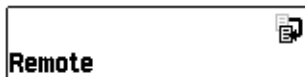

Display a submenu.

Use the submenu to access setup parameters that do not fit (or belong) on the top menu.

Choose (multiple choices)



Display a multiple choice selection list.

Touch an item from the list to choose it.

Choose (two choices)



Display a two choice selection list.

Touch one of the two items on the list to choose it.

Numeric Entry

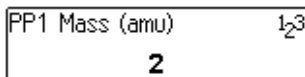

Display the numeric entry keypad.

Enter a parameter value using the touchscreen keypad, then touch [accept] to store it. The parameter valid range and current units are shown in the numeric entry box. Touch [cancel] to quit entry with no change.

Text Entry

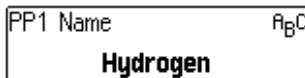

Display the text entry keypad.

Enter a text string using the touchscreen keypad, and touch [ok] to store it. Touch [abort] to quit entry with no change.

Action



Perform the indicated action.

Touch the button to perform the action indicated. Further instructions may be presented on the screen.

Time/Date

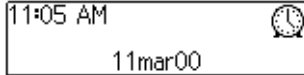

Display the Time/Date entry keypad.

Enter the new time and date and touch [accept] to store the new settings. Touch [cancel] to quit entry with no change.

The clock is used ...

- to log pressure readings (data log)
- to log process control events (process history)
- to log gauge activity (gauge history)
- to trigger process control events at specific times.

The clock requires adjustment after daylight savings corrections take place.

Text Display



Display text data.

Touch the button to display text data on the screen. The text display includes scroll up/down and page up/down buttons.

This button is used to display large amounts of text information, such as annotated Data Log event entries (Table display format) and PPM100 configuration information (Utilities submenu).

Pressure Display

Use the Pressure Display as the main starting point in operating the PPM100. Use the [Pressure] or [Back to Pressure] QuickKeys to bring up the Pressure Display.

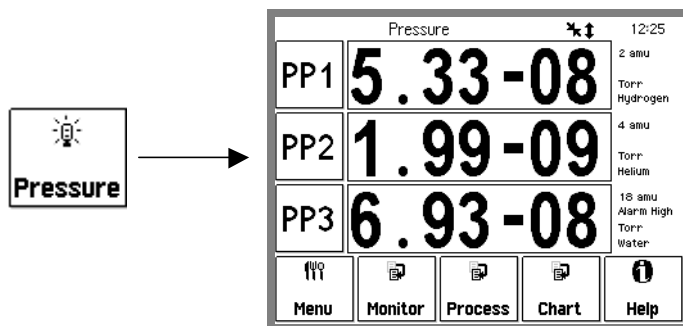

Figure 3-2. Use the [Pressure] QuickKey to bring up the Pressure Display.

This display has three horizontal Data Bars, each displaying a measurement from a pre-selected source (i.e. RGA, CM or analog signal). Readings may be displayed in various formats and are updated twice a second.

Customize a Data Bar by touching the ID Box (left), the Data Box (center) or the Info Box (right).

The QuickKeys presented in the main Pressure Display provide fast access to the most important displays – Menu, Monitor, Process, Table/Chart and Help. Within any of these other displays, new QuickKeys may provide access to additional displays. In each case, use the Pressure or Back QuickKeys to return to the Pressure Display.

ID Box

PP1

The ID Box identifies the source of the readings in the Data Bar. The data source can be the RGA, a capacitance manometer or an analog signal.

Touch the ID Box to display a list of available data sources - partial pressure: PP1-PP8, capacitance manometer: CM1-CM4 and analog signal: AN1-AN4. Select a data source for the Data Bar.

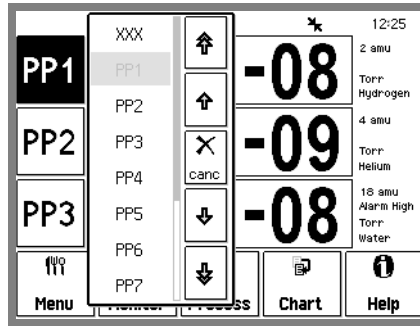

Figure 3-3. Choosing a source for the top data bar.

Important! Even though only three readings can be simultaneously displayed on the Pressure display, PPM100 constantly monitors and logs ALL analog I/O ports, ALL enabled partial pressure readings, and ALL enabled capacitance manometer readings..

Data Box

1.24-06

The Data Box displays the readings from the selected source.

Touch the Data Box to choose one of the eight display formats.

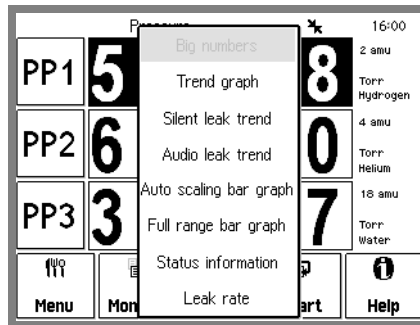

Figure 3-4. Choosing a display format for the middle data bar.

Big Numbers

PP1 5.96-08 2 amu
Torr Hydrogen

Figure 3-5. Big Numbers data display.

Best display for accurate, easy to view, pressure readings. Easily visible across the room.

Trend Graph



Figure 3-6. Trend Graph display.

Best display for trend analysis. A stamp-sized 'P vs. Time' plot of the most recent readings. It also includes a small instantaneous reading next to the plot. Use trend graphs to see pressure changes in time-dependent processes such as leak testing, pump downs, venting, bakeout, etc.

Silent/Audio Leak Trend

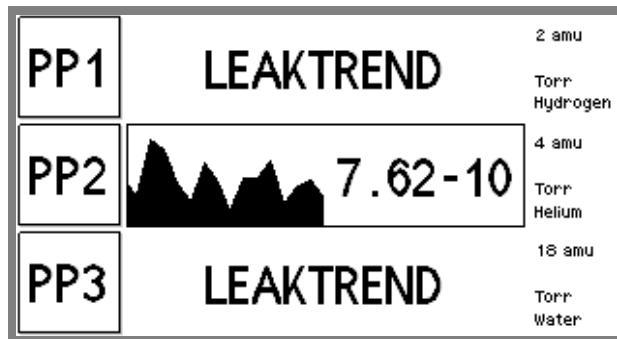

Figure 3-7. Leak Trend Graph display.

Best display for leak detection applications (see “Leak Testing with the PPM100” in Chapter 1). Use this display while leak testing components attached to the vacuum system. Use leak trend graphs to detect leaks as partial pressure transients while spraying the vacuum system components with a tracer gas such as helium or argon.

A stamp-sized 'Signal vs. time' plot of recent partial pressures for the selected mass is displayed. A small instantaneous partial pressure reading is also included next to the plot.

When 'Audio Leak Trend' is selected, an audio signal whose frequency is proportional to the partial pressure readings provides a means to “hear” pressure transients, eliminating the need to look at the front panel display while searching for leaks.

To provide optimum data acquisition rates at the selected mass, all other partial pressure readings and displays are disabled while in this display mode. The other Data Bars will show "LEAKTREND" until a non-LeakTrend display is chosen for this Data Bar.

Warning!

All process control channels must be in manual mode to be able to access the Silent Leak Test Display mode.

Auto Scaling Bar Graph



Figure 3-8. Auto Scaling Bar graph.

Best display to detect instantaneous changes in pressure readings. Three decade logarithmic bargraph display scaled about the current reading. Often used during leak testing procedures. This display preserves the 'feel' of the old analog needle displays preferred by some vacuum users.

Full Range Bar Graph

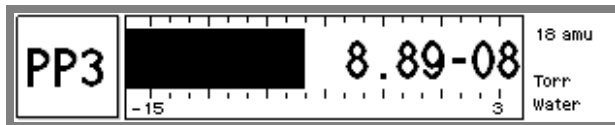

Figure 3-9. Full Range Bar Graph display.

Best display to view the overall status of your vacuum system at any given time. Fifteen decade logarithmic bargraph display, covering the entire useful range of the instrument (10^{-12} to 10^3 Torr). The scale covers the entire range from UHV to atmosphere.

Leak Rate

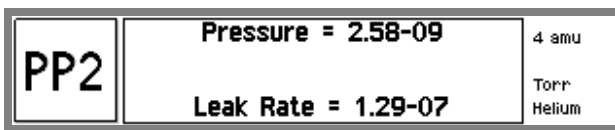

Figure 3-10. Full Range Bar Graph display.

Select this option to display leak rates calculated from the partial pressure reading and the system's user-specified Leak Rate Coefficient.

$$\text{Leak Rate} = \text{Partial Pressure} \times \text{Leak Rate Coefficient}$$

Status Information

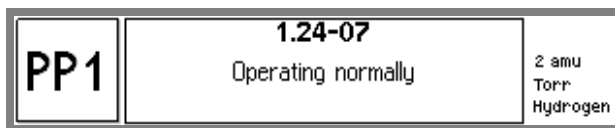
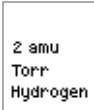

Figure 3-11. Status Information display.

Use this display to learn more about the state of a data source. This is especially useful if the gauge is in a fault or error condition.

Info Box



The Info Box shows additional information related to the measurement.

Touch the Info Box to access the Measurement Setup Parameters for the displayed data. This allows easy access to all setup parameters for the displayed measurement. For example, touch the Info Box of a PP1 Data Bar to access its partial pressure measurement setup parameters (i.e. PP1 monitor/setup screen).

The Info Box includes ...

- gas mass (in amu)
- gas, gauge or port name
- units (pressure or voltage)
- CM Display
- Analog I/O mode

Pressure Units

The factory default for pressure units is Torr (1 Torr = 1 mm Hg). To change the units of the Pressure Display, use the Menu QuickKey, then touch [Units] in the menu. Choose a units system – Torr, micron, bar, mbar, or Pascal. All three Data Bars use the same units system.

Monitor Display

Use the [Monitor] or [Back to Monitor] QuickKey to bring up the Monitor Display.

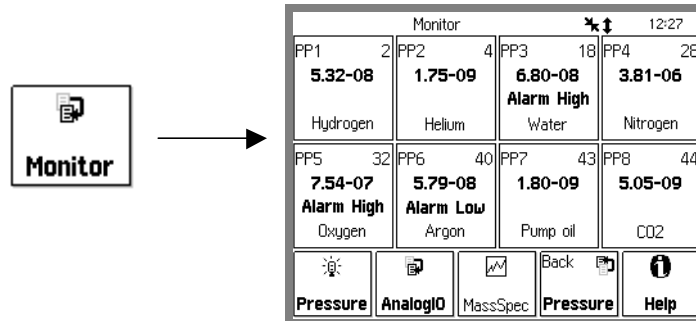
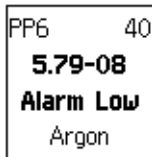

Figure 3-12. Monitor Display.

The Monitor display consists of eight rectangular Partial Pressure Data Boxes (PP1-PP8), each displaying a single mass partial pressure measurement from the RGA Head. Gas name, gas mass (in amu), alarm status and important RGA status information are also included in each box.

Touch a Partial Pressure Box to access its Monitor/Setup menu, and display the Partial Pressure Setup parameters for that measurement.

Partial Pressure Data Box



Each Partial Pressure Data Box displays a single-mass partial pressure reading originating from the RGA head (and usually corresponding to the partial pressure contribution from a single gas to the mixture's total pressure.)

Each Partial Pressure Data Box contains four lines of information (top to bottom):

- ID Label: PP1-PP8 source identification labels (shared by both Monitor and Pressure Displays) and gas mass (amu units).
- RGA Reading/Status: Partial pressure reading or RGA Head status.
NO DATA is displayed when partial pressure measurements are disabled for the box.
LEAKTREND is displayed if any Data Bar in the Pressure Display is in Silent or Audio Leak Trend mode.
- Alarm/ Display Status: **Alarm High/Low** is displayed (and the controller beeps intermittently) when measurements and alarms are enabled and a level alarm condition is met. **Disabled** is displayed on this line when partial pressure readings are disabled for this box.
- Gas name: The name of the gas associated to the single mass being measured is displayed on this line.

Touch a Partial Pressure Data Box to display its Monitor/Setup menu, and edit its partial pressure setup parameters.

Monitor/Setup Menu (Partial Pressure Setup Parameters)

WARNING!

Read the entire **Safety and Preparation for Use** section of this manual before using the PPM100.

Read Chapter 1 for detailed instructions and safety information regarding the installation and connection of gauges.

Each partial pressure measurement (PP1-PP8) has its own setup menu and measurement parameters. Access the Monitor/Setup menu of a partial pressure measurement to modify its Setup Parameters: (1) from the Monitor Display, touch a Partial Pressure Data Box or (2) from the Pressure Display, touch the Info Box of the corresponding partial pressure Data Bar.

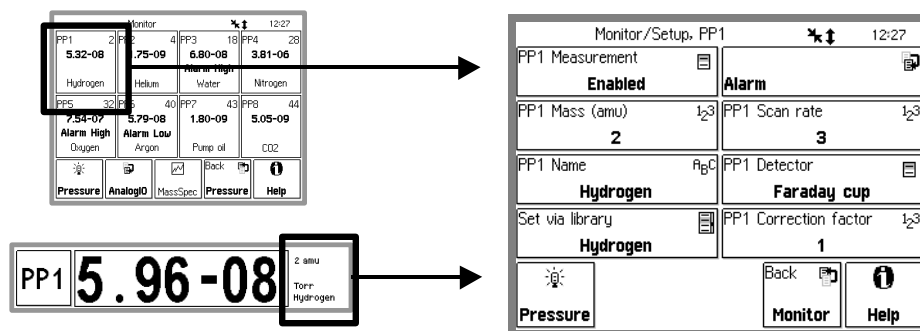

Figure 3-13. Monitor Setup Menu.

For More Information

Chapter 1 includes all the installation and setup information required to set up your PPM100 controller and its gauges.

PP1 - PP8 Measurement

Enable or Disable the partial pressure measurement (and display) for the selected partial pressure data box (or data bar.)

When a partial pressure reading is disabled (i.e. skipped) 'NO DATA' is shown in place of the partial pressure readings. 'Disabled' is also shown in the partial pressure box in the Monitor Display.

Tip

PPM100 can display up to 8 independent partial pressures in its Monitor Display screen. However, not all partial pressure readings need to be enabled at all times. It is sometimes useful to limit the number of partial pressures continuously monitored and stored by the PPM100 to increase sampling frequency for the species of interest or to store partial pressure measurement settings for common gases not present in the current mixture.

PP1 - PP8 Mass (amu)

Enter the mass, in amu, for the selected partial pressure measurement. The minimum mass is 1 and the maximum is the mass range of the RGA head (100, 200 or 300).

The SRS RGA head can measure individual peak heights on the mixture's mass spectrum at any integer mass within its mass range. Peak height readings (i.e. ion currents) are transmitted back to the PPM100 and converted into partial pressure readings for the specified single mass.

Warning

Partial pressure measurements for the channel are disabled if the specified mass exceeds the mass range of the RGA head.

PP1 - PP8 Correction Factor

Enter a Gas Correction Factor value (0.01 to 100) for the selected partial pressure measurement.

The SRS RGA head can measure individual peak heights on the mixture's mass spectrum at any integer mass within its mass range. Peak height readings (i.e. ion currents) are transmitted back to the PPM100 and converted into partial pressure readings for the specified single mass. A single sensitivity factor (calibrated for Nitrogen gas @28 amu) is used to convert all ion current readings into partial pressures. Use correction factors to display partial pressure readings for other gases- i.e. the Gas Correction Factor is used to convert nitrogen-equivalent pressure readings into direct readings for other gases. The nitrogen-equivalent pressure reading is **multiplied** by the gas correction factor and displayed as the partial pressure. Use a value of 1.0 when detecting nitrogen.

PP1 - PP8 Name

Enter the gas name for the selected partial pressure measurement. This name is displayed in the partial pressure data boxes.

The SRS RGA head can measure individual peak heights on the mixture's mass spectrum at any integer mass within its mass range. Peak height readings (i.e. ion currents) are transmitted back to the PPM100 and converted into partial pressure readings for the specified single mass. Most often the single mass peak being monitored is associated to a single-gas, and the partial pressure readings track its contribution to the total pressure of the mixture.

Set via library

Select a gas name from the list [Hydrogen, Helium, Water, Nitrogen, Oxygen, Argon, Pump Oil, CO₂, Methane, Neon, Krypton].

Pre-loaded [gas name, mass] pairs are available for the most common residual gas components present in vacuum applications. Select a gas from the list to configure the partial pressure Name and Mass.

PP1 - PP8 Scan Rate

Choose a Scan Rate for the selected partial pressure measurement.

The Scan Rate sets the measurement time for the selected partial pressure measurement.

As a rule-of-thumb, a decrease in the Scan Rate setting results in (1) lower baseline noise, (2) better detection limits but (3) increased measurement time.

The Scan Rate setting is transmitted to the RGA Head prior to each partial pressure measurement.

Consult the SRS RGA Manual for complete details on the noise floor (NF) setting of the RGA Head (Scan rate = NF + 1).

PP1 - PP8 Detector

Choose Faraday cup or Electron Multiplier detector for the selected partial pressure measurement.

Use the Electron Multiplier to increase the RGA's sensitivity, improve its detection limit or simply provide faster readings. Limitations associated to the Electron Multiplier are: limited dynamic range, mass discrimination effects, gain instabilities and finite lifetime of the device.

Consult the SRS RGA Manual for full details on detector selection criteria.

Alarm

Level alarm warnings can be programmed for each individual partial pressure measurement.

Alarm control and level settings are modified through the Alarm submenu.

When a Level Alarm is enabled, the PPM100 sounds an audible alarm, and displays an **Alarm** prompt in the appropriate partial pressure box, every time: (1) the pressure drops below the "Alarm level low" or (2) the pressure rises above the "Alarm level high".

Important!

The alarm levels are independent from, and must not be confused with, the partial pressure limits used by process control rules. However, process control channels can also be programmed to activate every time an alarm is tripped for any of the partial pressure measurements.

Recommendation

Use the Level Alarms to call attention to over/under-pressure conditions while you are not close to the controller.

Alarm Submenu

Display the Level Alarm Setup submenu for the selected partial pressure measurement.

PP1 - PP8 Alarm Status

Select level alarms enabled or disabled for the selected partial pressure measurement.

Choose Disabled to interrupt alarm notification and beeping.

Important

Partial Pressure measurement level alarms are independent from, and must not be confused with, the partial pressure levels that can be associated to process control channels.

PP1 - PP8 Alarm Level High

Enter a value (1e-14 to 1e+5) for the alarm level high.

When a Level Alarm is enabled, the PPM100 sounds an audible alarm, and displays an Alarm prompt in the appropriate partial pressure box, every time: (1) the pressure drops below the “Alarm level low” or (2) the pressure rises above the “Alarm level high”.

PP1 - PP8 Alarm Level Low

Enter a value (1e-14 to 1e+5) for the alarm level low.

When a Level Alarm is enabled, the PPM100 sounds an audible alarm, and displays an Alarm prompt in the appropriate partial pressure box, every time: (1) the pressure drops below the “Alarm level low” or (2) the pressure rises above the “Alarm level high”.

Pressure

The current partial pressure reading is displayed for convenience while setting the alarm levels.

Alarm Beep

Enable or disable the alarm beep. When the alarm is on, a beep is sounded as long as the alarm condition is satisfied.

AnalogIO Display

WARNING!

Read the entire **Safety and Preparation for Use** section of this manual before using the PPM100.

Read Chapter 1 for detailed instructions and safety information regarding the installation and connection of gauges.

Access the AnalogIO Display from the Monitor Display by touching the AnalogIO [QuickKey].

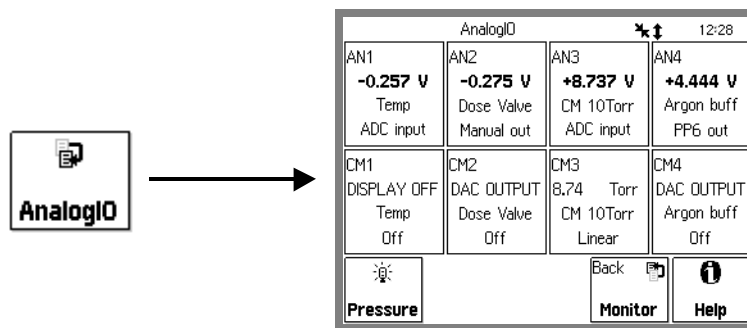

Figure 3-14. AnalogIO Display.

The AnalogIO display shows the voltage levels (input or output) at the four analog I/O ports and also up to four capacitance manometer pressure readings. It consists of two rows of four data boxes:

- (1) Top Row - Analog Signals: AN1-AN4 Boxes
- (2) Bottom Row - Capacitance Manometer Readings: CM1-CM4 Boxes

Touch a Data Box to display its Setup menu, and edit its measurement parameters.

About Capacitance Manometers

Capacitance Manometers (CMs), also known as capacitance diaphragm gauges, are the most accurate devices for measuring absolute and differential pressures of gases and vapors at the gauge's operating temperature. CM gauge heads are specified by their full scale pressure (Pmax). The gauge output is a dc voltage linearly related to the pressure. By industry standard, the output is 10 Vdc at Pmax. Dynamic range is typically 10^4 .

Most gauge heads require ± 15 Vdc (35 mA) to operate. Heated head assemblies require much higher power, and some models require higher voltages. Consult the gauge manual for power requirements and maximum pressure specifications. Most manufacturers list the maximum pressure, power requirements and connector pinouts right on the gauge body.

The PPM100 has a ± 15 Vdc (100 mA) output connector on the back panel to directly power standard (non-heated) capacitance manometers.

Using capacitance manometers

The PPM100 is designed to read pressures from up to four capacitance manometers. To read CM pressures, the CM output signal must be connected to one of the four Analog I/O ports on the back panel. The analog port must be configured as an ADC input in the Analog I/O Setup menu. The full scale pressure of the CM (Pmax) must be set before pressure readings are correct. CM Display must be set to Linear to properly scale the pressure measurements.

CMs need to be periodically re-zeroed. A trim pot is built into most gauge heads for that purpose. However, if the trim pot is out of reach, use the Zero Manometer function in the Analog Setup menu.

For More Information

Chapter 1 includes all the basic information required to install and set up your PPM100 controller and its gauges, including capacitance manometers. Consult Chapter 4 of this manual for further details on the operation of capacitance manometers and their proper connection to Analog I/O ports.

Analog Signal Data Box

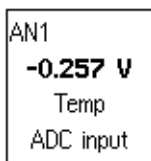

Each Analog Signal Data Box (top row, AN1-AN4) displays a voltage level at an analog I/O port. For example, AN1 displays the voltage signal (input or output) at the ANALOG I/O port labeled 1 on the back panel of the PPM100

Each Analog Signal Data Box contains four lines of information (top to bottom):

- ID Label: AN1-AN4. For example, the AN1 Box displays voltage signals at the analog I/O port labeled 1 on the back plane of the PPM100.
- Voltage level: Voltage level (input or output, in Volts) at the port.
- Port Name: A unique name assigned to the physical port connection by the user.
- I/O Mode: Each port can be individually configured as input (ADC Input), manual output (Manual out) or PP1-PP8 linked output (PP1-8 out).

Touch an Analog Signal Data Box to display its Setup menu (Monitor/AnalogIO/Setup, AN1-4), and edit its measurement setup parameters.

Capacitance Manometer Data Box

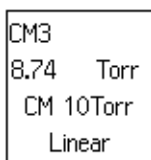

When properly configured, each Capacitance Manometer Data Box (bottom row, CM1-4) can display a total pressure calculated from the analog voltage measured at the corresponding ANALOG I/O port. For example, CM1 can be used to display CM Pressures calculated from the voltages measured at the AN1 Analog Port. Capacitance manometers must be connected to Analog I/O ports configured as inputs. For direct pressure readings program the full scale pressure (Pmax) and set CM Display to Linear.

Each CM Data Box contains four lines of information (top to bottom):

- ID Label: CM1-CM4. For example, the CM1 Data Box can display pressures calculated from the input voltage levels measured at the ANALOG I/O port labeled 1 on the back plane of the PPM100.
- Pressure reading/DISPLAY OFF/DAC OUTPUT: CM pressures are displayed if the analog port is set to ADC input, Pmax is properly programmed and CM Display is set to Linear or Log. DISPLAY OFF replaces the pressure readings if CM Display is set to OFF. DAC OUTPUT is displayed if the port I/O mode is set to DAC output.
- Gauge Name: A unique name can be assigned to each CM gauge by the user.
- CM Display: Linear, Log or Off. Linear is required to assure proper pressure calculations for Capacitance Manometers. Off indicates that no pressure calculations are performed from the analog voltages at that ANALOG I/O port. Log indicates that a logarithmic relationship between voltage and pressure is assumed for the calculation of pressures for the gauge connected to the port (this extends the use of the CM Data Boxes to display pressures from compact gauges with logarithmic pressure outputs).

Touch a Capacitance Manometer Data Box to display its Setup menu (Monitor/AnalogIO/Setup, AN1-4) and edit its measurement setup parameters.

Monitor/AnalogIO/Setup Menu (Analog I/O and CM measurement setup)

WARNING!

Read the entire **Safety and Preparation for Use** section of this manual before using the PPM100.

Read Chapter 1 for detailed instructions and safety information regarding the installation and connection of gauges.

Access the Monitor/AnalogIO/Setup menu from (1) the AnalogIO Display (touch an Analog Signal or Capacitance Manometer Data Box) or (2) from the Pressure Display (touch the Info Box of an Analog signal or a Capacitance Manometer Data Bar).

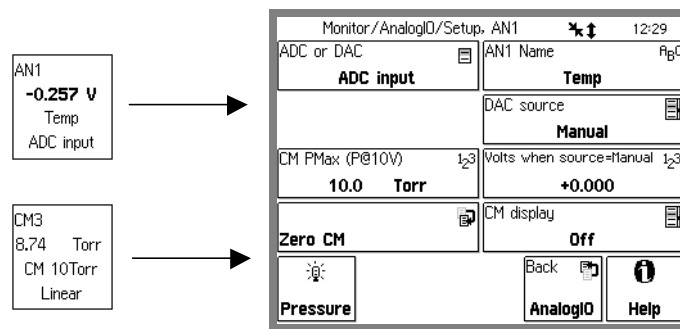

Figure 3-15. AnalogIO Setup Menu.

Each analog I/O port (AN1-AN4) and each Capacitance manometer (CM1-CM4) has its own setup menu. For any given port, both menus share the same settings.

ADC or DAC

Configure the analog I/O port as either an ADC Input or a DAC Output.

ADC Input

When ADC Input is selected, the analog port is connected to a 14 bit, ± 12 V full-scale, Analog-to-Digital Converter updated at 2 Hz. Input signals can be monitored through the Pressure Display (choose ID: AN1-4 or CM1-4) or the AnalogIO Display (top row).

Inputs may be linked to Process Control channels to control relays or TTL outputs.

All inputs are logged in the Data Log, along with all partial pressure readings.

Use analog inputs to read voltages from additional vacuum equipment such as capacitance manometers, thermocouples, mass flow controllers, turbo pump controllers, etc.

Capacitance manometers must be connected to Analog I/O ports configured as inputs. For direct pressure readings program the full scale pressure (Pmax) to match your gauge and set CM Display to Linear.

DAC Output

When DAC Output is selected, the analog port is connected to a 12 bit , ± 12 V full-scale, Digital-to-Analog Converter updated at 2 Hz.

Each DAC port may be programmed manually or linked to the log partial pressure readings, PP1-PP8 (DAC Source). This provides logarithmic analog outputs compatible with programmable logic controllers and data loggers.

Use analog outputs to control auxiliary vacuum equipment such as heaters, actuators, ion sources and throttle controllers.

CM Pmax (P@10V)

Enter the full scale range of the capacitance manometer (0-1000 Torr) connected to the port.

Note

The full scale ranges most commonly encountered in commercial CM gauges are 50 and 100 mTorr, and 1, 2, 10, 100 and 1000 Torr.

Important

Analog I/O ports connected to capacitance manometer signals must be configured as inputs (ADC Input) for pressure measurement to be possible. Direct pressure readings are possible only if PMax is programmed into the controller, and CM Display is set to Linear.

AN1-4 (CM1-4) Name

Enter a unique name for the analog I/O port and the CM Gauge.

The PPM100 assigns a unique name (text string) for each signal port. Location names are displayed in the ID Box of the Pressure Display and also in the Data Boxes of the AnalogIO Display. The same name is shared by both the AN and CM Data boxes linked to a common port.

The default location is the name of the port ("AN1" or "CM1").

Note

Use the Location name to differentiate between identical gauges in multiple gauge setups. For example, consider a vacuum system with two identical CM gauges- one connected to the High Vacuum Chamber (and the AN1 port) and the other one connected to the Rough Line (and the AN2 port). In this case, give the gauge connected to AN1 (CM1) the name "HiVac" and the CM2 gauge the name "Rough". This labels the two readings with meaningful names.

DAC Source

Link the DAC output to one of the partial pressure readings (PP1-PP8) or choose Manual for front panel output level control.

The analog outputs may be linked to the log of the partial pressure readings. These signals are often connected to devices such as programmable logic controllers, throttle valve controllers, and other common feedback controlled instruments.

When PP1-PP8 is the DAC source, the analog output follows these parameters.

$$P \text{ (Torr)} = 10^{V-14} \text{ for } 10^{-14} \text{ Torr} \leq P \leq 10^{-4} \text{ Torr}$$

0 V indicates gauge off
12 V indicates gauge fault

When Manual is the DAC source, the analog output is set with the [Volts when source=Manual] menu button.

Volts When Source=Manual

Enter the voltage setting for the DAC Output when Source=Manual. The valid range is ± 12 V.

Tip

The actual output voltage is measured and displayed in the Analog Signal Data Box (AnalogIO Display).

CM Display

Select a pressure calculation method for CM pressure readings. The options are: Linear, Log or Off.

Linear assumes a linear relationship between the pressure and the voltage output of the gauge. Pmax (P@10V) is the pressure corresponding to 10 Vdc output signal, and is used to scale all pressure readings for the gauge. This mode **must** be selected for standard capacitance manometers with linear outputs.

Log assumes a logarithmic relationship between the pressure and voltage output of the gauge. Pmax is the pressure corresponding to 10 V output, and a 1V/decade logarithmic relationship between voltage signal and pressure is assumed over the entire range of the gauge. This mode is compatible with many standard compact gauges with logarithmic voltage outputs and 1V/decade scaling.

Off turns pressure calculation off for that port. No CM pressure is displayed in the CM Data Box. This condition indicated in the fourth line of the CM Data box.

Tip

Use the Log mode to display pressures from compact gauges providing a logarithmic voltage output signal.

Zero CM Submenu

Adjust the Capacitance Manometer (CM) Zero indication.

Follow the on screen directions to adjust the zero of the capacitance manometer gauge.

Periodic Zero readjustments of the capacitance manometer readings, to compensate against background drift, are required for operation close to base pressures.

Important

Before making this adjustment, the CM must be connected to a vacuum system with a pressure lower than 0.01% of full scale ($0.0001 \times P_{Max}$).

Trim Pot Zero Adjustment

All capacitance manometers include a trim pot adjustment, used to adjust the output of the CM to zero at base pressure. Use the trim pot adjustment regularly to adjust the internal zero of the capacitance manometer head. The standard trim pot adjustment procedure is simple:

1. Connect the CM to a vacuum chamber with a pressure $<0.01\%$ of P_{Max}
2. Switch the PPM100 to the AnalogIO Display.
3. If necessary, configure the analog port connected to the CM as an ADC input, set its CM Display to linear and program its P_{max} setting to match that of the gauge.
4. Turn the trim pot until the voltage displayed in its Analog Signal Box is zero.
5. Perform a Zero CM operation to adjust the PPM100 zero.
6. The AnalogIO and CM readings should be zero at the base pressure conditions.

MassSpec Display

WARNING!

Read the entire **Safety and Preparation for Use** section of this manual before using the PPM100.

Read Chapter 1 for detailed instructions and safety information regarding the installation and connection of gauges.

Access the MassSpec Display from the Monitor Display by touching the MassSpec [QuickKey].

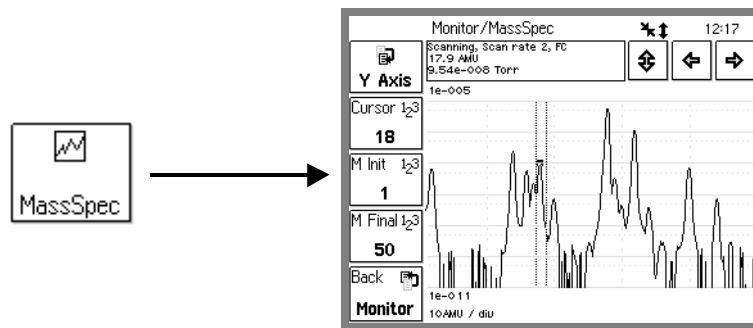

Figure 3-16. RGA MassSpec Display.

The MassSpec Display provides the only way to graph mass spectra, generated by the SRS RGA head, directly on the front panel of the PPM100.



Analog scanning is the most basic operation of the SRS RGA as a quadrupole mass spectrometer. During analog scanning the quadrupole mass spectrometer is stepped at fixed mass increments (0.1 amu) through a prespecified mass range. The ion current is measured after each mass-increment step and transmitted to the PPM100 over RS-232. Analog scanning simplifies the detection of mass peaks for individual component gases, and provides a direct view of the peak shapes and resolution of the instrument.

WARNING!

No single mass partial pressure readings take place while the PPM100 is in the MassSpec Display. As a result, all process control channels must be switched to a safe manual state before the MassSpec Display can be accessed. Partial pressure readings resume when the MassSpec Display is exited.

The MassSpec Display Screen consists of four main areas:

1. QuickKeys: Five QuickKeys located on the left side of the MassSpec Display provide fast access to important analog scan settings– Y Axis scaling, Cursor Position, Initial Scan Mass , Final Scan Mass, and Back button. Use the Back button to exit this display.

2. Info Box: A small rectangular box located above the mass spectrum graph area, displays [mass, partial pressure] reading pairs for mass peaks at the current cursor position and also provides relevant RGA status information.
3. Cursor and AutoScale Buttons: Press  to autoscale the Y axis based on the currently displayed data. Press   to move the mass spectrum cursor to the left or right (in 1 amu increments) and find the exact mass position and height of peaks throughout the spectrum.
4. Mass Spectrum Graph Area: This is the actual area where the mass spectrum is displayed. The mass range extends from Initial Mass to Final Mass. Logarithmic Y-Axis scaling takes full advantage of the large dynamic range of the RGA. Pmin and Pmax are displayed below and above the graph, respectively.

If not already on, press the FILAMENT button to establish electron emission and activate the acquisition and display of mass spectra.

Press the FILAMENT button again to turn off the filament and stop analog scanning. The most recent full mass spectrum is preserved on the screen for analysis.

Electron Multiplier

- **Wait for electron emission to be established in the RGA head before pressing the E. MULTIPLIER button.**
- Press the E. MULTIPLIER button to activate the electron multiplier detector during analog scans, and improve the detection limit of the SRS RGA.
- The electron multiplier can only be turned on if the filament is already on and emitting electrons.
- The electron multiplier is shut down if the filament is turned off during a scan.
- The electron multiplier is shutdown when the MassSpec Display is exited.

Tip

Use the Analog MassSpec Display mode to identify and select single masses during the Partial Pressure Measurement setup.

Cursor

Enter a new destination mass (in amu) for the cursor or track the location of the cursor while using the left and right cursor arrows.

Moving the Cursor

There are 3 ways to move the cursor:

1. Enter a destination mass with the Cursor button.
2. Move the cursor in 1 amu increments using the left and right cursor arrows.

3. Touch and select the Info Box above the graph and then touch the right half of the spectrum to move the cursor to the right, the left half to move it to the left. Touch close to the center to move slowly, at the edges to move quickly. Touch and hold to move continuously.

Every time the cursor is moved to a new position (± 1 amu increments), the exact mass and pressure of maximum amplitude at that position is displayed in the info box. Use this feature to identify gas species and test the mass axis calibration of the RGA.

M Init

Specify the initial mass value (in amu) for the analog scan.

The lower mass limit for this number is 1 amu. The upper mass limit depends on the SRS RGA model number: 100 for RGA100, 200 for RGA200 and 300 for RGA300.

M Final

Specify the final mass value (in amu) for the analog scan.

The lower mass limit for this number is 1 amu. The upper mass limit depends on the SRS RGA model number: 100 for RGA100, 200 for RGA200 and 300 for RGA300.

Y Axis

Logarithmic scaling of the mass spectra Y Axis in the MassSpec Display takes full advantage of the RGAs dynamic range.

Touch the Y Axis [QuickKey] in the MassSpec Display to access the Y Axis SubMenu.

Note

A new analog scan is triggered when exiting the Y Axis SubMenu.

Y Axis Submenu

Display the Y Axis submenu for the MassSpec Display.

Pmax

Set the pressure corresponding to the top of the mass spectrum.

Pmax is displayed above the mass spectrum graph area

Pmin

Set the pressure corresponding to the bottom of the mass spectrum.

Pmin is displayed below the mass spectrum graph area

Logging Display

Use the [Table] or [Chart] QuickKey to bring up the Logging Display. The data log is presented in either Table or Chart display formats. Select the format in the Logging Setup menu. This also changes the QuickKey between [Table] and [Chart].

The logged data for the three data bars in the Pressure Display are displayed in a single screen. All inputs are logged – to display different data, choose new sources in the Pressure Display (ID Boxes).

Chart

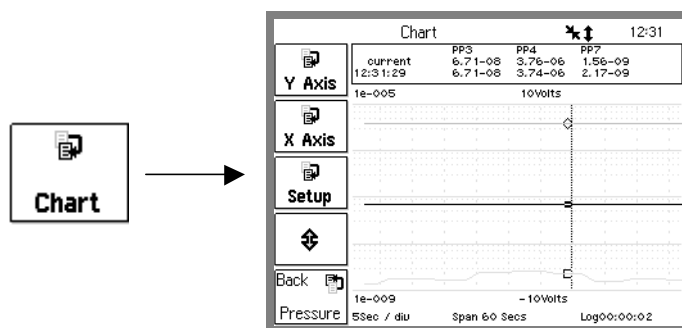

Figure 3-17. Chart Display.

Display the data log in graphical (P or V vs. Time) format.

The small table above the chart displays the most recent entry and the readings at the cursor position.

Pmax and Vmax are displayed above the graph, Pmin and Vmin below the graph.

The right edge is the most recent data point and the left edge is a Time Range ago. This resembles a chart recorder with new data appearing at the right edge. The X axis scale, span and logging interval are shown at the very bottom of the screen.

Touch [Setup] to display the Logging Setup menu. Touch [Y Axis] or [X Axis] to change the chart scales and time scale.

Moving the Cursor

To move the cursor, first touch the cursor readout above the graph (it highlights with a box). Touch the right half of the chart to move the cursor to the right, the left half to move it to the left. Touch close to the center to move slowly, farther from center to move quickly. Touch and hold to move continuously.

Changing the Graph

The chart scale parameters can be modified within the chart display. To adjust the graph scales, first touch the displayed scale parameter (it highlights with a box). For Pmax, Pmin, Vmax and Vmin, touch the upper half of the chart to adjust the parameter up, the lower half to adjust the parameter down. For the Time Range, touch the left half of the chart to increase the range, the right half to decrease the range. In both cases, touch close to the center to make small changes, farther from center for large changes.

Touch [Y Axis] or [X Axis] to change the chart scales and time range numerically. Touch [Setup] to display the Logging Setup menu.

Table

Table			
Time	PP3	PP4	PP7
12:32:09	6.61-08	3.76-06	2.05-09
12:32:07	6.68-08	3.76-06	2.05-09
12:32:05	6.68-08	3.76-06	2.05-09
12:32:03	6.68-08	3.76-06	2.35-09
12:32:01	6.65-08	3.78-06	2.35-09
12:31:59	6.65-08	3.78-06	2.35-09
12:31:57	6.65-08	3.78-06	2.07-09
12:31:55	6.69-08	3.75-06	2.07-09
12:31:53	6.69-08	3.75-06	2.07-09
12:31:51	6.69-08	3.75-06	1.56-09
12:31:49	6.69-08	3.75-06	1.56-09
12:31:47	6.71-08	3.76-06	1.56-09
12:31:45	6.71-08	3.76-06	1.56-09
12:31:43	6.71-08	3.76-06	1.74-09
12:31:41	6.70-08	3.74-06	1.74-09

Figure 3-18. Table Display.

Column 1: The absolute time (and date) at which the readings were logged.

Columns 2, 3, 4: Pressure or voltage readings from the three Data Bars of the Pressure Display.

Use the up and down buttons to scroll through the entire log. Touch [Setup] to display the Logging Setup menu.

Logging Setup Menu

Touch [Setup] in either the Table or Chart Display to show the Logging Setup menu.

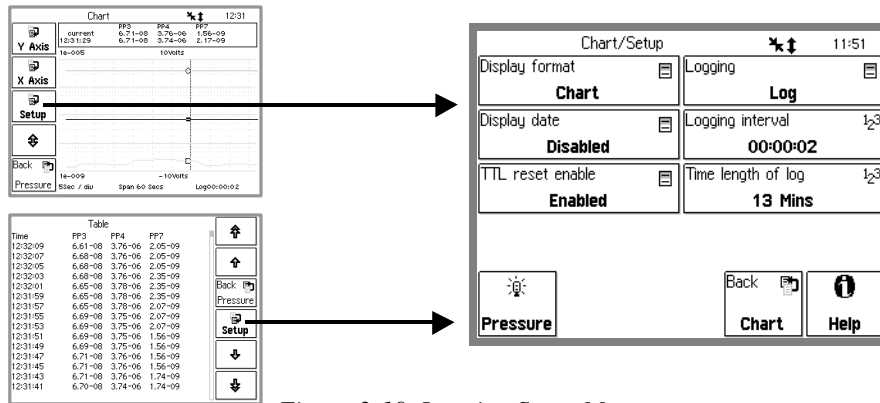

Figure 3-19. Logging Setup Menu.

Display Format

Select the log display format (Table or Chart). This also changes between the [Table] and [Chart] QuickKeys.

Important

The PPM100 always stores readings from *all enabled* data sources in the data log. However, the chart and table only show data from the three measurements shown in the Pressure Display. To display other measurements, change sources in the ID Boxes of the Pressure Display.

Logging

Enable data logging (Log) or disable data logging (Pause).

Display Date

Enable or Disable the Date Display in the Table format.

Enabled means that the date will be included in the time stamp in the Table format display. This requires more lines per entry and fewer entries will be shown per page.

Disabled means that the date will not be included in the time stamp.

Enable this to keep track of the date through data logs that extend over more than one day.

Logging Interval

Enter the Logging Interval.

The Logging Interval is the time between data log entries. For example, a 5 minute setting indicates that a complete set of pressure and analog input readings are added to the data log every 5 minutes.

The Logging Interval affects the time length of the log. The data log stores a fixed number of entries, thus the Time Length of the data log and the Logging Interval are directly related. Use a small Logging Interval to record closely timed data points over a short period of time. Use a large Logging Interval to record data over a long period of time.

TTL Reset Enable

Enable or Disable data logging TTL Time Reset.

Enabled allows the Data Logging Time Reset input of the remote TTL control module to reset the data log.

Enable this to synchronize the start of the data log with an external event, such as the closing of a gate, the opening of a valve or the achievement of full speed in a turbo pump.

Disabled means that the Data Logging Reset input of the TTL control module does not have any effect on the data log.

Time Length of Log

This box displays the Time Length of the data log. This parameter can not be entered directly. The data log stores a fixed number of entries, thus the Time Length is determined by the Logging Interval.

The Time Length is the length of time covered by the data log. After this amount of time, the earliest data in the log will be overwritten by the newest data.

Chart Y Axis Menu

This button is only available from the Chart display.

Pmax

Pmin

Set the pressure corresponding to the top and bottom of the chart.

Note

All pressure readings are displayed with the *same* chart scale. The grid lines correspond to the values of Pmax and Pmin.

Vmax

Vmin

Set the voltage corresponding to the top and bottom of the chart.

Note

Voltage data from the analog I/O inputs is graphed according to Vmax and Vmin. *However, the grid lines correspond to the values of Pmax and Pmin.*

Autoscale

Autoscale the graph based on the data displayed in the graph.

This changes the values of Pmax, Pmin (and Vmax, Vmin) to use the entire vertical space of the chart display.

Chart X Axis Menu

This button is only available from the Chart display.

Chart Time Range

Set the time span of the chart.

The right edge of the chart is the most recent point, the left edge is a Time Range ago. The data moves across the chart as newer points are recorded, resembling a chart recorder.

Zoom to Cursor

Set the left edge of the chart to the cursor position. The right edge remains the most recent point.

Scale to Full

Set the Time Range to display all data points.

Process Control Display

Use the [Process] or [Back to Process] QuickKey to bring up the Process Control Display.

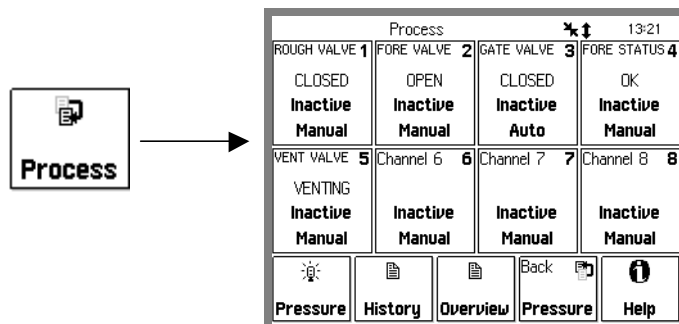

Figure 3-20. Process Display.

This display consists of eight rectangular Channel Data Boxes, each displaying state and mode information for a single process control channel. This display allows fast access to the state and configuration of all process control channels.

Touch a Channel Data Box to choose a channel state (Active, Inactive or Auto) or edit the channel rules and messages.

The 8 dedicated LEDs below the touchscreen provide across-the-room indication of channel output status (On = Active).

WARNING!

Using process control channels in your vacuum system requires careful programming and thorough testing. Double check all logic and wiring and use manual activation to test the action of each and every channel. Test all scenarios in a safe manner before relying on automatic, unattended operation.

About Process Control

The Process Control module provides eight channels of process control. Each channel has a relay closure output, with corresponding opto-isolated TTL signal, that may be linked to a variety of input sources with intuitive user-programmable rules. Channel rules include all variables required for full process automation, including input source selection, activation threshold (level, polarity and hysteresis), delay settings and audio and text notification. The available input sources include any partial pressure or analog input, the system clock, RGA status or a TTL input trigger signal.

This option also includes 7 opto-isolated TTL level inputs for triggering RGA_Remote_Enable, RGA_Filament on/off, RGA_Degas on/off, RGA_Fil_lockout, RGA_Keypad_Lockout, datalog reset and touchscreen enable/disable.

During process control, the output status of all eight channels can be monitored directly from the Process Control Display or remotely via the computer or web interfaces. In addition, the 8 dedicated LEDs below the touchscreen provide across-the-room indication of channel status.

Manual override is available for all channels, making it possible to control channel relays and TTL output levels directly from the front panel.

With its Process control module, the PPM100 can operate as a stand alone controller, capable of manual or automatic operation of any standard vacuum system.

All process control events are time stamped and recorded to be reviewed at any time. The process control log is also accessible remotely through the computer or web interfaces.

Active vs Inactive

When a process control channel is ACTIVE, the corresponding relay is powered, connecting the Common and Active (N.O.) relay pins, and the TTL output pin is logic low. INACTIVE means that the relay is unpowered, connecting the Common and Inactive (N.C.) relay pins, and the TTL output pin is logic high.

When a process control channel is in Auto mode, it becomes Active when the conditions specified by its rule's parameters are met. Rule parameters include setpoint, hysteresis, polarity (above or below), and delay.

Manual control of the channel output is also possible.

Process Control History



All process control events (channels active/inactive/auto) and some RGA related events are time stamped and logged in the Process/History log. Touch the [History] QuickKey to display the contents of the process control event log.

Each line of the log is a change in either State or Mode of a process channel. For state changes (Active/Inactive), the bitfield shows the state of all channels (1=Active, 0=Inactive) starting with channel 1. For mode changes (Auto/Manual), the bitfield shows the mode of all channels (1=Auto, 0=Manual) starting with channel 1.

Important

History event logs are preserved if the unit is turned off using the front panel power switch. However, all records are lost if power is removed by unplugging the unit from the wall.

Process Control Overview



Touch the [Overview] QuickKey to obtain a complete summary report of status and configuration information (including Rules) for all channels in a single screen.

Channel Data Box



A Process Control Data Box displays the state (Active/Inactive), mode (Auto/Manual) and message for a single process control channel. Touch the Data Box to access the channel's rules and messages or to manually control its output.

Each Data Box contains four lines of information (top to bottom):

- Channel Number and Description.
- Channel Active/Inactive Message.
- Output status (Active or Inactive).
- Mode (Manual override or Auto).

Touch a Channel Data Box and choose an option to:

- Switch to Auto mode (channel controlled by its Rules).
- Deactivate the channel (manual override).
- Activate the channel (manual override).
- Edit the channel's Rules (for Auto mode).
- Edit the channel's Messages.

Auto/Manual Channel Control

To control a channel state manually, touch a Channel Data Box and choose 'Active' or 'Inactive'.

To switch a channel to Auto mode (controlled by its Rules), touch a Channel Data Box and choose 'Auto'.

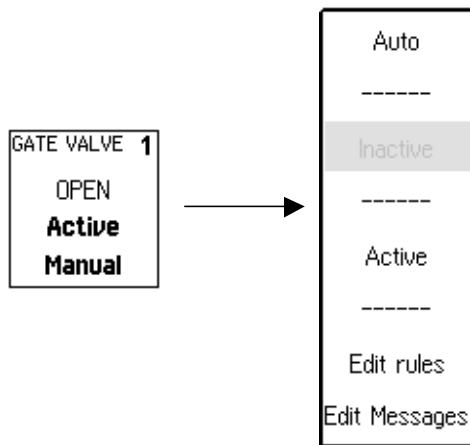

Figure 3-21. Manual Channel control.

Tip

All process channels must be set to a safe manual state, either Active or Inactive, prior to:

- accessing the MassSpec Display
- calibrating the RGA electrometer
- degassing the RGA
- changing the Silent/Audio Leak Trend mode in the Monitor Display

Edit Rules Menu

Access the Edit Rules menu from the Process Control Display (touch a Channel Data Box) and choose 'Edit Rules'.

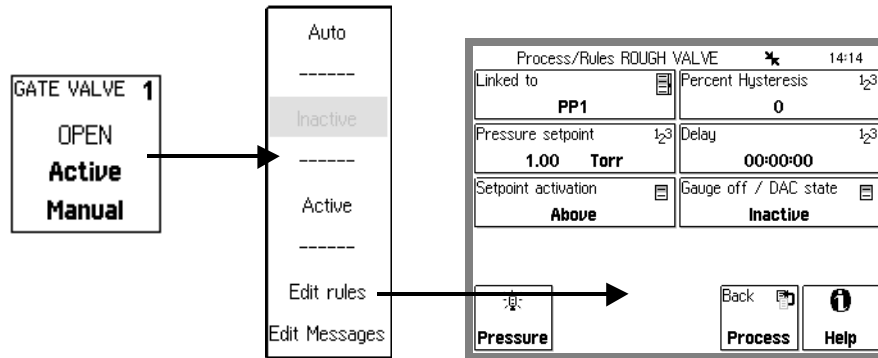

Figure 3-22. Edit Rules Menu.

Each process channel has its own rules. These rules determine the channel state when the channel is in Auto mode.

Linked To

A process control channel can be linked to

- any partial pressure (PP1-8) or capacitance manometer (CM1-4)
 - specify the pressure setpoint, hysteresis, delay and polarity
- any analog input port (AN1-4)
 - specify the voltage setpoint, hysteresis, delay and polarity
- the partial pressure monitor alarm notification system (ALARM)
 - specify the delay
- the system clock (CLOCK)
 - specify the activation and deactivation times
- its corresponding TTL channel input (TTL PIN)
 - specify the polarity and delay

For example, select PP1 to link the channel state to the PP1 partial pressure readings from the SRS RGA Head.

Select ALARM to link a process control channel to the alarm notification system. This process control channel becomes active if **ANY** partial pressure monitor alarm is tripped. Use this as a fail safe rule, to activate the channel if any partial pressure goes beyond acceptable limits.

Pressure Setpoint

Enter the channel Pressure Setpoint (Torr) when the Channel Source is an RGA partial pressure measurement or capacitance manometer gauge (PP1-8 or CM1-4).

The Pressure Setpoint is the pressure threshold at which the channel becomes Active or Inactive. Set the Setpoint Activation to choose Active above or below this threshold. The Setpoint determines the exact level at which channel switching occurs. Use the channel Delay to ignore acceptable pressure transients.

Voltage Setpoint

Enter the channel Voltage Setpoint (Volts) when the Channel Source is an analog input (AD1-4).

The Voltage Setpoint is the voltage threshold at which the channel becomes Active or Inactive. Set the Setpoint Activation to choose Active above or below this threshold. The Setpoint determines the exact levels at which channel switching occurs. Use the Setpoint Delay to ignore transient voltages.

Setpoint Activation

Select the Setpoint Activation for the channel (Above or Below).

Above

The channel becomes ACTIVE when the pressure, or voltage, goes ABOVE the Setpoint.

The channel becomes INACTIVE when

the pressure goes BELOW $\{\text{Setpoint} / (1 + \text{Hysteresis_}\% / 100)\}$

or

the input voltage goes BELOW $\{\text{Setpoint} - \text{Hysteresis_V}\}$.

Below

The channel becomes ACTIVE when the pressure, or voltage, goes BELOW the Setpoint.

The channel becomes INACTIVE when

the pressure goes ABOVE $\{\text{Setpoint} \times (1 + \text{Hysteresis_}\% / 100)\}$

or

the input voltage goes ABOVE $\{\text{Setpoint} + \text{Hysteresis_V}\}$.

Percent Hysteresis

Enter the Percent Hysteresis for the channel (0 to 999 %). Percent Hysteresis applies when the channel is linked to a pressure reading (PP1-8 or CM1-4). See 'Setpoint Activation' above for more information.

Hysteresis allows the process control channel to ignore normal, slow variations or drift in the readings. Use the Delay setting to ignore transient events.

Voltage Hysteresis

Enter the Voltage Hysteresis for the channel (0-12V). Voltage Hysteresis applies when the channel is linked to an analog input (AN1-4). See 'Setpoint Activation' above for more information.

Hysteresis allows the process control channel to ignore normal, slow variations or drift in the readings. Use the Delay setting to ignore transient events.

Delay

Enter the Setpoint Delay time.

The Setpoint Delay is the amount of time that a channel switching condition must be present before channel switching actually takes place.

Use the Setpoint Delay in systems known to experience brief pressure or voltage transients during normal operation. The addition of the delay eliminates unnecessary channel switching.

Gauge Off/DAC State

Specify the channel state (Active or Inactive) when the pressure gauge is turned off, disconnected or in a fault condition (RGA) or when the analog input port is overloaded or (accidentally) switched into DAC Output mode (while linked to CM or AnalogIO).

For Channel Sources PP1-8, specify the desired channel state when the filament emission is turned off or a fault exists (no pressure readings available) or the measurement is disabled.

For Channel Sources CM1-4, specify the desired channel state when its Analog I/O port is switched to DAC Output mode or the input is overloaded (no pressure readings available), or the CM Display is set to Off.

For Channel Sources AN1-4, specify the desired channel state when port is switched to DAC Output mode or the input is overloaded (no voltage readings available).

Activation Time Deactivation Time

Enter the Channel Activation/Deactivation Time when the Channel Source is Clock.

The Activation Time is the exact time at which the channel switches to ACTIVE.

The Deactivation Time is the exact time at which the channel switches to INACTIVE.

All times are represented in 24hr format (18:30 is 6:30pm). The current time is displayed at the top of the screen in most displays.

Use the clock to control scheduled operations such as overnight system bakeouts. The channel Activation Time can start unattended system bakeout an hour after everybody leaves. Use the channel Deactivation Time to stop the bakeout, and allow the system to cool down, three hours before arriving in the morning.

Activate When TTL

Select the TTL Activation mode (High or Low).

Each channel has a dedicated TTL input pin (see Chapter 5). When the Channel Source is TTL, the level of this input controls the channel.

Activate When High means the channel is ACTIVE when the TTL input level is HIGH (and INACTIVE when LOW).

Activate When Low means the channel is ACTIVE when the TTL input level is LOW (and INACTIVE when HIGH).

Edit Messages Menu

Access the Edit Messages menu from the Process Control Display (touch a Channel Data Box) and choose 'Edit Messages'.

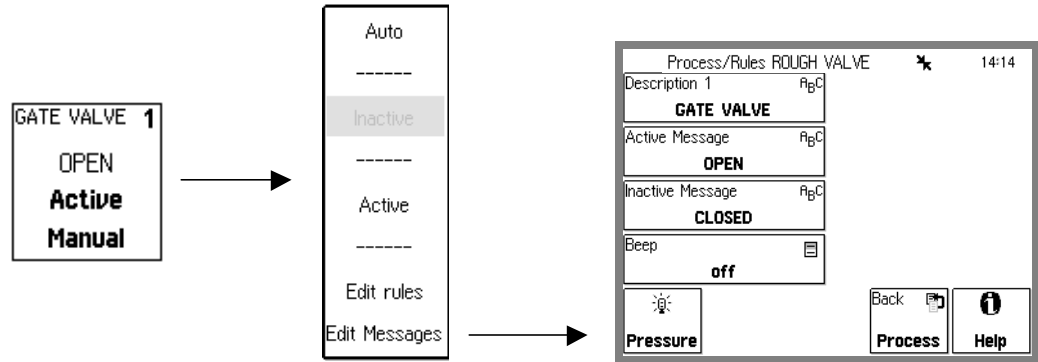

Figure 3-23. Edit Channel Messages Menu.

Each process channel has its own description and messages shown in the Channel Data Boxes. The messages are updated whenever the channel changes state.

Description

Enter a Channel Description.

The PPM100 assigns a Description (text string) to each process control channel. The Description is displayed at the top of each Channel Data Box (next to the channel #).

Assign Description to all channels used for process control. Descriptions such as "heater", or "gate valve" make it easier to visualize and control a system and minimize the chances of errors.

Recommendations

Combine Descriptions and Active/Inactive Messages to provide useful information about the status of your system. For example, for a channel controlling a gate valve (ACTIVE = valve open), use "gate valve" as the Description, "open" for the Active Message and "closed" for the Inactive Message. The Channel Data Box would then display "gate valve/open" or "gate valve/closed" depending on the state of the channel.

Active Message Inactive Message

Enter the channel Messages.

The Active Message is displayed in the Channel Data Box whenever the channel is ACTIVE. The Inactive Message is displayed whenever the channel is INACTIVE.

Recommendations

Combine Descriptions and Active/Inactive Messages to provide useful information about the status of your system. For example, for a channel controlling a gate valve (ACTIVE = valve open), use "gate valve" as the Description, "open" for the Active Message and "closed" for the Inactive Message. The Channel Data Box would then read "gate valve / open" or "gate valve / closed" depending on the state of the channel.

Beep

Enable the Channel Beep (On or Off).

On means that a beep is sounded every time the channel changes states.

Off means that no beep is sounded.

Main Menu

Use the [Menu] or [Back to Main] QuickKey to bring up the Main Menu. This menu can only be accessed from the Pressure Display.

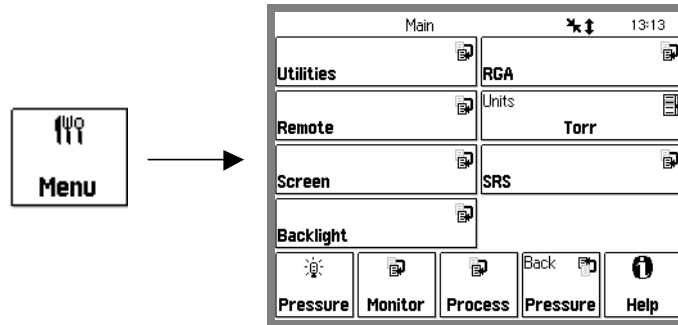

Figure 3-24. Main Menu.

The Main Menu provides access to many important PPM100 internal parameters and settings.

Units

Display the Units selection list.

Select from Torr, Micron, Bar, mbar or Pascal.

This units system is global to the PPM100. All pressure readings in the Pressure Display and data logs use the same units. All pressure parameters in menus use these units.

This button is also available in the numeric entry keypad of pressure parameters.

SRS

Display contact information about Stanford Research Systems, Inc.

RGA Menu

Touch [RGA] in the Main Menu to display and/or modify the RGA Setup parameters.

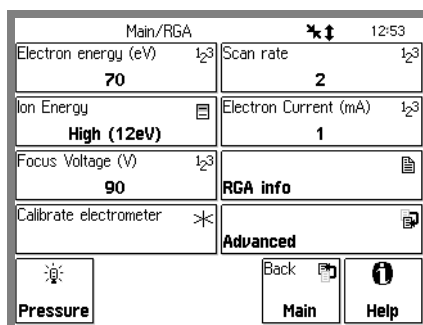

Figure 3-25. Main/RGA menu.

The RGA Setup menu includes all ionizer and detector settings required to configure the RGA head, as well as some advanced settings for specialized applications of RGAs.

The ionizer settings are used by all partial pressure and scanning measurement modes of the PPM100/RGA system.

Important

The detector settings are only used by the Analog Scanning mode (MassSpec Display) since partial pressure readings have individualized detector settings.

Electron Energy (eV)

Adjust the electron impact ionization energy of the ionizer. The parameter represents the desired electron ionization energy in units of eV. The available range is 25 to 105 eV.

The default value is 70 eV.

Ion Energy

Adjust the ion energy to one of two possible settings: Low (8 eV) or High (12 eV).

The default value is High (12 eV).

Focus Voltage (V)

Adjust the focus plate voltage. The available range is 0 to 150 V.

The default value is 90 V.

Note

Careful adjustment of the focus voltage results in optimum coupling of the ion beam into the quadrupole mass filter and maximum sensitivity.

Electron Current (mA)

Adjust the electron emission current in the ionizer. This parameter represents the desired electron emission current in units of mA.

The available range is 0 to 3.5 mA.

The default value is 1.0 mA.

Scan Rate

Adjust the detector's scan rate for analog scanning.

The available range is 1 to 8 (integers only).

The default is 3.

The scan rate parameter represents the desired averaging for the detection and defines the scanning rate and detection limit for mass measurements during analog scans. The scan rate setting is used to set the noise floor (NF) of the RGA during analog scanning (Scan Rate = NF + 1).

In general, smaller scan rates result in reduced background noise, increased signal to noise ratios, improved detection limits and slower scan updates.

Calibrate Electrometer

Perform a complete recalibration of the RGA's electrometer response.

A complete electrometer calibration takes approximately one minute and cannot be interrupted. A count-down timer shows the calibration progress.

The electrometer is designed for maximum long-term stability, however, it is good practice to recalibrate it periodically, particularly in the presence of a large change in the operating temperature or humidity around the RGA Head.

Note

No partial pressure readings can take place while electrometer calibration is in progress. Hence, all process control channels must be switched to a safe manual state before electrometer calibration may be performed.

RGA Info

Display a complete report of all important calibration and timing parameters stored in the RGA head, including error byte values. Use this display to query the RGA head during diagnostic procedures. Have this information handy when contacting SRS for support.

Advanced Submenu

Display the RGA/Advanced submenu.

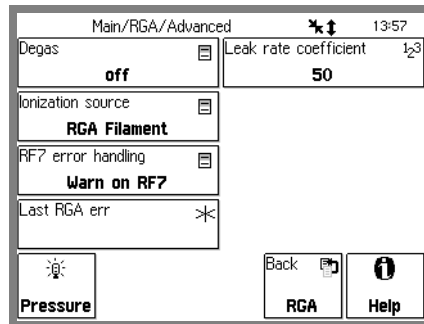

Figure 3-26. Main/RGA/Advanced menu.

Degas

Touch this button to Degas the RGA ionizer by heating and electron stimulated desorption. The Degas time is 3 minutes and a count-down timer shows the progress.

Note

- The filament must already be turned on before degas may be initiated.
- Press the abort button to stop the degas process early.
- No partial pressure readings can take place while RGA degas is in progress. Hence, all process control channels must be switched to a safe manual state before degas may be performed.

Ionization Source

Use this button to select where the ions are formed.

Select RGA Filament to allow partial pressure measurements and analog scanning only if filament emission is present.

Select External to allow partial pressure measurement and analog scanning even in the absence of filament emission.

Tip

Select External if you wish to use the RGA to monitor ions originating somewhere other than the ionizer region, or from an ionization method different from electron impact.

RF7 Error Handling

Select Ignore to ignore RF7 Errors reported by the RGA head.

Select Warn to acknowledge RF7 error reports and prevent the RGA from operating under conditions where unreliable measurements are possible.

Tip

Select Ignore for RGA300 models where RF7 errors are common while the unit is warming up. Consult the RGA's Operating Manual for details on the causes/troubleshooting of RF7 error reports.

Leak Rate Coefficient

Enter a Leak Rate Coefficient for your system. The range is 1 to 3000 and the default is 50.

The Leak Rate Coefficient is used by the PPM100 to calculate and display leak rates (i.e. gas throughput) from partial pressures in the Pressure Display (choose Leak Rate for the data bars).

$$\text{Leak Rate} = (\text{Partial Pressure}) \times (\text{Leak Rate Coefficient})$$

Tip

The Leak Rate Coefficient is often interpreted as the effective pumping speed of the vacuum system for the single gas being measured. For example: If helium is the gas being measured during leak testing and the effective pumping speed of the vacuum system for He is 50 L/sec, a partial pressure of 10^{-10} Torr of He would be displayed as a leak rate of 5×10^{-9} Torr·L·s⁻¹ into the vacuum system. This value is displayed directly in the Pressure Display if the Data Bar for helium is set to Leak Rate.

Utilities Menu

Touch [Utilities] in the Main menu to display the Utilities menu.

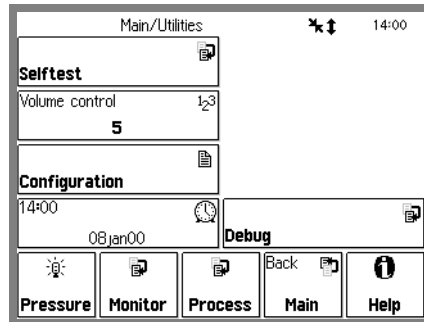

Figure 3-27. Main/Utilities menu.

Time/Date

Adjust the time and date settings of the PPM100.

The clock is used to ...

- log pressure and voltage readings (data log).
- log process control events (process history).
- to trigger process control events at specific times.

All times are represented in 24hr format (18:30 is 6:30pm). The current time is displayed at the top of the screen in most displays.

The clock requires adjustment after daylight savings corrections take place.

Volume Control

Adjust the speaker volume (0 to 10).

The PPM100 speaker is used for different purposes, such as user interface feedback, alarm sounding (during process control and over/under pressure events), or audio leak testing.

Configuration

Display the Configuration Report.

The Configuration Report shows a complete listing of all internal modules detected when the unit was turned on.

Selftest Submenu

Display the Selftest menu.

System Selftest

Touch this button to perform the power-on test again. This also displays the firmware version and date.

Button & LED Test

Touch this button to test the BLACK hardware keys, the 8 process LEDS and the 2 RGA LEDS.

Xmit via RS-232

Transmit the string "SRS PPM100" over the RS-232 interface.

Tip

Use this button to test your RS-232 connection and settings.

Remote Menu

Touch [Remote] in the Main menu to display the Remote menu.

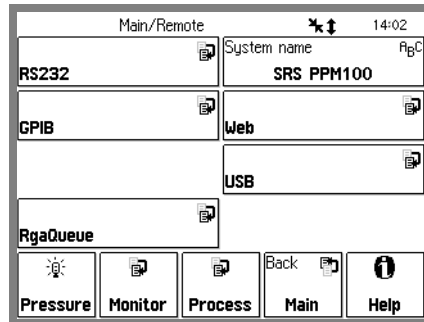

Figure 3-28. Main/Remote menu.

System Name

Enter a system name for this PPM100.

The system name identifies this unit over the remote interfaces. In addition, the name is displayed on all web pages served by this unit.

RgaQueue

Display the RGA RS-232 transmit and receive buffers. The PPM100 buffers the most recent characters received and transmitted over the RGA RS-232 interface, and corresponding to all communications between the PPM100 controller and RGA Head. The Queue display shows the interface history.

The Queue display may slow down communications and should be displayed only when testing or debugging a host program.

Press any QuickKey (other than Help) to exit from this display.

The lower half of the Remote Queue display is the Transmit Queue. These are the most recent commands which have been placed in the output buffer.

The upper half of the Remote Queue display is the Receive Queue. These are the most recent characters which have been received by the PPM100 (displayed in UPPER case) and transmitted from the RGA Head. The RGA sends back both ASCII text and binary characters (not printable as text). The PPM100 user needs to see both to be able to interpret/debug the responses from the RGA head. Each character from the RGA is actually displayed as a three characters set: First the character is displayed (we show a dot if unprintable), this is followed by the two-digit hex representation for it. For example, the sequence “.00.00.00.00” is four bytes of zeros, and the sequence “R52G47A41” is the 3-letter string "RGA" (all upper case, and printable).

RS-232 Submenu

Display the RS-232 configuration menu for the HOST RS-232 interface port..

Baud Rate

Select the RS-232 (Serial) interface Baud Rate [300 – 115.2k].

The available baudrates are: 300, 1200, 2400, 9600, 19200, 28800, 38400, 57600 and 115200.

Word Length

Select the RS-232 (Serial) interface Word Length [7 bits, 8 bits]. 8 bits is standard.

Parity

Select the RS-232 (Serial) interface Parity [None, Even, Odd]. None is standard.

Flow Control

Select the RS-232 (Serial) interface Flow Control [None, Xon/Xoff, Hardware].

None is standard. At high baud rates (>19200), flow control may be necessary to prevent data loss. Check the host serial interface for the type of flow control in use.

RGA Pass Through

Select Pass Through RGA to activate the RS-232 Pass Through Mode of the PPM100.

Select Normal Operation (default) to exit the Pass Through Mode and resume normal PPM100 operation.

While in Pass Through Mode, the PPM100 RS-232 interface passes all data from the host computer directly to the RGA head and all data from the RGA head is passed directly back to the host computer. *The PPM100 RS-232 port uses serial communication parameters identical to the RGA head, not the parameters previously set in this menu.*

WARNINGS!

- All PPM100 Partial Pressure and analog MassSpec measurements are suspended while in the Pass Through Mode.
- All RS-232 communication parameters must be manually restored when the PPM100 is switched back to Normal Operation.
- No partial pressure readings are performed by the PPM100 while in Pass Through Mode. All process control channels must be set to a safe manual state before Pass Through mode is chosen.

Tips

- Pass Through Mode is indicated by the 'P/T RGA connection icon in the upper right portion of the screen.
- Use the Pass Through Mode to communicate with directly with the RGA head, through the PPM100, with a host computer running RGA Windows. In this case, RGA Windows operates as if the host were connected directly to the RGA head.

RS-232 Queue

Display the transmit and receive buffers for the PPM100 HOST RS-232 port. The PPM100 buffers the most recent characters received and transmitted over the interface. The Queue display shows the interface history.

The Queue display may slow down communications and should be displayed only when testing or debugging a host program.

Press a QuickKey to exit from this display.

The upper half of the Remote Queue display is the Receive Queue. These are the most recent characters which have been received by the PPM100 (displayed in UPPER case). Commands which have already been executed are shown in normal text. Commands which have not yet been executed are shown with a gray background. Command errors are shown in inverse text.

The lower half of the Remote Queue display is the Transmit Queue. These are the most recent characters which have been placed in the output buffer. Characters which have already been sent over the interface are shown in normal text. Characters which are waiting to be sent are shown with a gray background.

GPIB Submenu

Display the GPIB (IEEE-488) configuration menu.

This menu also includes a Rx/Tx display button which shows receive/transmit activity on the GPIB port.

Address

Set the PPM100 Device Address.

Before attempting to communicate with the PPM100 over the GPIB interface, the PPM100's device address must be set.

GPIB Queue

Display the GPIB transmit and receive buffers. The PPM100 buffers the most recent characters received and transmitted over the interface. The Queue display shows the interface history.

The Queue display may slow down communications and should be displayed only when testing or debugging a host program.

Press any QuickKey (other than Help) to exit from this display.

The upper half of the Remote Queue display is the Receive Queue. These are the most recent characters which have been received by the PPM100 (displayed in UPPER case). Commands which have already been executed are shown in normal text. Commands which have not yet been executed are shown with a gray background. Command errors are shown in inverse text.

The lower half of the Remote Queue display is the Transmit Queue. These are the most recent characters which have been placed in the output buffer. Characters which have already been sent over the interface are shown in normal text. Characters which are waiting to be sent are shown with a gray background.

Web Submenu

Display the Web server configuration menu.

The parameters in this menu must be entered in order to use the web interface. See Chapter 7 'Embedded Web Server' for step-by-step information on configuring the PPM100 for the internet.

Web Server

Enable or Disable the web server.

Important!

Use the web security measures in the Web/Control menu to prevent unauthorized control of the PPM100 via the web. Disable the server to prevent ALL web access to the PPM100.

IP-Address

Enter the IP Address for the PPM100 web server.

Obtain a valid IP Address from your network administrator. Entering invalid addresses may disrupt your network.

When accessing the PPM100 from your browser, enter this IP address in the address box to display the web pages. Make a 'favorite' to provide one click access.

Subnet Mask

Enter the Subnet Mask for the network. Obtain the appropriate Subnet Mask from your network administrator.

DNS

Enter a DNS Address for the PPM100 web server.

Obtain a valid Domain Name Server (DNS) Address from your network administrator.

The DNS is used by the web server's e-mail notification feature. The DNS allows e-mail addresses to be entered using full domain names.

Gateway

Enter a Gateway Address for the PPM100 web server.

Obtain a valid Gateway Address from your network administrator. The Gateway is used by the web server's e-mail notification feature.

Web Queue

Display the web transmit and receive buffers. The PPM100 buffers the most recent characters received and transmitted over the interface. The Queue display shows the interface history.

Press any QuickKey (other than Help) to exit from this display.

The upper half of the Remote Queue display is the Receive Queue. These are the most recent characters which have been received by the PPM100. The lower half of the Remote Queue display is the Transmit Queue. These are the most recent characters which have been placed in the output buffer. As long as the web server is enabled and functioning properly, there will be continuous traffic on this queue.

Port Number

Change the HTTP port number of the web server. The default port is 80 and should **NOT** be changed except in the following situations.

1. You are using multiple PPM100's in a network behind a NAT (network address translation) router. In this case, all of the PPM100's will appear at the same IP address to the outside world (they will have different IP addresses on the local network). Each PPM100 needs to be on a different port and the router must be configured to forward port requests to the correct PPM100. From the outside, each PPM100 is accessed at its own port number (but the same IP address).
2. If you are experiencing attacks on port 80 that block access to the PPM100. In this case, change the port to something else (like 8080). You will need to specify this port in your browser address window as 208.123.123.32:8080 where 208.123.123.32 is the IP address of the PPM100 and 8080 is the port number.

For more information about NAT routers and ports, see your network administrator.

Wait at least 30 seconds after changing the port number for the change to take effect.

Control Submenu

Display the Web/Control submenu.

The web server can disallow any user from controlling the PPM100 via the web. In this case, only monitoring is allowed from the web.

If web control is required, there are two types of security. Password security requires the user to enter the password from their browser and Trusted IP allows control only to those IP addresses entered in this menu. Both types can be used together.

See Chapter 7 'Embedded Web Server' for more information on configuring the PPM100 for the internet.

Web Control

Enable or Disable web control of the PPM100.

Disabled prevents any user from controlling the PPM100 via the web. In this case, only monitoring is allowed on the web. This provides the most security but only allows monitoring.

Enabled allows both monitoring and control of the PPM100.

Important

There are two types of security. Password security requires the user to enter the password from their browser and IP Checking allows access only to those IP addresses entered in this menu. Both types can be used together. The PPM100 requires the use of at least one type of security.

Security Type

Choose the type of web security (Password, IP Checking or Both)

Password requires the entry of the Web Password from the user's browser before accessing any PPM100 web pages.

IP Checking only allows computers with trusted IP's to access the web server. Only users with static IP addresses can use this feature. Do not use this if you use a dial-up account or DHCP account to access the internet. These accounts have dynamic (i.e. temporary) addresses.

Both requires the password AND a trusted IP address checking before web access to PPM100 is allowed.

The default is Both. Change this setting to Password when using a dial-up connection.

Password

Enter a password for web access.

When accessing the PPM100 web server from your browser, it will ask for this password before any pages will be displayed.

Trusted IPs

Enter trusted IP addresses. When IP Checking security is enabled, the web server only allows access to those IP addresses entered in this menu.

A trusted range of IP addresses allows all users on a local network (or subnet) to access the web server. Use this in a laboratory environment where groups of computers and users are on a single subnet.

Enter individual IP addresses for remote users with static IP addresses outside the trusted range.

IP Checking can not be used with users who have dial-up accounts. These accounts do not have a static, or permanent, IP address.

Start Trusted Range End Trusted Range

Enter the Start and End of the Trusted IP Range.

Trusted IP Address

Enter individual Trusted IP addresses. Up to four individual addresses can be stored in the controller.

USB Submenu

Display the USB (Universal Serial Bus) submenu.

Queue

Display the USB transmit and receive buffers. The PPM100 buffers the most recent characters received and transmitted over the interface. The Queue display shows the interface history.

The Queue display may slow down communications and should be displayed only when testing or debugging a host program.

Press a QuickKey to exit from this display.

The upper half of the Remote Queue display is the Receive Queue. These are the most recent characters which have been received by the PPM100 (displayed in UPPER case). Commands which have already been executed are shown in normal text. Commands which have not yet been executed are shown with a gray background. Command errors are shown in inverse text.

The lower half of the Remote Queue display is the Transmit Queue. These are the most recent characters which have been placed in the output buffer. Characters which have already been sent over the interface are shown in normal text. Characters which are waiting to be sent are shown with a gray background.

Screen Menu

Touch [Screen] in the Main menu to display the Screen menu.

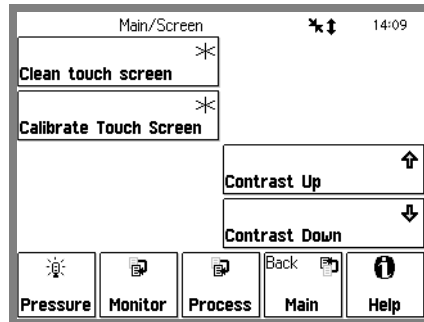

Figure 3-29. Main/Screen menu.

Contrast Up Contrast Down

Adjust the screen contrast according to your viewing needs.

Clean Touch Screen

Display the Touchscreen Cleaning display with countdown timer. This allows the user to clean the screen without turning the power off.

The cleaning display has no touch sensitive areas and can be wiped clean without changing any instrument settings. The touchscreen should be cleaned according to the procedure below and only while the Touchscreen Cleaning display is on (or the unit is off). The timer indicates the time remaining before returning to the menu.

Cleaning procedure

For best results, use a clean, non-abrasive cloth towel and a commercial window cleaner to regularly clean the screen. The cleaning solution should be applied to the towel, **NOT** the surface of the touchscreen. Fluid may seep behind the panel if it is not cleaned properly.

WARNINGS

Do not operate the touchscreen with the tips of pens or sharp objects that might permanently stain or damage the screen surface.

The surface of the touchscreen should be kept free of dirt, dust, fingerprints and other materials that could degrade its optical properties. Long term contact with abrasive materials will scratch the front surface and harm image quality.

Calibrate Touch Screen

Display the Touchscreen Calibration window.

If there is consistent misalignment between the LCD buttons and their touchsensitive areas, follow this calibration procedure to realign the LCD and touchscreen.

Tip

Use the eraser on the end of a pencil to touch the screen. This ensures the best alignment of the LCD and the touchscreen.

Backlight Menu

Display the Backlight saver submenu.

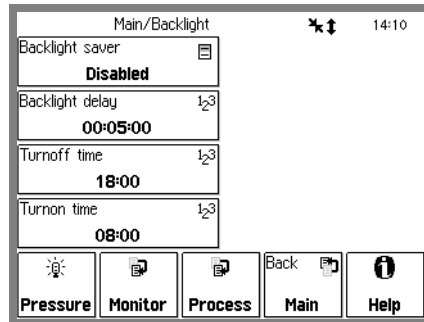

Figure 3-30. Main/Backlight menu.

The PPM100 has a back-lit LCD display. Backlighting is supplied by a fluorescent tube. Use the Backlight Saver feature to extend its useful lifetime by automatically turning it off after hours. Using the Backlight Saver can double the lifetime of the fluorescent tube.

All PPM100 controller functions remain functional while the backlight is off.

Backlight Saver

Select the Backlight Saver mode (Enabled or Disabled).

Disabled means that the backlight will never be turned off.

Enabled means that, between the Turnoff and Turnon times, the display backlight will turn off if the touchscreen is inactive for a period longer than the Backlight Delay. All PPM100 controller functions remain functional while the backlight is off.

Important

Touch the LCD screen to restart the backlight.

Recommendation

Use the Backlight Saver to extend the life of the screen's backlight. Enable the backlight saver mode and program the on/off/delay times to shut off the light overnight.

Backlight Delay

Enter the Backlight Delay time.

If the Backlight Saver is enabled and the time of day is between the Turnoff and Turnon times, then the display backlight turns off if the touchscreen is inactive for the Backlight Delay time.

TurnOff Time Turnon Time

Enter the backlight Turnoff/Turnon Time.

If the Backlight Saver is enabled and the time of day is between the Turnoff and Turnon times, then the display backlight turns off if the touchscreen is inactive for the Backlight Delay time.

Recommendation

Set the Turnoff time to the time at which you leave the lab at night. Set the Turnon time to just before you return in the morning. There is no need to keep the light on when nobody is looking at the screen.

Chapter 4

Analog Input/Output Ports

This chapter includes a complete description of the Analog I/O capabilities of the PPM100, including specifications, connections, possible configurations, and capacitance manometer operation.

In This Chapter

Analog I/O Ports (AN1-AN4)	4-3	Capacitance Manometers (CM1-CM4)	4-6
Connection	4-3	Basics	4-6
Configuration	4-4	CM Connection	4-7
Analog Inputs	4-5	Tips For Using CMs	4-7
Analog Outputs	4-5	Compact Gauges	4-8

Analog I/O Ports (AN1-AN4)

All PPM100 controllers have four analog input/output ports (BNC connectors) on the back panel. Each port can be individually configured as an input or an output from the front panel or through the computer interface.

The specifications are identical for the four ports

Range	± 12 V
Input resolution	14 bits
Input Impedance	1.2 M Ω
Output resolution	12 bits
Output impedance	100 Ω
Update Rate	2 Hz

Connection

The four Analog I/O ports are located on the back panel of the PPM100 and are easily identified as the vertical row of four BNC connectors, labeled ANALOG I/O 1 through 4.

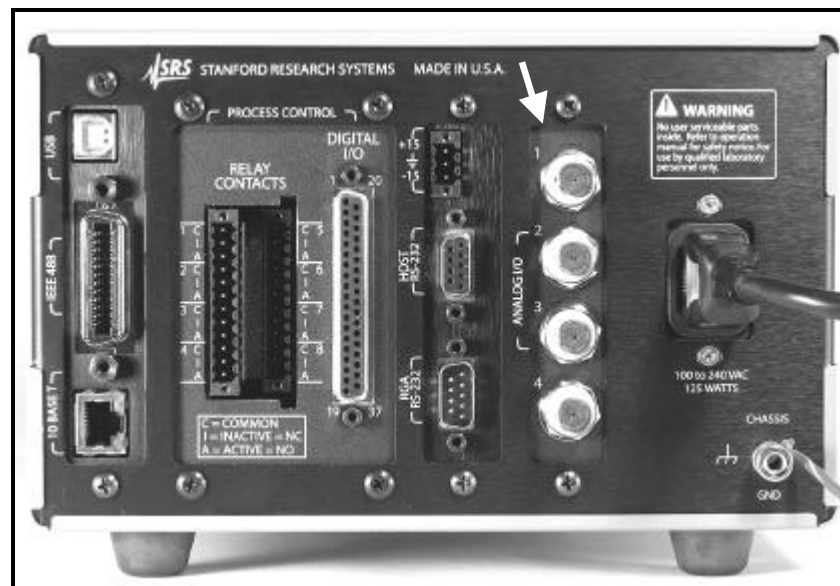

Figure 4-1. Rear panel Analog I/O ports.

The BNC connectors are wired in the standard fashion, with the center pin connected to the signal (input or output) and outer shield connected to the signal return (ground).

Configuration

Each individual Analog I/O port may be programmed to perform one of many possible functions. To configure a port, touch the [Monitor] QuickKey to bring up the Monitor Display. Once in the Monitor Display, touch the [AnalogIO] QuickKey to access the AnalogIO Display. Touch an analog port Data Box (AN1-AN4) to display the Analog Port's Setup menu.

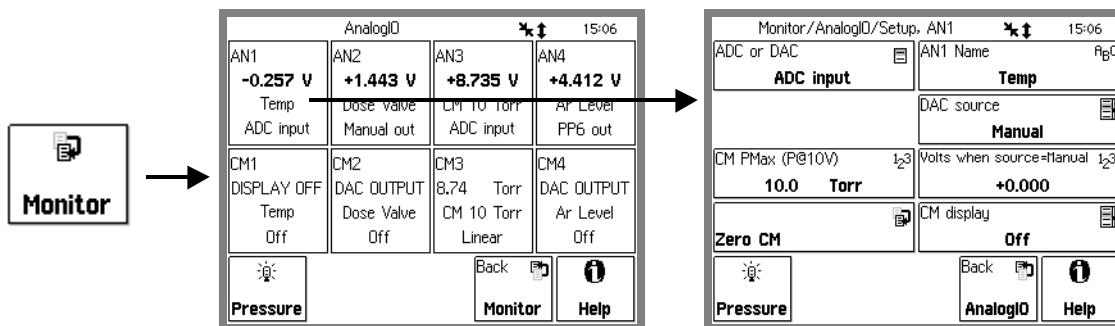

Figure 4-2. Analog I/O Port Setup.

The first, and most important, configuration option is selection of I/O mode, ADC Input (Analog to Digital Converter) or DAC Output (Digital to Analog Converter).

For each analog port connected to a capacitance manometer, CM Pmax must be programmed to the full scale range of the gauge and CM Display must be set to Linear, for CM pressure readings to be properly calculated and displayed in the bottom row of the AnalogIO Display.

For compact gauges, with DC voltage outputs related to the log of the pressure, Pmax must be programmed to the pressure corresponding to 10V output, and CM Display must be set to Log. A 1V/decade relationship between voltage and pressure is assumed over the entire useful pressure range of the gauge.

The level of a DAC output can be set manually (Volts When Source=Manual) or remotely (through the computer interface), or may be linked to the log partial pressure PP1-PP8 (DAC Source).

The PPM100 allows you to assign a descriptive Location name (text string) to each analog port and each capacitance manometer reading. Locations are displayed in the Info Box of the Pressure Display screen, and in the AnalogIO and CM Data Boxes of the AnalogIO Display. This makes it easy to identify the signal source.

For More Information

The menus used for Analog I/O port configuration are described in detail in the Gauges Display section of Chapter 3.

Analog Inputs

When an analog port is configured as an ADC Input, its signal levels (dc voltage or CM pressure) can be displayed on the front panel (Pressure and AnalogIO Display Screens) and/or monitored remotely through the computer and/or web interfaces.

When Data Logging is enabled, all analog input voltages are stored in memory as part of the data log.

Voltage levels beyond the $\pm 12\text{V}$ range display the message 'OVERLOAD'.

Process Control Channels can be linked to ADC Input ports. Channel activation takes place above or below a user specified input signal level. For example, use the amplified voltage readings from a thermocouple gauge to prevent overheating of your sample during inductive heating.

Recommendation

Use Analog I/O ports as inputs to read voltages from additional vacuum equipment such as capacitance manometers, thermocouples, mass flow controllers, turbo pump controllers, throttle valve controllers, etc.

For More Information

Consult the Process Control Display section in Chapter 3 of this manual for information on how to link process control channels to analog input ports.

Analog Outputs

The level of a DAC output can be set manually (Volts When Source=Manual) or remotely (through the computer interface), or may be linked to the log partial pressure PP1-PP8 (DAC Source).

When PP1-PP8 is the DAC source, the analog output follows these parameters.

$$P \text{ (Torr)} = 10^{V-14} \text{ for } 10^{-13} \text{ Torr} \leq P \leq 10^{-4} \text{ Torr}$$

0 V indicates gauge off
12 V indicates gauge fault

Recommendation

Use analog outputs to control auxiliary vacuum equipment such as heaters, actuators, ion sources and throttle controllers. Connect analog output signals to Programmable Logic Controllers to perform sophisticated process control.

Capacitance Manometers (CM1-CM4)

Basics

Capacitance manometers (CMs) are very accurate devices for measuring both absolute and differential pressures. They measure all gases and materials that are vapors at the gauge's operating temperature. Gauge heads are specified by their full scale range, Pmax (10,000 Torr - 0.1 Torr), and have a dynamic range of approximately 4 decades. The standard output is a dc analog voltage, independent of the gas, linear with pressure, and equal to 10 V at Pmax. Gauge volume is small, and response is fast. Capacitance manometers commonly offer accuracies of 0.25%, while high-accuracy products can offer 0.08%. Capacitance manometers are so accurate that gauge-head temperature variation is a critical source of error. The long-term accuracy of capacitance manometers (better than 1%) justifies their use as secondary standards and transfer gauges.

For critical applications where repeatability, precision, and composition independent readings are required, a capacitance manometer gauge should be used to monitor and control the process pressure! This is particularly true if complex or changing gas mixtures are involved.

Note

Capacitance manometers may be ordered from several commercial sources. Gauge heads can be purchased with two ports for differential measurements, or with an evacuated reference side for absolute pressure measurements.

Heated capacitance manometers, maintained at temperatures above ambient, are used extensively in chemical processes, gas handling systems, and semiconductor processing systems operating under two sets of conditions:

1. ambient temperature undergoes large fluctuations
2. system contains vapors that would otherwise condense on the sensor

Heated CMs are used in measuring pressures found in (1) chemical processes containing water vapor and organic materials that boil at modest temperatures, and (2) semiconductor manufacturing processes, particularly aluminum etching where AlCl_3 vapor exists.

When heated sensor heads are used, the temperature of the sensor usually is greater than that of the chamber whose pressure is to be measured. The pressure reading will be a few percent high under some conditions due to an effect known as thermal transpiration.

For More Information

For additional information on CMs and the thermal transpiration effect consult :

1. "Foundations of Vacuum Science and Technology", Ed. J. M. Lafferty, John Wiley and Sons, NY, 1998, p. 384.
2. R. W. Hyland and R. L. Shaffer, "Recommended Practices for the Calibration and Use of Capacitance Diaphragm gauges as transfer standards", J. Vac. Sci. Technol. A 9 (1991) 2843.

CM Connection

The standard PPM100 controller can display pressures measured from standard capacitance manometers (CMs). Up to four independent CM readings can be monitored simultaneously using the four Analog I/O ports. Pressure readings are updated at 2 Hz. The PPM100 precisely measures the 0 to 10 Vdc linear output signal from the CM to determine pressure. Direct pressure readings are accurate only if the full scale range (PMax) of the gauge is programmed, and CM Display is set to Linear in the controller. Full-scale ranges up to 1000 Torr are supported by the controller. Simultaneous display of voltage and pressure levels in the AnalogIO display provides a convenient way to check proper configuration of the CM measurements.

An 'OVERLOAD' message is displayed when the output signal from the CM exceeds 12 V.

For added convenience, the PPM100 also supplies an auxiliary ± 15 Vdc/100 mA power output. This power is usually sufficient to operate a pair of standard (i.e. non-heated) capacitance manometers.

For More Information

Chapter 1 includes all the basic information required to install and set up your PPM100 controller and its gauges, including capacitance manometers. Chapter 3 describes, in detail, all menus required to configure the IPPM100 to display pressure readings from capacitance manometer gauges.

Tips For Using CMs

1. Avoid overpressurizing the gauge head. Use pressure relief and isolation valves whenever required. Always vent pressure safely. If working with toxic gases, vent to a hood or approved outlet. Never vent toxic gas to the room air.
2. Maintain a stable temperature around non-heated gauges.
3. Allow long warm up times for heated gauge heads. Consult manufacturer's recommendations.
4. Avoid contamination and particulate buildup inside the gauge since that could affect diaphragm motion. Some gauge designs offer special features to avoid such buildup.
5. Avoid mechanical vibrations.
6. Eliminate any chances of mechanical stress to the gauges. Use bellows if necessary.
7. Recalibrate frequently. Rezero often.

Compact Gauges

Compact Gauges are becoming increasingly popular in vacuum applications and share some standard characteristics: (1) the measurement and control electronics are integrated into a small package (mounted directly on the gauge head), (2) a modest DC power supply is required to operate the gauge and its electronics, and (3) pressure data is directly read via an output voltage proportional to the pressure. In its most popular implementation, the voltage output is related to the log of the pressure and the typical scaling factor is 1V/decade of pressure (Torr).

Most compact gauges can be connected directly to the ANALOG I/O ports of the PPM100. The controller includes a logarithmic scaling mode for the CM pressure calculations which makes it possible to display compact gauge pressures directly on its front panel. A 1V/decade relationship between voltage output and pressure is the only requirement for compatibility. To implement this pressure display mode: (1) program Pmax to the pressure corresponding to a 10V gauge output signal, (2) set CM display=Log. The pressure readings are displayed in the CM Data box (or Data Bar) associated to the analog port connected to the gauge.

It is also common for Compact Gauges to bracket their useful pressure related output between 2 and 10Vdc. Voltages below 1V indicate a Gauge Off Condition and voltages greater than 10V indicate a Fault condition. These conditions are detected (by Default) by the PPM 100 when CM Display=Log is selected.

Consult the manufacturer's power requirements for the compact gauge. It is often possible to use the +/- 15Vdc auxiliary output provided by the PPM100 to power compact gauges as well as capacitance manometers.

Chapter 5

Process Control

This chapter provides the basic guidelines required to successfully interface and program the automation features built into the Process Control module of the PPM100 controller.

In This Chapter

Process Control Warnings	5-3	Digital I/O Module	5-17
Why Use Process Control?	5-4	TTL Input (8 pins)	5-17
Process Control Basics	5-5	TTL Output (8 pins)	5-17
ACTIVE vs INACTIVE	5-6	Remote Control Input (7 pins)	5-17
ACTIVE	5-6	Digital I/O Connections	5-18
INACTIVE	5-6	TTL I/O Pin Assignments	5-18
Power-On State	5-6	Output Circuit	5-20
Programming Rules	5-6	Connection Tips	5-21
Manual Override	5-7	Debounce Time	5-21
Fail-Safe Logic	5-8	Remote Control Inputs	5-22
Relay Connections	5-11	RGA_Degas	5-22
Connection Basics	5-12	RGA_FIL_Lockout	5-22
Connection Schemes	5-12	RGA_Key_Disable	5-23
Active-Common	5-12	Clear_Data_Log	5-23
Inactive-Common	5-13	RGA_Remote_Enable	5-24
Active-Common-Inactive	5-13	RGA_Fil_On	5-24
Connection Tips	5-14	RGA_FP_Disable	5-24
Channel Linking	5-15		
Remote Operation	5-16		

Process Control Warnings

- It is the user's responsibility to ensure that the automatic control signals provided by the process control module of the PPM100 are always used in a safe manner.
- Carefully check the programming of the system, and test every individual channel connection under MANUAL control, before switching to AUTO Mode operation.
- When an equipment failure or power shutdown condition could cause a hazardous situation, always provide fail-safe precautions. As an example, a pressure relief check valve should be used in conjunction with an automated backfill valve when the risk of dangerous overpressure is possible.
- Even if the control logic seems simple and obvious, we recommend that you always develop a logic diagram (flowchart) of the process control function you wish to implement.
- To minimize programming and connection errors, prepare a Specification Table which lists the rule parameters, measurement sources, and connection scheme for each channel.
- Keep a copy of the circuit schematic, which illustrates how each piece of equipment is connected to the process control module, in this manual.
- Carefully consider the response of your process control setup during and after power losses. A properly wired setup should protect the system and operators from hazardous conditions whenever power is lost, and should remain in a safe state after power is reestablished.
- Keep in mind that all process control channels are set to Manual Mode, INACTIVE, every time the PPM100 controller is powered up (this should be considered a Fail-safe state). You must switch the appropriate channels to Auto Mode to restart automated operation after every power up.
- No process control actions take place based on RGA readings while the spectrometer is establishing emission current, while the ionizer is degassing or while in the MassSpec Display (performing analog scans).
- To prevent relay arcing, use transient absorbers when connecting inductive loads, such as motors or solenoids, to the process relays. It may be necessary in some cases to use an external power relay driven by a process relay to switch a device on and off.
- No single-mass partial pressure readings are performed while the MassSpec display is active. As a consequence, all partial pressure related process control events are frozen while mass spectra are being displayed. Partial pressure readings and related process control resume when the MassSpec display is exited.
- All process channels must be set to a safe manual state, either Active or Inactive, prior to:
 - accessing the MassSpec Display
 - calibrating the RGA electrometer
 - degassing the RGA
 - changing the Silent/Audio Leak Trend mode in the Monitor Display

Why Use Process Control?

Fully automatic vacuum system operation is universally recognized as the most effective way to provide:

- Reproducible process conditions → increased productivity
- Fault protection → decreased down-time
- Unattended operation → more efficient use of operators' time
- Safe operation in the hands of inexperienced users → reduced chances of errors and accidents
- System automation for repetitive processes → automate repetitive events such as sample loadings and pump downs

One of the best ways to improve process yield and reduce system failure is through automation. Process automation is most important in complex systems or in systems operated by inexperienced personnel. The process control capabilities of the PPM100 make it unnecessary for the operator to be physically present to operate valves and/or actuate switches at the right time. In fact, a PPM100 with its embedded web server provides remote control capabilities from anywhere in the world.

The PPM100 Process Control Module is commonly used to,

- Automatically control vacuum components such as valves, heaters, power supplies, shutters and other process equipment.
- Interlock process control operations with external signals that are related to time, pressure, temperature, gauge status, system status, TTL logic levels and other parameters.
- Automatically control pumpdown, venting and load-lock procedures.
- Signal when a process is complete or alert operators to system conditions that require their attention.
- Link process control channels together to create powerful system logic to control a wide variety of functions.
- Automate repetitive operations.
- Use e-mail notification to warn operators about possible system problems over the internet.
- Control a system remotely through the computer or web interfaces.

Process Control Basics

A PPM100 box fitted with a Process Control Module, is a powerful and versatile vacuum system controller. The process control module provides eight independent channels for system automation. Each channel has a relay closure output, and associated opto-isolated TTL output logic signal, that may be linked to a variety of input sources through user-programmable rules.

When in AUTO mode, the state of a channel is linked to the readings from an input source. This input source can be:

- any partial/total pressure measurement or analog input
- the system clock
- a dedicated TTL input pin

Channel Rules define the exact conditions under which channels change state during automated operation. The parameters required to fully specify a rule include:

- input source
- setpoint (level, polarity and hysteresis)
- setpoint delay
- channel description and labels
- audio alerts

Process control programming is fast, straight-forward and designed for non-programmers. A complete listing of the Rule editing menus can be found in Chapter 3 of this manual, and will not be reproduced in this chapter.

During automated operation, the output status of all eight channels can be monitored in real time from the front panel (see Process Control Display in Chapter 3). Also, eight dedicated Process Control LEDs (located below the screen) and programmable audio alarms are available to announce process control events.

Manual Override is available for all channels. This allows channel relays and their TTL outputs to be operated directly from the front panel.

All process control events are automatically time stamped and recorded in the Process Control Log. Use the [History] QuickKey in the Process Control Display to review the log. Note that the log is erased when the power is turned off.

The Process Control module also includes 7 opto-isolated TTL inputs. These inputs can be used to remotely control various controller functions including:

- remote enable
- filament on/off
- degas on/off
- RGA Filament lockout
- RGA Keypad disable
- Data Log reset
- touchscreen disable

ACTIVE vs INACTIVE

The state of a process control channel is either ACTIVE or INACTIVE.

ACTIVE

When a process control channel is ACTIVE,

- its TTL output is logic low
- its relay is energized or on - the Common and Active (normally open, N.O.) pins are connected together
- its channel LED on the front panel is ON

INACTIVE

When a process control channel is INACTIVE,

- its TTL output is logic high
- its relay is de-energized or off - the Common and Inactive (normally closed, N.C.) pins are connected together
- its channel LED on the front panel is OFF

When a process control channel is in Auto mode, it becomes ACTIVE when the conditions specified by its rule's parameters are met.

Manual operation of the channel output is possible using Manual Override from the front panel or over a computer interface.

Power-On State

All process control channels are set to Manual Mode and INACTIVE, when the PPM100 is powered up. The user must switch the required channels back to Auto Mode to restart automated operation every time the unit is powered up.

Programming Rules

The process control board provides eight independent channels for system automation. Each channel has a relay closure output and associated opto-isolated TTL output signal.

The channel state may be controlled (1) manually (Manual Override below) or (2) automatically, by linking its state to an input source through user-programmable rules.

While in AUTO mode, the state of a channel can be linked to the readings from (1) any partial or total pressure measurement or analog input, (2) the system clock, (3) a dedicated TTL input pin or (4) an alarm notification.

Channel Rules define the exact conditions under which channel state activation or deactivation takes place during automated operation. The parameters required to fully specify a rule include (1) input signal (source), (2) activation setpoint (level, polarity and hysteresis), (3) delay and (4) audio alerts. For channels linked to partial/total pressure

measurements, the user must also specify a channel state for when the RGA/gauge is off or in a fault condition.

Process control programming is fast, straight-forward and designed for non-programmers. Rule editing menus do not require any prior programming experience, and present choices in a simple format.

The variety of signal sources available to every channel provides process control versatility that extends beyond what has been traditionally expected from vacuum gauge controllers. For example, one channel could open the main gate valve every time the PP1 readings from the main chamber drop below a user-specified level, while the next channel controls overnight bakeouts, by using the clock to power a heating envelope during off-hours.

For More Information

Consult Chapter 3 of this manual for a complete description of the Process Control menus, parameters and displays used to program, monitor and control the process control module. See Chapter 7 for information about controlling the process channels over a remote computer interface.

Manual Override

Manual Override is available for all channels, making it possible to manually operate channel relays and TTL outputs directly from the front panel.

Manual control of the channels is performed from the Process Control Display.

Use the [Process] or [Back to Process] QuickKey to bring up the Process Control Display screen. This display consists of eight Channel Data Boxes, each displaying state and configuration information for a process control channel.

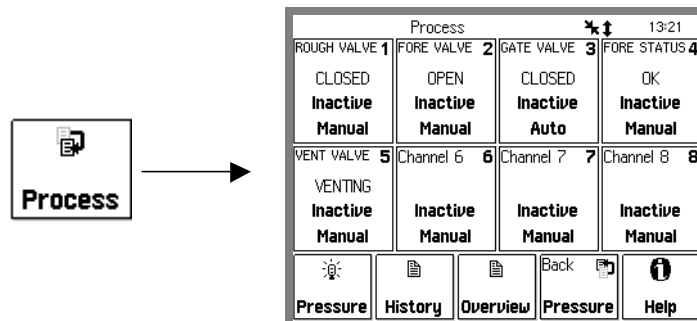

Figure 5-1. Process Control Display.

Touch a Channel Data Box to choose a channel state (Active, Inactive or Auto) or edit the channel rules and labels.

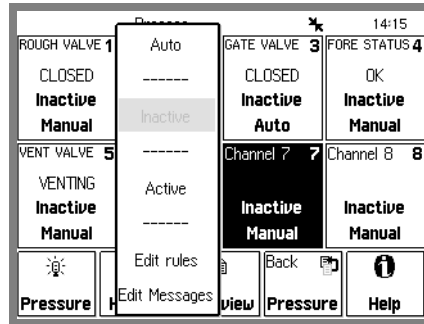

Figure 5-2. Channel Options.

Choose...

- 'Inactive' to manually DEACTIVATE the channel
- 'Active' to manually ACTIVATE the channel
- 'Auto' to switch the channel to Auto mode - its state is now controlled by the channel rules
- 'Edit Rules' to edit the channel rules
- 'Edit Labels' to edit the text and audio options for the channel

Recommendations

Always use Manual Operation to test your process control connections before switching to (and relying on) Automatic mode for channel operation.

Use Manual Override to quickly switch an automated procedure to manual control in an emergency.

Use Channel Labels to display real system names and states for each channel. This eliminates confusion over which channel is connected to which device.

All process control channels default to Manual Mode, INACTIVE, when the PPM100 controller is first turned on. *This must be regarded as the Fail Safe state of the system.*

For More Information

Consult the Process Control sections of Chapter 3, including descriptions of the Process Control Display, Channel Data Boxes and Rules Editing menus.

Fail-Safe Logic

WARNING!

When equipment malfunction or power loss could cause a hazardous situation, always provide fail-safe operation.

Fail-Safe logic must be very carefully planned, designed and tested before reliance on process automation is allowed.

PPM100 users must carefully consider the behavior of their process control setup during, and after,

- system failures
- equipment malfunctions
- operator errors
- power losses

Typical "unsafe" situations that must be anticipated and accounted for in logic designs, include,

- Gauges and RGAs, used as input sources for process control channels, can turn off in the middle of a process due to overpressure, electronics failure or operator error.
- Input Analog I/O ports, used as channel sources, can overload or be mistakenly switched into outputs in the middle of a process.
- Complete power loss can result in total system shutdown.

A properly designed process control setup must respond to all of the above conditions by immediately shifting the system into a fail-safe state.

A carefully wired and programmed fail-safe state should be available to protect the equipment and operators from danger under any one of the potentially dangerous events described above.

Fail-Safe logic must be very carefully planned, designed and tested before reliance on process automation is allowed.

The following guidelines MUST be considered during fail-safe logic design,

- Channels linked to gauge readings include the "Gauge-Off/DAC State" rule. *This must be specified* to provide the proper fail-safe response in case the RGA or gauge shuts down and no pressure readings are available to the channel.
- Channels linked to analog input readings (AN1-4 and CM1-4) also include the "Gauge Off/DAC State" rule. *This must be specified* to provide the proper fail-safe response in case the analog port is mistakenly switched into an output and no voltage or capacitance manometer readings are available to that channel. This rule also applies when the analog input is in overload.
- During a power shutdown all relays are de-energized and in the INACTIVE state - Common and Inactive pins connected. *This must be carefully considered* during the design and implementation of your process control setup, to assure proper fail-safe operation during power loss and after power recovery.
- The PPM100 controller *does not automatically turn back on* once power is re-established after power loss. Instead, the user must turn the unit back on manually. During this time, all relays are de-energized and in the INACTIVE state (fail-safe state).
- *When the PPM100 is turned on, all channels are set to Manual Mode and INACTIVE. This is considered the fail-safe operating mode.* The user must

5-10 Process Control

set the required process control channels back to Auto to restart automated process control every time the PPM100 controller is turned on.

Relay Connections

Each process control channel has an associated relay. The relay specifications are:

Configuration	SPDT (Single Pole, Double Throw)
Contact Rating	5 A, 250 VAC/30 VDC, resistive load only
Contact Material	AgSnOInO

Use the two 12-Position Terminal Block Plugs located on the back panel to connect to the eight process control relays. Relay pins are labeled I (Inactive), C (Common) and A (Active) for easy association to channel states.

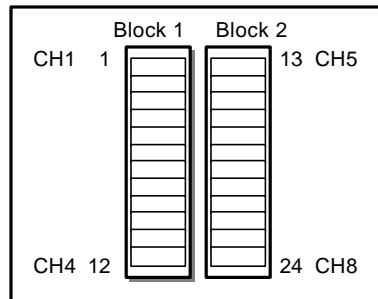

Figure 5-3. The 2 12-position terminal blocks for process relay connections.

Block	Pin	Process Channel	Process Control Label	Relay Pin	
1	1	1	Common (C)	C	
	2		Inactive (I)	N.C.	
	3		Active (A)	N.O.	
	4	4	2	Common (C)	C
		5		Inactive (I)	N.C.
		6		Active (A)	N.O.
	7	7	3	Common (C)	C
		8		Inactive (I)	N.C.
		9		Active (A)	N.O.
	10	10	4	Common (C)	C
		11		Inactive (I)	N.C.
		12		Active (A)	N.O.
2	13	5	Common (C)	C	
	14		Inactive (I)	N.C.	
	15		Active (A)	N.O.	
	16	16	6	Common (C)	C
		17		Inactive (I)	N.C.
		18		Active (A)	N.O.
	19	19	7	Common (C)	C
		20		Inactive (I)	N.C.
		21		Active (A)	N.O.
	22	22	8	Common (C)	C
		23		Inactive (I)	N.C.
		24		Active (A)	N.O.

Note: Block #2 must be removed in order to be able to access its side screws.

Connection Basics

When a process control channel is ACTIVE its relay is energized, or on, connecting the Common and Active (N.O.) pins. Active Pins are labeled 'A' on the back panel, and correspond to the Normally Open pin of the SPDT relay.

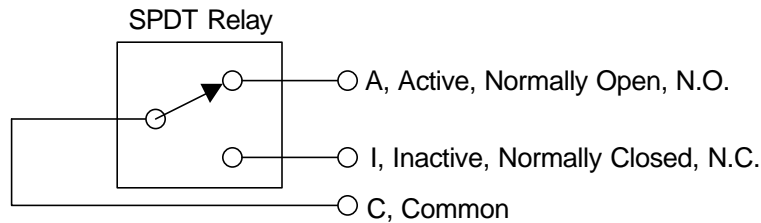

Figure 5-4. Active relay connection.

When a process control channel is INACTIVE its relay is de-energized, or off, connecting the Common and Inactive pins. Inactive Pins are labeled 'I' on the back panel, and correspond to the Normally Closed pin of the SPDT relay.

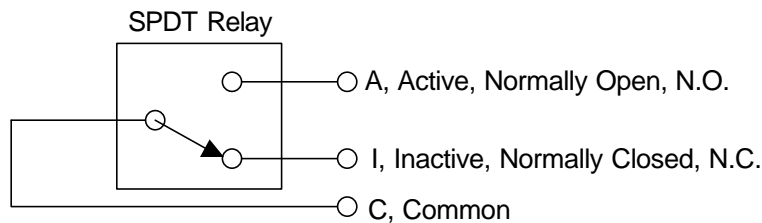

Figure 5-5. Inactive relay connection.

Connection Schemes

Process control relays have three pins and three connection schemes are possible.

Active-Common

The relay is wired as a single throw switch, with connections to the Active and Common pins only. Contact closure takes place during the ACTIVE state of the channel. Contact is open during the INACTIVE state of the channel and during power shutdowns. For example, use this connection to turn a heater on and off, using the relay as a power switch. Heat is available only when the channel state is ACTIVE.

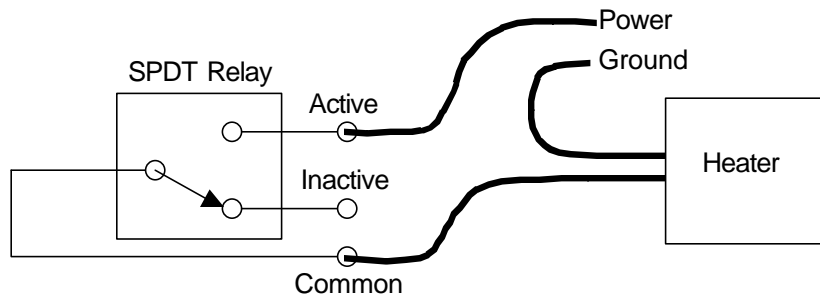

Figure 5-6. Using a relay as a power switch. (Shown in Inactive state.)

In this case, the Active and Common connections may be swapped. Connecting as shown prevents power from appearing on the Inactive pin when the channel is Inactive.

Inactive-Common

The relay is also wired as a single throw switch, but with connections to the Inactive and Common pins. Contact closure takes place during the INACTIVE state of the channel. Contact between the pins is also established during power shutdowns (fail-safe state). For example, use this connection scheme to turn an auxiliary power supply on after a main power failure. As the main power shuts down, the relay is deactivated, delivering backup power to the experiment. In general, use this connection scheme whenever you need a contact to open during the active state of the channel.

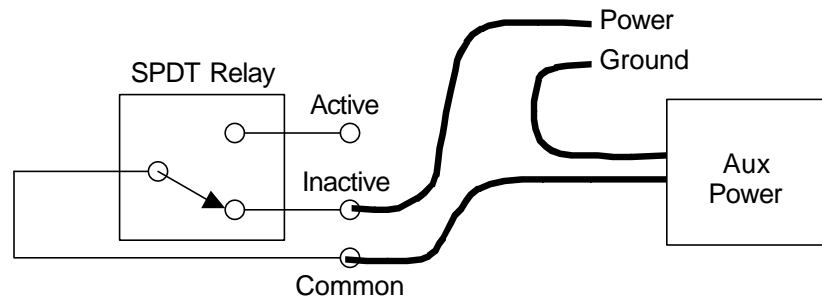

Figure 5-7. Using a relay as a back-up power switch. (Shown in Inactive, power-off state.)

In this case, the Inactive and Common connections may be swapped. Connecting as shown prevents power from appearing on the Active pin when the channel is Active.

Active-Common-Inactive

The relay is used as a true double throw switch, with connections to its three pins. As an example, consider a system where an electrical power source is shared between two instruments (#1 and #2), but only one instrument is powered at a time (sequential operation). In this scheme, the supply wire is connected to the Common pin and the Active and Inactive pins are connected to the power input pins of instruments #1 and #2, respectively. Switching the channel state between ACTIVE and INACTIVE redirects the power from instrument #1 to instrument #2.

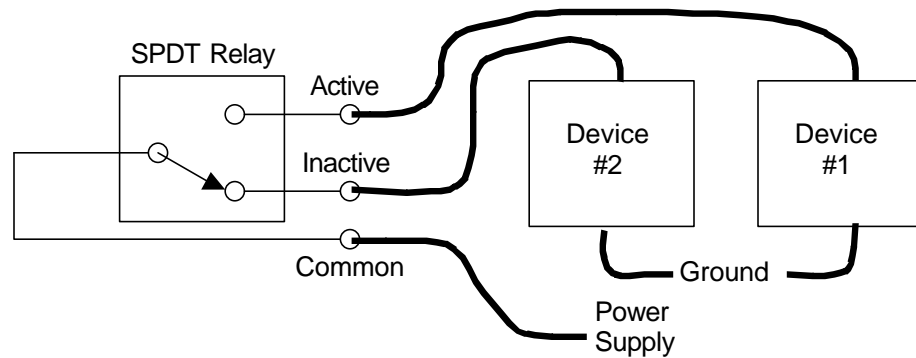

Figure 5-8. Using a relay as a power multiplexer. (Shown in Inactive, power-off state.)

A similar scheme could be used to monitor (sequentially) two separate sensors from a single-input reader (signal multiplexing). In this case, the reader's input is connected to Common, and sensors 1 and 2 connect to pins A and I of the relay, respectively. Activate the channel to monitor sensor 1, or deactivate the channel to switch to sensor 2.

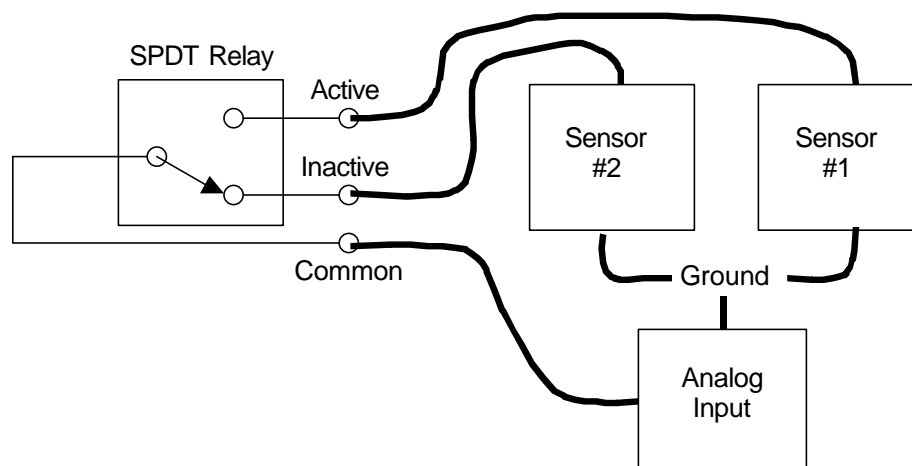

Figure 5-9. Using a relay as a signal multiplexer. (Shown in Inactive, power-off state.)

Connection Tips

- Both Terminal Block Plugs can be disconnected from the back panel, making it possible to transfer the controller to a different location without having to undo the relay connections. Spare Terminal Blocks are also available from Stanford Research Systems for lab environments where more than one wire connection scheme is required.
- Make sure all wire ends are securely fastened to the Terminal Block Plugs, always tighten the wire-lock screws.
- Block #2 (Relays 5-8) must be disconnected from the process control board in order to be able to access its side wire-lock screws. Gently pry the block out with a small screwdriver using the access slots in the panel above and below the connector.
- Relays are used in vacuum systems for many different purposes:
 - Power distribution/switching to system components such as gate valve actuators, heating jackets, etc.
 - Interlocking. Many pump controllers include relay closure detection ports designed for interlocking purposes.
 - Signal multiplexing. For example, it is not unusual to multiplex a single input temperature reader between two temperature sensors.
 - Sound alarms on/off.
 - Start/stop processes
- In order to prevent costly mistakes, label every cable connected to the process control relays with an unambiguous name. Include the pin#, pin label, and channel# in case the cable comes loose and needs to be reattached to the controller.

- Do not exceed the relay ratings: 5 A/250 VAC/30 VDC, resistive load, during operation.
- Use transient absorbers when connecting inductive loads, such as motors or solenoids, to the process relays. It may be necessary in some cases to use an external power relay driven by a process relay to switch a device on and off.
- Ensure that all process control channels are under manual control, and in the desired state, prior to connecting a wired terminal block plug into the process control board's receptacle.
- During a power shutdown, all relays are de-energized and switch to their INACTIVE state - i.e. Common and Inactive pins connected. This must be carefully considered during the design of your process control setup, to assure proper fail-safe operation during and after power losses.

Channel Linking

Process control relays can be linked together to create powerful system logic and control complicated functions. As an example, consider the implementation of an overnight bakeout system with over-temperature protection. Since heating jackets have been known to runaway and cause serious system damage, it is always a good precaution to add a safeguard system that will shut down the heating power if the temperature generated by the heater exceeds the maximum allowed threshold. This is easily implemented with the PPM100 if a thermocouple is attached to the vacuum system and its amplified voltage signal is monitored through one of the Analog I/O ports of the controller. A straightforward implementation of this function might be: (1) link channel 1 to the clock and program its activation period throughout the middle of the night, (2) link channel 2 to the AN1 thermocouple readings and program it to activate at voltage readings below the maximum allowed temperature value, (3) connect the channel 1 and channel 2 relays in series, using the Active-Common connection described above, and use the dual-switch combination as a power switch for the heater's power cord. Under this configuration, heating is only possible if channel 1 AND Channel 2 are both simultaneously Active. If the temperature exceeds the maximum specified value (channel 2 deactivated), or the bakeout time expires (channel 1 deactivated), no electrical power can flow into the heating jacket and the bakeout is interrupted.

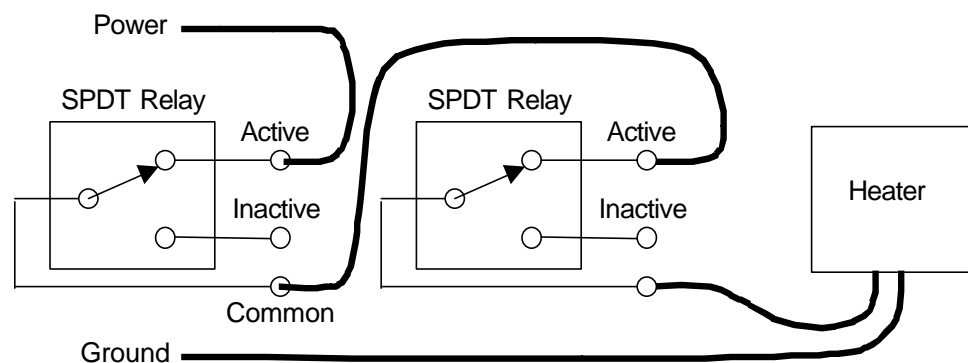

Figure 5-10. Using two relays in series to provide an interlock function.
(Both relays shown in Active state.)

Remote Operation

Channel relays can be operated remotely through the computer (RS-232, GPIB or USB) and web interfaces. Use this convenient feature to control experiments or processes from anywhere in the world. For example, turn off your bakeout jackets from home before leaving for work, so that the system can cool down during your commute and is ready to start an experiment as you get into the lab.

Function : MONITOR

Last Reading : 15jul03 at 13:31

Gauges

Gauge	Reading	Name
PP1	1.68-07 Torr	Hydrogen
PP2	5.31-09 Torr	Helium
PP3	2.71-07 Torr	Water
PP4	2.44-06 Torr	Nitrogen
PP5	4.87-07 Torr	Oxygen
PP6	4.05-08 Torr	Argon
PP7	8.10-09 Torr	Pump oil
PP8	1.21-07 Torr	CO2
AN1	+6.822 V	FLOW CONTROLLER
AN2	+5.319 V	PULSED VALVE
AN3	-0.212 V	HEATING JACKET
AN4	+7.984 V	THROTTLING VALVE

Relay Status

Channel	1	2	3	4
Description	GATE VALVE	HEAT JACKET	TURBO PWR	WATER LINES
Current State	INACTIVE	INACTIVE	INACTIVE	INACTIVE
	MANUAL	MANUAL	MANUAL	MANUAL

Channel	5	6	7	8
Description	DETECTOR	DIFF PUMP PWR	PULSED VALVE	MECH PUMPS
Current State	INACTIVE	INACTIVE	INACTIVE	INACTIVE
	MANUAL	MANUAL	MANUAL	MANUAL

Running on a Nexm Web Controller

Figure 5-11. PPM100 web page showing relay status and control via the internet.

Digital I/O Module

The DIGITAL I/O module included with the Process Control board supports three types of logic signals. The TTL signals are opto-isolated from the PPM100 chassis. The inputs may be electrically floated as a group. The outputs may be electrically floated as a group, separate from the inputs.

TTL Input (8 pins)

Each process control channel has a dedicated TTL input pin. While in AUTO mode, channel control can be linked to this TTL input. The logic level (TTL HIGH or LOW) responsible for channel activation must be specified by the user (factory default setting is active low, meaning that the channel is ACTIVE when the logic level on the pin is LOW.)

TTL Output (8 pins)

Each process control channel has a dedicated TTL output signal. Following common industry standards, all process control TTL output signals are Active Low - when a process control channel is ACTIVE, the corresponding TTL output is logic LOW. INACTIVE means the channel's TTL output pin is logic high.

Remote Control Input (7 pins)

The Process Control module also includes 7 TTL logic inputs for remote logic control of various controller functions.

- RGA remote enable
- RGA Filament On/Off
- Degas On/Off
- RGA Filament lockout
- RGA keypad disable
- Data log clear/reset
- Front Panel disable

Recommendation

Use the Remote Control TTL inputs to control important PPM100 functions remotely, without the need for a computer interface. A common application is clearing the data logging buffer to synchronize the start of the data log with a particular event, such as (1) the opening of a gate valve or (2) the achievement of full speed by a turbo pump. Gate valve and turbo pump controllers often provide logic outputs compatible with the remote control module. Remote control inputs can also be interfaced with Programmable Logic Controllers' signals.

Digital I/O Connections

Use the female DB37 port located on the back panel of the PPM100 controller (labeled DIGITAL I/O) to connect to the (1) eight PC TTL Output, (2) eight PC TTL input, and (3) 7 Remote Control TTL input pins of the Process Control Board.

Note

A Male DB37 connector is included with every PPM100 controller shipped directly from Stanford Research Systems to facilitate interfacing of the TTL I/O port to your system.

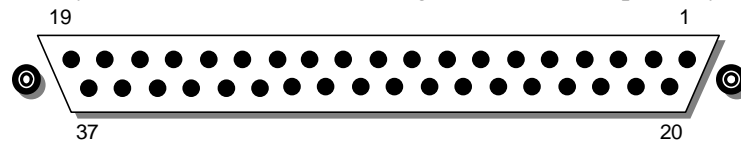

Figure 5-12. DB37 TTL I/O connector.

TTL I/O Pin Assignments

Unconnected inputs are HIGH.

Module	Pin	Name	Description
	1	PPM100 Vcc	+5 V OUT
Remote Control TTL IN	2	ANODE COM	External User +5 V IN
	3	Not Used	
	4	Not Used	
	5	RGA_Degas	Edge trigger: ↓= Degas On, ↑=Degas Off
	6	RGA_FIL_Lockout	Level: LOW=RGA emission Off
	7	RGA_Key_Disable	Level: LOW=Disable front panel Keypad.
	8	Not Used	
	9	Not Used	
	10	Clear_Data_Log	Edge trigger: ↓=clear the data log
	11	RGA_Remote_Enable	Level: HIGH=Ignore RGA_Degas_On, RGA_FIL_On, RGA_EMULT_On pins.
	12	RGA_FIL_On	Edge trigger: ↓=FIL ON, ↑=FIL Off
	13	Not Used	
	14	RGA_FP_Disable	Level: LOW=Disable Touchscreen and Keypad
		15	PPM100 Vcc
Process Control TTL OUT	16	TTL_OUT_5	TTL OUT for Channel 5. LOW=ACTIVE
	17	TTL_OUT_6	TTL OUT for Channel 6. LOW=ACTIVE
	18	TTL_OUT_7	TTL OUT for Channel 7. LOW=ACTIVE
	19	TTL_OUT_8	TTL OUT for Channel 8. LOW=ACTIVE

Module	Pin	Name	Description
Process Control TTL IN	20	ANODE COM	External User +5 V IN
	21	TTL_IN_1	TTL Input Signal for Channel 1. Active LOW
	22	TTL_IN_2	TTL Input Signal for Channel 2. Active LOW
	23	TTL_IN_3	TTL Input Signal for Channel 3. Active LOW
	24	TTL_IN_4	TTL Input Signal for Channel 4. Active LOW
	25	TTL_IN_5	TTL Input Signal for Channel 5. Active LOW
	26	TTL_IN_6	TTL Input Signal for Channel 6. Active LOW
	27	TTL_IN_7	TTL Input Signal for Channel 7. Active LOW
	28	TTL_IN_8	TTL Input Signal for Channel 8. Active LOW
	29	unused	
	30	PPM100 Ground	
	31	PPM100 Ground	
Process Control TTL OUT	32	COM_EMTR_REF	External User Ground
	33	COM_COLTR_PULLUP	External User +5 V IN
	34	TTL_OUT_1	TTL OUT for Channel 1. LOW=ACTIVE
	35	TTL_OUT_2	TTL OUT for Channel 2. LOW=ACTIVE
	36	TTL_OUT_3	TTL OUT for Channel 3. LOW=ACTIVE
	37	TTL_OUT_4	TTL OUT for Channel 4. LOW=ACTIVE

Note: ↓=HIGH-to-LOW, ↑=LOW-to-HIGH transition.

Input Circuit

The TTL inputs are opto-isolated from the PPM100. The schematic of a TTL input is shown below.

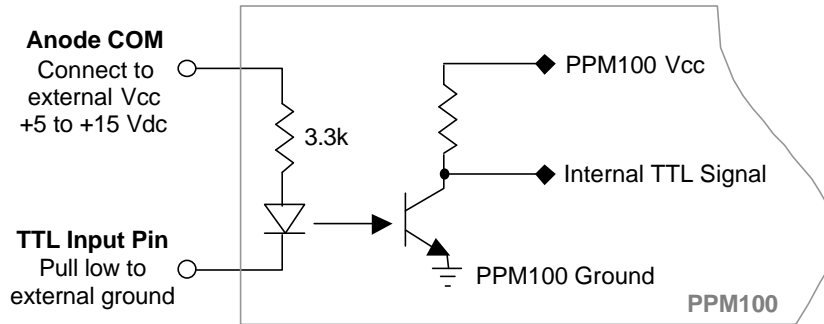

Figure 5-13. TTL input pin schematic.

For isolated operation of ALL TTL inputs, connect ANODE_COM (pins 2 and 20) to the external Vcc supply (+5 to +15 Vdc). Pull inputs to external ground for low inputs.

For non-isolated operation of ALL TTL inputs, connect ANODE_COM (pins 2 and 20) to PPM100 Vcc (pin 1 or 15) and pull inputs to PPM100 Ground (pin 30 or 31) for low inputs.

In both cases, leaving an input unconnected or open is equivalent to a HIGH input.

Output Circuit

The TTL outputs are opto-isolated from the PPM100. The schematic of a TTL output is shown below.

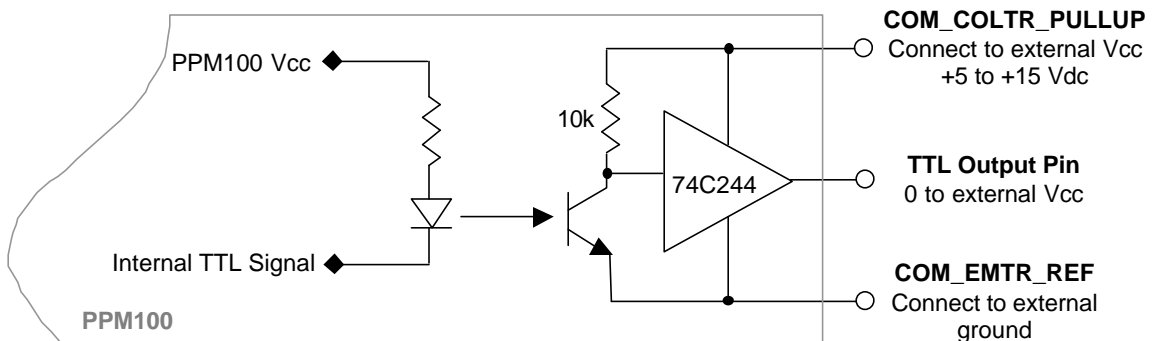

Figure 5-14. TTL output pin schematic.

For isolated operation of ALL TTL outputs, connect COM_COLTR_PULLUP (pin 33) to the external Vcc supply (+5 to +15 Vdc) and COM_EMTR_REF (pin 32) to the external ground. The TTL output will be external 0 V or Vcc (low or high).

For non-isolated operation of ALL TTL outputs, connect COM_COLTR_PULLUP (pin 33) to PPM100 Vcc (pin 1 or 15) and COM_EMTR_REF (pin 32) to PPM100 Ground (pin 30 or 31). The TTL output will be external 0 V or 5 V (low or high).

Connection Tips

- All TTL inputs may be connected to respond to relay closure signals, such as those provided by the mechanical position indicators of gate valves, or full speed indicators of turbomolecular pump controllers.
- Input and output pins can be linked together to create powerful system logic and control a wide variety of system functions. For example, Process Control TTL outputs can be connected to Remote Control TTL inputs and used to control functions such as powering gauges on/off or clearing the Data Log.
- The use of external TTL logic circuitry to provide additional logic manipulation of the TTL I/O signals complements the process control capabilities of PPM100. For example, connect the TTL I/O pins to an external PLC (programmable logic controller) or a home-built logic circuit to extend the capabilities of the process control ports.
- Use the TTL output signals to operate external relays, with ratings exceeding those of the built-in relays.
- Use the TTL outputs to indicate the status of the individual process control channels to external devices such as computers, logic analyzers and PLCs.

Debounce Time

A 50 ms debounce time is standard for ALL TTL inputs (Process Control and Remote Control). This prevents spurious glitches on the TTL lines from triggering process control events or controller functions.

For a level-triggered input, the debounce time is the minimum amount of time the input signal must remain unchanged, at the new logic level, before that level is recognized by the PPM100 and triggers a process control event or controller function.

For an edge-triggered Remote Control input, the debounce time is the length of time during which the input signal must remain unchanged following a level transition, before the edge is validated by the PPM100 and triggers a controller function.

Remote Control Inputs

RGA_Degas

Pin: 5
Trigger mode: Edge, ↓= ON, ↑=OFF
Debounce time: 50 ms

Prerequisites:

- RGA filament is turned on
- RGA_Remote_Enable is logic LOW
- RGA_Fil_Lockout is logic HIGH

Pulling the RGA_Degas control line LOW, after it has been high for at least 50 ms, and holding the line LOW for at least 50 ms, starts the degassing process on the RGA's ionizer. The input must remain LOW for the duration of the degas process. Degassing takes place for a period of 3 minutes (default degas time).

Degas can be terminated before the Degas Time has elapsed through the remote input by

- Switching the RGA_Degas input HIGH after it has been LOW for at least 50 ms
- Turning the RGA filament off
- Pulling the RGA_FIL_Lockout pin LOW.

RGA_FIL_Lockout

Pin: 6
Trigger mode: Level. LOW = RGA Filament locked off, HIGH = Normal RGA filament operation.
Debounce time: 50 ms

Prerequisites:

- RGA_Remote_Enable is logic LOW

HIGH allows normal RGA operation (unconnected default).

LOW forces the RGA Filament to turn off, and stay off - any request to turn the RGA Filament on is denied as long as the RGA_FIL_Lockout line remains LOW. This applies to requests from the front panel keys, the computer interfaces and the web server.

Recommendation

RGA_FIL_Lockout is one of the most useful remote control lines and is often used to interlock RGA Filament emission. For example, the RGA_FIL_Lockout line is often connected to the logic output of the mechanical position indicator of a load lock's vent valve. If the vent valve is opened (indicating that high pressure is present in the load lock chamber), the RGA Filament shuts down, and any attempt to turn it back on is denied, effectively protecting its filament.

RGA_Key_Disable

Pin: 7
Trigger mode: Level, LOW = Disable front panel RGA Keypad (i.e. black buttons).
Debounce time: 50 ms

Prerequisites:

- None

HIGH allows full manual control of the RGA from the front panel RGA Keypad (FILAMENT and EMULT black buttons).

If unconnected, this pin will be HIGH and the RGA Keypad is fully operational (default).

LOW locks out some of the RGA Keypad functionality: the FILAMENT and E. MULTIPLIER keys cannot be used to turn the filament or electron multiplier on as long as this line remains LOW. Turning off is unaffected.

The Power (red) button is unaffected by this pin.

Recommendation

Use this pin to protect the filament or electron multiplier during a process.

Clear_Data_Log

Pin: 10
Trigger mode: Edge, ↓ = Clear the data log.
Debounce time: 50 ms.

Pulling the Clear_Data_Log control line LOW after it has been high for at least 50 ms, and holding the line LOW for at least 50 ms, clears and resets the data log.

Recommendation

Use this input to synchronize the start of data logging with an important event such as a gate valve closing, a turbo pump achieving full rotational speed or a heating cycle getting started. For example, connect the Clear_Data_Log line to the logic output of your gate valve's mechanical position indicator to restart the data log buffer every time the gate valve is opened. This is useful for the collection of pump down curves. Connect the Clear_Data_Log line to a logic signal from your temperature controller indicating the start of a heating ramp, to monitor the entire temperature profile of a TPD experiment.

RGA_Remote_Enable

Pin: 11
Trigger mode: Level. HIGH = ignore RGA_Degas, RGA_FIL_On, and RGA_FIL_Lockout pins.

Debounce time: 50 ms

Prerequisites:

- None

The RGA_Remote_Enable line must be LOW for the PPM100 Remote Control Module to acknowledge the edge triggers from the RGA_Degas and RGA_FIL_On and the level of the RGA_FIL_Lockout pins.

If unconnected, this pin will be HIGH and remote control is disabled (default).

Recommendation

This pin is often used to enable/disable Remote Control of RGA functions. For example, it might be useful to lock the remote control signals during an electrically noisy process to prevent logic glitches from accidentally affecting RGA operation.

RGA_Fil_On

Pins: 12
Trigger mode: Edge, ↓= ON, ↑=OFF
Debounce time: 50 ms

Prerequisites:

- RGA_Remote_Enable is logic LOW
- RGA_FIL_Lockout is logic HIGH

Pulling the RGA_Fil_On control line LOW after it has been high for at least 50 ms, and holding the line LOW for at least 50 ms, activates filament emission in the RGA Ionizer. The input must remain LOW until it is required to turn the filament off.

RGA_FP_Disable

Pins: 14
Trigger mode: Level, LOW = Disable front panel touch screen LCD and keys.
Debounce time: 50 ms

HIGH allows normal operation of the front panel touch screen display and keys (unconnected default).

LOW locks the front panel touch screen LCD and keys. The front panel **(including the Power Button)** does not respond to touches.

Recommendation

The RGA_FP_Disable signal is often used to lock the front panel and block unauthorized changes to the controller during a process or experiment

Chapter 6

Remote Programming

In This Chapter

Index of Commands	6-3	Status Reporting	6-49
Alphabetical List of Commands	6-7	Status Registers	6-49
Introduction	6-11	Status Enable Registers	6-49
Communicating With RS-232	6-11	Serial Poll Status Register	6-49
Communicating With GPIB	6-11	*STB? to Read the Status	6-50
Communicating with USB	6-11	Serial Poll to Read the Status	6-50
Screen Indicators And Queues	6-12	Service Request	6-50
Command Format	6-12	Power-On Status	6-51
Command Synchronization	6-13	Status Reporting Commands	6-52
RGA Commands	6-14	Using USB	6-58
PPM100 to RGA Communication	6-14	Introduction	6-58
RGA Pass Through Mode	6-14	Windows 2000, XP, and 98	6-58
Command Syntax	6-15	Installing VCP (Virtual Com Port [without PNP support])	6-58
Pressure Units	6-15	Testing	6-59
Partial Pressure and Analog Input Measurement Commands	6-17	VCP Options : COM port number	6-59
PPM Monitor Setup Commands	6-21	Mac OS8 and OS9	6-60
Analog I/O Setup Commands	6-24	Installing USBSerial extension	6-60
RGA Commands	6-25		
Logging Commands	6-30		
Charting Commands	6-33		
Mass Spectrum Display Commands	6-35		
Process Control Commands	6-38		
Backlight Commands	6-44		
System Commands	6-45		
Interface Commands	6-47		

Index of Commands

Important

Always use the GPMU command at the start of a program to ensure that the desired units are in effect.

Use VERB 0 to set the RS-232 interface to terse mode for computer programs. Use VERB 1 to use verbose mode for console communications.

Variables

i, j, d, n, p	integers
x	real number
s, t	text strings

Partial Pressure and Analog Input Measurement

GPMU (?) {n} {s}	6-17	Pressure Units
GPBA (?) n {, p}	6-17	Data Bar Assign
GPDF (?) n {, i}	6-17	Display Format
GDAT ? p	6-18	Read Source Data
GDTX ? p	6-18	Read Source Data With Units
LRAT ? p	6-18	Read Leak Rate
LRCE (?) {n}	6-18	Leak Rate Coefficient
GDES (?) p {, s}	6-18	Gas Name/Port Location
GSTA ? p	6-19	Source Status
GSTT ? p	6-20	Source Status Time
OAQU ?	6-20	Read Monitor Alarm Status

PPM Monitor Setup

PCME (?) p {, i}	6-21	PPM Measurement Enable
MAME (?) p {, n}	6-21	PPM Mass
GDES (?) p {, s}	6-21	Gas Name/Port Location
SMCF (?) p {, x}	6-21	Gas Correction Factor
SVGL (?) p {, i}	6-22	Set Gas via Library
NFTM (?) p {, n}	6-22	PPM Scan Rate
HVTM (?) p {, i}	6-22	PPM Detector
OAEN (?) p {, i}	6-22	PPM Alarm Enable
OALH (?) p {, x}	6-22	Alarm Level High
OALL (?) p {, x}	6-23	Alarm Level Low
OABP (?) p {, i}	6-23	Alarm Beep

Analog Port Setup

GADM (?) n {, i}	6-24	I/O Mode
GDAS (?) n {, i}	6-24	DAC Source
GCMM (?) n {, i}	6-24	CM Mode
GDAV (?) n {, x}	6-24	Output Value
CMPX (?) n {, x}	6-24	CM PMax

RGA

MAXM ?	6-25	Read RGA Mass Range
RGAI ?	6-25	Read RGA Identification
EEEE (?) {n}	6-25	Electron Energy
IEEV (?) {i}	6-25	Ion Energy
FOPV (?) {n}	6-25	Focus Voltage
SCRA (?) {n}	6-26	Scan Rate

6-4 Index of Commands

ECMA (?) {x}	6-26	Electron Current
CALL ?	6-29	Calibrate RGA Detectors
CEIV ?	6-29	Calibrate RGA Electrometer
DGAS (?) {i}	6-25	RGA Degas On/Off
EMIS (?) {i}	6-26	RGA Filament Emission On/Off
ENEM (?) {i}	6-26	RGA Scan Electron Multiplier On/Off
EMBV (?) {n}	6-26	RGA Electron Multiplier Bias Voltage
EREQ (?) {i}	6-26	RGA Ionization Source
IRFE (?) {i}	6-27	RF7 Error Handling
LRER (?) {0}	6-27	Last RGA Error
PASS (?) {i}	6-28	RGA Pass Through
SYNC?	6-28	RGA SYNC

Logging

PLDS (?) {i}	6-30	Chart/Table Display
PLCL	6-30	Clear Data Log
PLGF ?	6-30	Read Data Log First
PLGN ?	6-30	Read Data Log Next
PLIN (?) {n}	6-31	Logging Interval
PLWT (?) {n}	6-32	Log Length
PLEN (?) {i}	6-32	Logging Enable
PLDD (?) {i}	6-32	Display Date
PLTR (?) {i}	6-32	TTL Reset Enable

Charting

LCPN (?) {x}	6-33	Chart/MassSpec Pmin
LCPX (?) {x}	6-33	Chart/MassSpec Pmax
LCVN (?) {x}	6-33	Vmin
LCVX (?) {x}	6-33	Vmax
LCSA	6-33	Autoscale Y-Axis
LCRG (?) {n}	6-33	Time Range
LCSF	6-34	Scale X-Axis to Full

Mass Spectrum Display

SCOK ?	6-35	Analog Scan OK
MENU d	6-35	Display Screen
SCMF (?) {n}	6-35	MassSpec Final Mass
SCMI (?) {n}	6-35	MassSpec Initial Mass
SCAN (?) {i}	6-36	Start/Stop Analog Scan
OSCC ?	6-36	MassSpec Complete
LCPN (?) {x}	6-36	Chart/MassSpec Pmin
LCPX (?) {x}	6-36	Chart/MassSpec Pmax
SYSA	6-36	Autoscale MassSpec Y-Axis
CTOM (?) {n}	6-36	Move MassSpec Cursor
MACB ?	6-37	Read MassSpec Mass
PACB ?	6-37	Read MassSpec Peak

Process Control

RDES (?) d {, s}	6-38	Channel Description
RLCL (?) d {, s}	6-38	Channel Active Message
RLOP (?) d {, s}	6-38	Channel Inactive Message
RBEP (?) d {, i}	6-38	Channel Beep
RMOD (?) d {, i}	6-38	Channel Mode
RSTA (?) d {, i}	6-39	Channel State
RAMS (?) d {, i}	6-39	Channel Input

RGOS (?) d {, i}	6-39	Gauge Off State
RTRP (?) d {, x}	6-39	Pressure Setpoint
RTRV (?) d {, x}	6-40	Voltage Setpoint
RPHY (?) d {, n}	6-40	Percent Hysteresis
RVHY (?) d {, x}	6-40	Voltage Hysteresis
RPOL (?) d {, i}	6-40	Setpoint Activation
RDEL (?) d {, n}	6-40	Setpoint Delay
RTCL (?) d {,n} {,s}	6-41	Activation Time
RTOP (?) d {,n} {,s}	6-41	Deactivation Time
RTIL (?) d {, i}	6-41	TTL Activation Level
TLL ?	6-42	Read TTL Inputs
RHGF ?	6-42	Read Process Log First
RHGN ?	6-42	Read Process Log Next
RHCL	6-43	Clear Process Log
RBAD ?	6-43	Relay Failure Status

Backlight		
BLN (?) {i}	6-44	Backlight Saver Enable
BLIT (?) {i}	6-44	Backlight On/Off
BLOF (?) {n} {s}	6-44	Backlight Turn-Off Time
BLON (?) {n} {s}	6-44	Backlight Turn-On Time
BLTD (?) {n}	6-44	Backlight Delay

System		
NAME (?) {s}	6-45	System Name
TIME (?) {s}	6-45	Time
DATE (?) {s}	6-45	Date
VOLC (?) {n}	6-45	Volume
MENU d	6-45	Display Screen
MESG (?) {s}	6-45	Message
DHWR ? d	6-46	Detect Hardware
*TST ?	6-46	Self-Test
FREV ?	6-46	Firmware Revision
VRDT ?	6-46	Firmware Build
SNUM?	6-46	Serial Number

Interface		
VERB (?) {i}	6-47	Verbose RS-232
*IDN ?	6-47	Identification
*RST	6-47	Reset
WSEN (?) {i}	6-47	Web Server Enable

Status		
*CLS	6-52	Clear Status
*PSC (?) {i}	6-52	Power-On Status Clear
*STB ? {i}	6-52	Read Serial Poll Status
*SRE (?) {i} {, j}	6-53	Serial Poll Enable
*ESR ? {i}	6-53	Read Standard Event Status
*ESE (?) {i} {, j}	6-54	Standard Event Enable
ERSW ? {i}	6-54	Read Error Status
ERSE (?) {i} {, j}	6-55	Error Status Enable
GSSW ? {i}	6-55	Read Gauge Status
GSSE (?) {i} {, j}	6-56	Gauge Status Enable
RSSW ? {i}	6-56	Read Process Status
RSSE (?) {i} {, j}	6-57	Process Status Enable

Alphabetical List of Commands

Important

Always use the GPMU command at the start of a program to ensure that the desired units are in effect.

Use VERB 0 to set the RS-232 interface to terse mode for computer programs. Use VERB 1 to use verbose mode for console communications.

Variables

i, j, d, n, p	integers
x	real number
s, t	text strings

*

*CLS	6-52	Clear Status
*ESE (?) {i} {, j}	6-54	Standard Event Enable
*ESR ? {i}	6-53	Read Standard Event Status
*IDN ?	6-47	Identification
*PSC (?) {i}	6-52	Power-On Status Clear
*RST	6-47	Reset
*SRE (?) {i} {, j}	6-53	Serial Poll Enable
*STB ? {i}	6-52	Read Serial Poll Status
*TST ?	6-46	Self-Test

B

BLEN (?) {i}	6-44	Backlight Saver Enable
BLIT (?) {i}	6-44	Backlight On/Off
BLOF (?) {n} {s}	6-44	Backlight Turn-Off Time
BLON (?) {n} {s}	6-44	Backlight Turn-On Time
BLTD (?) {n}	6-44	Backlight Delay

C

CALL ?	6-29	Calibrate RGA Detectors
CEIV ?	6-29	Calibrate RGA Electrometer
CMPX (?) n {, x}	6-24	CM PMax
CTOM (?) {n}	6-36	Move MassSpec Cursor

D

DATE (?) {s}	6-45	Date
DGAS (?) {i}	6-25	RGA Degas On/Off
DHWR ? d	6-46	Detect Hardware

E

ECMA (?) {x}	6-26	Electron Current
EEEV (?) {n}	6-25	Electron Energy
EMBV (?) {n}	6-26	RGA Electron Multiplier Bias Voltage
EMIS (?) {i}	6-26	RGA Filament Emission On/Off
ENEM (?) {i}	6-26	RGA Scan Electron Multiplier On/Off
EREQ (?) {i}	6-26	RGA Ionization Source
ERSE (?) {i} {, j}	6-55	Error Status Enable
ERSW ? {i}	6-54	Read Error Status

6-8 Index of Commands

F

FOPV (?) {n}	6-25	Focus Voltage
FREV ?	6-46	Firmware Revision

G

GADM (?) n {, i}	6-24	I/O Mode
GCMM (?) n {, i}	6-24	CM Mode
GDAS (?) n {, i}	6-24	DAC Source
GDAT ? p	6-18	Read Source Data
GDAV (?) n {, x}	6-24	Output Value
GDES (?) p {, s}	6-18	Gas Name/Port Location
GDES (?) p {, s}	6-21	Gas Name/Port Location
GDTX ? p	6-18	Read Source Data With Units
GPBA (?) n {, p}	6-17	Data Bar Assign
GPDF (?) n {, i}	6-17	Display Format
GPMU (?) {n} {s}	6-17	Pressure Units
GSSE (?) {i} {, j}	6-56	Gauge Status Enable
GSSW ? {i}	6-55	Read Gauge Status
GSTA ? p	6-19	Source Status
GSTT ? p	6-20	Source Status Time

H

HVTM (?) p {, i}	6-22	PPM Detector
------------------	------	--------------

I

IEEV (?) {i}	6-25	Ion Energy
IRFE (?) {i}	6-27	RF7 Error Handling

L

LCPN (?) {x}	6-33	Chart/MassSpec Pmin
LCPX (?) {x}	6-33	Chart/MassSpec Pmax
LCRG (?) {n}	6-33	Time Range
LCSA	6-33	Autoscale Y-Axis
LCSF	6-34	Scale X-Axis to Full
LCVN (?) {x}	6-33	Vmin
LCVX (?) {x}	6-33	Vmax
LRAT ? p	6-18	Read Leak Rate
LRCE (?) {n}	6-18	Leak Rate Coefficient
LRER (?) {0}	6-27	Last RGA Error

M

MACB ?	6-37	Read MassSpec Mass
MAME (?) p {, n}	6-21	PPM Mass
MAXM ?	6-25	Read RGA Mass Range
MENU d	6-35	Display Screen
MENU d	6-45	Display Screen
MESG (?) {s}	6-45	Message

N

NAME (?) {s}	6-45	System Name
NFTM (?) p {, n}	6-22	PPM Scan Rate

O

OABP (?) p {, i}	6-23	Alarm Beep
OAEN (?) p {, i}	6-22	PPM Alarm Enable
OALH (?) p {, x}	6-22	Alarm Level High
OALL (?) p {, x}	6-23	Alarm Level Low
OAQU ?	6-20	Read Monitor Alarm Status
OSCC ?	6-36	MassSpec Complete

P

PACB ?	6-37	Read MassSpec Peak
PASS (?) {i}	6-28	RGA Pass Through
PCME (?) p {, i}	6-21	PPM Measurement Enable
PLCL	6-30	Clear Data Log
PLDD (?) {i}	6-32	Display Date
PLDS (?) {i}	6-30	Chart/Table Display
PLEN (?) {i}	6-32	Logging Enable
PLGF ?	6-30	Read Data Log First
PLGN ?	6-30	Read Data Log Next
PLIN (?) {n}	6-31	Logging Interval
PLTR (?) {i}	6-32	TTL Reset Enable
PLWT (?) {n}	6-32	Log Length

R

RAMS (?) d {, i}	6-39	Channel Input
RBAD ?	6-43	Relay Failure Status
RBEP (?) d {, i}	6-38	Channel Beep
RDEL (?) d {, n}	6-40	Setpoint Delay
RDES (?) d {, s}	6-38	Channel Description
RGAI ?	6-25	Read RGA Identification
RGOS (?) d {, i}	6-39	Gauge Off State
RHCL	6-43	Clear Process Log
RHGF ?	6-42	Read Process Log First
RHGN ?	6-42	Read Process Log Next
RLCL (?) d {, s}	6-38	Channel Active Message
RLOP (?) d {, s}	6-38	Channel Inactive Message
RMOD (?) d {, i}	6-38	Channel Mode
RPHY (?) d {, n}	6-40	Percent Hysteresis
RPOL (?) d {, i}	6-40	Setpoint Activation
RSSE (?) {i} {, j}	6-57	Process Status Enable
RSSW ? {i}	6-56	Read Process Status
RSTA (?) d {, i}	6-39	Channel State
RTCL (?) d {, n} {, s}	6-41	Activation Time
RTIL (?) d {, i}	6-41	TTL Activation Level
RTOP (?) d {, n} {, s}	6-41	Deactivation Time
RTRP (?) d {, x}	6-39	Pressure Setpoint
RTRV (?) d {, x}	6-40	Voltage Setpoint
RVHY (?) d {, x}	6-40	Voltage Hysteresis

S

SCAN (?) {i}	6-36	Start/Stop Analog Scan
SCMF (?) {n}	6-35	MassSpec Final Mass
SCMI (?) {n}	6-35	MassSpec Initial Mass
SCOK ?	6-35	Analog Scan OK
SCRA (?) {n}	6-26	Scan Rate
SMCF (?) p {, x}	6-21	Gas Correction Factor

6-10 Index of Commands

SNUM?	6-46	Serial Number
SVGL (?) p {, i}	6-22	Set Gas via Library
SYNC?	6-28	RGA SYNC
SYSA	6-36	Autoscale MassSpec Y-Axis

T

TIME (?) {s}	6-45	Time
TTL ?	6-42	Read TTL Inputs

V

VERB (?) {i}	6-47	Verbose RS-232
VOLC (?) {n}	6-45	Volume
VRDT ?	6-46	Firmware Build

W

WSEN (?) {i}	6-47	Web Server Enable
--------------	------	-------------------

Introduction

The PPM100 Partial Pressure Monitor may be remotely programmed via its standard (1) RS-232 serial (HOST RS-232), (2) GPIB (IEEE-488) or (3) USB (Universal Serial Bus) interfaces. Any computer supporting one of these three interfaces may be used to program the PPM100. All installed interfaces are active at all times.

WARNING!

The SYNC? query is used when beginning a remote session. SYNC? forces the settings of the PPM100 to match those of the RGA. This is important if the RGA settings have been changed without the PPM100 knowing about it. If the RGA has only been under PPM100 control, then SYNC? is unnecessary. The SYNC? query takes up to 30 seconds to complete. SYNC? returns the value of the RGA status byte (see the RGA manual for details).

Communicating With RS-232

The PPM100 uses a female DB9 connector (labeled HOST RS-232) for RS-232 serial communications. The female DB9 connector is configured as a DCE (transmit on pin 2, receive on pin 3) device and supports CTS/DTR hardware handshaking. The CTS signal (pins 1, 6 and 8) is an output indicating that the PPM100 is ready, while the DTR signal (pin 7) is an input that is used to control the PPM100's data transmission. Ground is pin 5. If desired, the handshake pins may be ignored and a simple 3 wire interface (pins 2, 3 and 5) may be used. The RS-232 interface Baud Rate, Word Length, Parity and Flow Control must be set in the Main/Remote/RS-232 menu.

WARNING!

The VERB command sets the instrument's RS-232 verbosity. When controlling the PPM100 from a computer program, set VERB to 0 for terse return values and error messages. When using a terminal program, set VERB to 1 for descriptive return values and error messages. *Set VERB0 first when connecting via an RS-232 program.*

Communicating With GPIB

PPM100 supports the IEEE-488.1 (1978) interface standard. It also supports the required common commands of the IEEE-488.2 (1987) standard. Before attempting to communicate with the PPM100 over the GPIB interface, the PPM100's Device Address must be set in the Main/Remote/GPIB menu.

Communicating with USB

PPM100 supports USB (Universal Serial Bus) communication with PCs. The USB interface makes setup and communication very simple. Simply connect the USB cable between the PPM100 and USB port on the computer, download the required drivers into your computer, power up the PPM100, and hardware setup is finished.

Consult the USB Setup section at the end of this chapter for details.

Screen Indicators And Queues

To assist in programming, the PPM100 has an interface activity indicator displayed in the upper right corner of the screen (next to the time). The arrow symbol \updownarrow flashes whenever there is interface activity (transmit or receive). The **X** symbol indicates a computer interface error has occurred, such as an illegal command or out of range parameter is received. The **SRQ** indicator is on when the PPM100 generates a GPIB service request. **SRQ** stays on until a GPIB serial poll is completed.

To help find program errors, the PPM100 can display the interface buffers on the screen. This screen is accessed by touching [Queue] in the Main/Remote/RS-232, GPIB or USB menus. The Queue display may slow down communications and should be displayed only when testing or debugging a host program. Press a QuickKey to exit from this display.

The upper half of the Queue display is the Receive Queue. These are the most recent characters which have been received by the PPM100 (displayed in all UPPER case). Commands which have already been executed are shown in normal text. Commands which have not yet been executed are shown with a gray background. Command errors are shown in inverse text.

The lower half of the Queue display is the Transmit Queue. These are the most recent characters which have been placed in the output buffer. Characters which have already been sent over the interface are shown in normal text. Characters which are waiting to be sent are shown with a gray background.

Command Format

Communications with the PPM100 uses ASCII characters. Commands may be in either UPPER or lower case. A command to the PPM100 consists of a four character command mnemonic with optional ?, arguments if necessary, and a command terminator. The command, arguments and terminator may be separated by spaces. The terminator must be a linefeed <lf> or carriage return <cr> on RS-232 and USB, or a linefeed <lf> or EOI on GPIB. No command processing occurs until a terminator is received. Commands function identically on all interfaces whenever possible. Command mnemonics beginning with an asterisk '*' are IEEE-488.2 (1987) defined common commands. These commands also function identically on RS-232 and USB whenever possible. Commands may require one or more parameters. Multiple parameters are separated by commas (,).

Multiple commands may be sent on one command line by separating them with semicolons (;). In this case, no commands are executed until a terminator is received.

There is no need to wait between commands. The PPM100 has a 256 character input buffer and processes commands in the order received. If the buffer fills up, the PPM100 will hold off handshaking on the GPIB and attempt to hold off handshaking on RS-232. Similarly, the PPM100 has a 256 character output buffer to store output until the host computer is ready to receive it. If either buffer overflows, both buffers are cleared and an error reported.

The present value of a particular parameter may be determined by querying the PPM100 for its value. A query is formed by appending a question mark '?' to the command mnemonic and omitting the desired parameter from the command. Values returned by the PPM100 are sent as a string of ASCII characters terminated by a carriage return <cr> on RS-232 and USB and by a line-feed <lf> on GPIB. If multiple query commands are sent on one command line (separated by semicolons, of course), the answers will be returned individually, each with a terminator.

Examples of Commands

GADM 4, 1 <lf>	Set Analog Port 4 to DAC output mode
GADM? 4 <lf>	Query the mode of Analog Port 4
GDAT? 1 <lf>	Query the reading of PP1
*IDN ? <lf>	Query the Device Identification String

Command Synchronization

IFC (Interface Ready, bit 7) in the Serial Poll status signals that the PPM100 is ready to receive and execute a command. When a command is received, this bit is cleared, indicating that command execution is in progress. No other commands will be processed until this command is completed. Commands received during this time are stored in the buffer to be processed later. Only GPIB serial polling will generate a response while a command is in progress. When all pending commands have executed, the IFC bit is set again. By checking IFC with serial polls, a host computer can ensure that all previously sent commands have finished before sending a new command.

Since most commands execute very quickly, the host computer does not need to continually check the IFC bit. Commands may be sent one after another and they will be processed immediately.

However, some commands may require a long time to execute. In addition, the host program may need to check that these operations executed without error. In these cases, after the command is sent, the status should be queried.

When using the GPIB interface, serial polling may be used to check the IFC bit in the Serial Poll status while an operation is in progress. After the IFC bit becomes set, signaling the completion of the command, then the ESB (Event Status) bit may be checked to verify successful completion of the command.

If the RS-232 or USB interface is used, or serial polling is not available, then the *STB? query command may be used to read the Serial Poll status word. However, *STB *NEVER* returns the IFC bit set (since *STB is itself a command).

Since the PPM100 processes one command at a time, status queries will not be processed until the previous operation is finished. Thus a response to a status query in itself signals that the previous command is finished. The query response may then be checked for various errors.

RGA Commands

The PPM100 is capable of detecting and handling all native RGA commands. For more information on RGA commands, see the *SRS RGA Operation and Programming Manual*.

Once a valid RGA command is received by the PPM100 (over any interface), it is immediately transmitted to the RGA (through the RGA RS-232 port) without any changes. The responses from the RGA are also detected by the PPM100 and sent back to the host computer over the same computer interface.

PPM100 to RGA Communication

Pending Commands

Many PPM100 commands cause the PPM100 to send commands to the RGA head (via the RGA RS-232 port). Since the PPM100 can receive commands from the host computer via an interface which is faster than the RGA RS-232 connection, it is possible that the PPM100 will start to accumulate a backlog of commands for the RGA.

The RCC bit (bit 3) in the Serial Poll Status register is cleared when the PPM100 has pending commands for the RGA. A safe way of using GPIB commands is to serial poll until RCC becomes set between PPM100 commands to make sure that the RGA is keeping up.

No Communication with RGA

The RGA_Com bit (bit 0) of the Gauge Status word is set whenever the PPM100 detects a problem with the communication link to the RGA head. This includes the RGA head power being turned off or the cable to the RGA being disconnected.

RGA Pass Through Mode

When RGA Pass Through is enabled, the PPM100 will pass *ALL* commands received via the Host RS-232 port directly to the RGA and all responses from the RGA will be transmitted from the Host RS-232 port. The Host RS-232 port is also set to emulate the serial port on the RGA itself. This allows the host computer to run RGA Windows (or other direct RGA software) without changing any serial cables.

Once Pass Through is enabled, the PPM100 will not recognize any PPM100 commands it receives via the Host RS-232 port. Only native RGA commands should be sent!

After using Pass Through mode, the SYNC command should be used to synchronize the PPM100 with the RGA.

Important

The PPM100 will not perform any RGA-related activity while in Pass Through mode. Only measurements related to the Analog ports continue.

Command Syntax

The four letter mnemonic (shown in CAPS) in each command sequence specifies the command. The rest of the sequence consists of parameters. Parameters shown in { } are not always required. Generally, parameters in { } are required to set a value in the PPM100. Multiple parameters are separated by commas. Multiple commands may be sent on one command line by separating them with semicolons (;).

The present value of a parameter may be determined by sending a query command.

- Commands that **MAY** be queried show a question mark in parentheses (?) after the mnemonic.
- Commands that are **ONLY** queries have a '?' after the mnemonic, with no parentheses.
- Commands that **MAY NOT** be queried have no '?'.

A query is formed by including the question mark ? after the command mnemonic and omitting the queried parameter from the command. The query parameters shown in { } are **NOT** sent with a query. The query returns the value of these parameters. Values are returned as a string of ASCII characters (unless otherwise noted).

Do **NOT** send () or { } as part of the command.

For example, the command sequence GADM (?) i {, j} is used as follows.

GADM 1, 0	Set the Analog Port 1 to ADC Input mode.
GADM ? 1	Query the mode of Analog Port 1.

Variables are defined as follows.

i, j, d, n, p	integers
x	real number
s, t	text strings

Commands to set values which may be different for each port require the p parameter. These values must be queried separately for each port.

All numeric variables may be expressed in integer, floating point or exponential formats (i.e. the number five can be either 5, 5.0, or 0.5E1). Strings are sent as a sequence of ASCII characters.

Pressure Units

The entire PPM100 operates with a **SINGLE** units system. All commands that query or set pressure parameters use the global units system of the PPM100. The units may be changed in the Main Menu or with the GPMU command.

For example, if the PPM100 units are Torr, all commands that query pressures will return values in Torr. All commands that set pressures must send values in Torr.

All pressure parameters have minimum and maximum allowed values. These values are converted to the current units and may not be exceeded in a command. These limits are displayed in the entry screen when entering new values from the front panel.

WARNING!

Always use the GPMU command at the start of a program to ensure that the desired units are in effect.

Partial Pressure and Analog Input Measurement Commands

GPMU (?) {n} {s} **Pressure Units**

The GPMU command sets (queries) the system pressure units. The parameter n selects the units system below, or use string s ("micron", "bar", etc.). Do not use both n and s.

<u>n</u>	<u>units</u>
0	Torr
1	micron
2	bar
3	mbar
4	Pascal

Example

GPMU?	Returns the pressure units n.
GPMU 1	Sets the pressure units to microns.
GPMU pascal	Sets the pressure units to Pascal.

GPBA (?) n {, p} **Data Bar Assign**

The GPBA command sets (queries) the Data Bar assignments in the Pressure Display (ID Box). The parameter n selects Upper (0), Middle (1) or Lower (2) Data Bar and is required. The parameter p selects a source/port below.

<u>p</u>	<u>source</u>	<u>p</u>	<u>source</u>	<u>p</u>	<u>source</u>	<u>p</u>	<u>source</u>
1	PP1	5	PP5	9	CM1	13	AN1
2	PP2	6	PP6	10	CM2	14	AN2
3	PP3	7	PP7	11	CM3	15	AN3
4	PP4	8	PP8	12	CM4	16	AN4

Example

GPBA? 0	Returns the ID p of the upper Data Bar.
GPBA 2, 3	Sets the lower Data Bar to PP3.

GPDF (?) n {, i} **Display Format**

The GPDF command sets (queries) the Display Format of a Data Bar. The parameter n selects Upper (0), Middle (1) or Lower (2) Data Bar and is required. The parameter i selects a Display Format below.

<u>i</u>	<u>format</u>	<u>i</u>	<u>format</u>
0	Big Numbers	4	Auto Scaling Bar Graph
1	Trend Graph	5	Full Range Bar Graph
2	Silent Leak Trend	6	Gauge Status Information
3	Audio Leak Trend	7	Leak Rate

Examples

GPDF? 0	Returns the display format i of the upper Data Bar.
GPDF 2, 3	Sets the lower Data Bar to Full Scale Bar Graph.

GDAT ? p

Read Source Data

The GDAT? query returns the reading from source/port p in the current units. The parameter p selects a source below and is required.

<u>p</u>	<u>source</u>	<u>p</u>	<u>source</u>	<u>p</u>	<u>source</u>	<u>p</u>	<u>source</u>
1	PP1	5	PP5	9	CM1	13	AN1
2	PP2	6	PP6	10	CM2	14	AN2
3	PP3	7	PP7	11	CM3	15	AN3
4	PP4	8	PP8	12	CM4	16	AN4

The returned string has the form "+1.000e-009" with current units implied.

If the RGA is off or disconnected, reading a partial pressure results in an error. If an analog port has its CM Display Off or is configured as an output, reading the CM gauge results in an error.

Example

GDAT? 1 Returns the reading of PP1 in the current units.

GDTX ? p

Read Source Data With Units

The GDTX? query returns the reading from source/port p with units. The parameter p selects a source below and is required.

<u>p</u>	<u>source</u>	<u>p</u>	<u>source</u>	<u>p</u>	<u>source</u>	<u>p</u>	<u>source</u>
1	PP1	5	PP5	9	CM1	13	AN1
2	PP2	6	PP6	10	CM2	14	AN2
3	PP3	7	PP7	11	CM3	15	AN3
4	PP4	8	PP8	12	CM4	16	AN4

The returned string has the form "1.00-09 Torr". This string is identical to data display on the screen.

Example

GDTX? 1 Returns the reading of PP1 *with* the current unit string.

LRAT ? p

Read Leak Rate

The LRAT? query returns the leak rate for partial pressure p in the current units. The Leak Rate Coefficient (LRCE command) must be set for this query to be meaningful. The parameter p selects a source below and is required.

<u>p</u>	<u>source</u>	<u>p</u>	<u>source</u>	<u>p</u>	<u>source</u>
1	PP1	5	PP5	9	CM1
2	PP2	6	PP6	10	CM2
3	PP3	7	PP7	11	CM3
4	PP4	8	PP8	12	CM4

The returned string has the form "+1.000e-007".

Example

LRAT? 1 Returns the leak rate of PP1.

LRCE (?) {n}

Leak Rate Coefficient

The LRCE command sets (queries) the Leak Rate Coefficient. The parameter n is an integer from 1 to 3000.

Examples

LRCE? Returns the Leak Rate Coefficient.
LRCE 500 Sets the Leak Rate Coefficient to 500.

GDES (?) p {, s}

Gas Name/Port Location

The GDES command sets (queries) the gas name or port location string. The parameter p selects a source below and is required. The string s is the name or location string.

<u>p</u>	<u>source</u>	<u>p</u>	<u>source</u>	<u>p</u>	<u>source</u>	<u>p</u>	<u>source</u>
1	PP1	5	PP5	9	CM1	13	AN1
2	PP2	6	PP6	10	CM2	14	AN2
3	PP3	7	PP7	11	CM3	15	AN3
4	PP4	8	PP8	12	CM4	16	AN4

Examples

GDES 3, WATER Sets the gas name of PP3 to "WATER".
 GDES? 3 Returns the gas name of PP3 ("WATER" in this case).

GSTA ? p

Source Status

The GSTA? query returns the status of source/port p. The parameter p selects a source below and is required.

<u>p</u>	<u>source</u>	<u>p</u>	<u>source</u>	<u>p</u>	<u>source</u>	<u>p</u>	<u>source</u>
1	PP1	5	PP5	9	CM1	13	AN1
2	PP2	6	PP6	10	CM2	14	AN2
3	PP3	7	PP7	11	CM3	15	AN3
4	PP4	8	PP8	12	CM4	16	AN4

The returned value is an integer n described below.

<u>n</u>	<u>description</u>
0	The gauge is operating normally.
2	The reading is underrange.
3	The reading is overrange.
4	The reading is not yet accurate.
5	There is no data from this DAC source.
7	PPM100 is scanning and is not measuring partial pressures.
8	Another source is displaying Leak Trend, this source is disabled.
9	Source is disabled.
10	ADC is overloaded.
11	The A/D is in DAC output mode. CM gauge not running.
12	External gauge is off (Voltage < 1V).
13	External gauge shows fault condition (Voltage > 10V).
15	There is no data to display.
16	RGA filament is off.
18	No RGA detected.
19	A TTL port was used to turn the source/port off.
20	No measurement - RS232 port is in RGA Pass Through Mode
21	The controller detected a fault.
22	There is no hardware to run the source/port.

See the GSTT? command.

Example

GSTA? 9 Returns 0 if CM1 is operating normally.

6-20 Partial Pressure/Analog Measurement

GSTT ? p

Source Status Time

The GSTT? query returns the time and date that source/port p last changed status. The parameter p selects a source below and is required.

<u>p</u>	<u>source</u>	<u>p</u>	<u>source</u>	<u>p</u>	<u>source</u>	<u>p</u>	<u>source</u>
1	PP1	5	PP5	9	CM1	13	AN1
2	PP2	6	PP6	10	CM2	14	AN2
3	PP3	7	PP7	11	CM3	15	AN3
4	PP4	8	PP8	12	CM4	16	AN4

See the GSTA? command.

Example

GSTT? 9 Returns a string of the form "13:50 05aug03".

OAQU ?

Read Monitor Alarm Status

The OAQU? query returns an 8 bit integer corresponding to the state of the partial pressure alarms. Bit 0 is 1 if PP1 alarm is on, bit 1 is 1 if PP2 alarm is on, etc.

Example

OAQU? Returns 5 if PP1 and PP3 alarms are on.

PPM Monitor Setup Commands

PCME (?) p {, i}

PPM Measurement Enable

The PCME command sets (queries) the PPM Measurement mode (enabled/disabled) for partial pressure monitor p. The parameter p selects PP1 (1) through PP8 (8) and is required. The parameter i selects disabled (0) or enabled (1).

Examples

PCME? 2 Returns the Measurement Enable state (0 or 1) of PP2.
 PCME 2, 1 Enable PP2 measurement.

MAME (?) p {, n}

PPM Mass

The MAME command sets (queries) the mass for partial pressure monitor p. The parameter p selects PP1 (1) through PP8 (8) and is required. The parameter n is the mass in AMU (1-300).

Note

The actual mass range is determined by the model of RGA connected to the PPM100.

Examples

MAME? 1 Returns the mass of PP1.
 MAME 1, 18 Sets the mass of PP1 to 18 AMU.

GDES (?) p {, s}

Gas Name/Port Location

The GDES command sets (queries) the gas name or port location string. The parameter p selects a source below and is required. The string s is the name or location string.

p	source	p	source	p	source	p	source
1	PP1	5	PP5	9	CM1	13	AN1
2	PP2	6	PP6	10	CM2	14	AN2
3	PP3	7	PP7	11	CM3	15	AN3
4	PP4	8	PP8	12	CM4	16	AN4

Examples

GDES 3, WATER Sets the gas name of PP3 to "WATER".
 GDES? 3 Returns the gas name of PP3 ("WATER" in this case).

SMCF (?) p {, x}

Gas Correction Factor

The SMCF command sets (queries) the Correction Factor for partial pressure monitor p. The parameter p selects PP1 (1) through PP8 (8) and is required. The parameter x is the Correction Factor (unitless).

Examples

SMCF? 2 Returns the Correction Factor x of PP2.
 SMCF 2, 1.8 Sets the PP2 Correction Factor to 1.8.

SVGL (?) p {, i}**Set Gas via Library**

The SVGL command sets (queries) the Gas Name and Mass via Library for partial pressure monitor p. The parameter p selects PP1 (1) through PP8 (8) and is required. The parameter i selects a library entry below.

i	<u>input</u>	i	<u>input</u>
0	hydrogen	6	pump oil
1	helium	7	carbon dioxide
2	water	8	methane
3	nitrogen	9	neon
4	oxygen	10	krypton
5	argon	11	unknown

Examples

SVGL? 5 Returns the library entry used by PP5.
SVGL 5, 4 Sets the name and mass of PP5 to oxygen.

NFTM (?) p {, n}**PPM Scan Rate**

The NFTM command sets (queries) the Scan Rate for partial pressure monitor p. The parameter p selects PP1 (1) through PP8 (8) and is required. The parameter n is the Scan Rate (1-8).

Examples

NFTM? 8 Returns the Scan Rate n of PP8.
MAME 8, 5 Sets the Scan Rate of PP8 to 5.

HVTM (?) p {, i}**PPM Detector**

The HVTM command sets (queries) the PPM Detector for partial pressure monitor p. The parameter p selects PP1 (1) through PP8 (8) and is required. The parameter i selects Faraday Cup (0) or Electron Multiplier (1).

Examples

HVTM? 4 Returns the Detector setting (0 or 1) of PP4.
HVTM 4, 1 Set PP4 to use the CDEM detector.

OAEN (?) p {, i}**PPM Alarm Enable**

The OAEN command sets (queries) the PPM Alarm mode (enabled/disabled) for partial pressure monitor p. The parameter p selects PP1 (1) through PP8 (8) and is required. The parameter i selects disabled (0) or enabled (1).

Examples

OAEN? 2 Returns the Alarm Enable state (0 or 1) of PP2.
OAEN 2, 1 Enable PP2 Alarm.

OALH (?) p {, x}**Alarm Level High**

The OALH command sets (queries) the Alarm High Level of partial pressure monitor p. The parameter p selects PP1 (1) through PP8 (8) and is required. The parameter x is the Alarm High Level expressed in the current system units.

Examples

OALH? 1 Returns the Alarm High Level for PP1 in the current units.
OALH 1, 1.2E-3 Set the Alarm High Level for PP1 to 0.0012 in current units.

OALL (?) p {, x}**Alarm Level Low**

The OALL command sets (queries) the Alarm Low Level of partial pressure monitor p. The parameter p selects PP1 (1) through PP8 (8) and is required. The parameter x is the Alarm Low Level expressed in the current system units.

Examples

OALL? 1 Returns the Alarm Low Level for PP1 in the current units.
OALL 1, 3.4E-5 Sets the Alarm Low Level for PP1 to 0.000034 in the current units.

OABP (?) p {, i}**Alarm Beep**

The OABP command sets (queries) the Alarm Beep mode (on/off) of partial pressure monitor p. The parameter p selects PP1 (1) through PP8 (8) and is required. The parameter i selects off (0) or on (1).

Examples

OABP? 1 Returns the Alarm Beep mode for PP1.
OABP 1, 0 Sets the Alarm Beep mode for PP1 to off.

Analog I/O Setup Commands

GADM (?) n {, i}	I/O Mode <p>The GADM command sets (queries) the I/O Mode of analog port n. The parameter n (1-4) selects AN1-AN4 and is required. The parameter i selects ADC Input (0) or DAC Output (1).</p> <p>Examples</p> <p>GADM? 4 Returns the AN4 I/O Mode i. GADM 4, 1 Sets AN4 into DAC Output mode.</p>
GDAS (?) n {, i}	DAC Source <p>The GDAS command sets (queries) the DAC Source for analog port n. The parameter n (1-4) selects AN1-AN4 and is required. The parameter i selects Manual (0) or PP1-PP8 (1-8).</p> <p>Examples</p> <p>GDAS? 1 Returns the AN1 DAC Source i. GDAS 1, 2 Sets the AN1 DAC Source to PP2.</p>
GCMM (?) n {, i}	CM Mode <p>The GCMM command sets (queries) the CM Mode for analog port n. The parameter n (1-4) selects AN1-AN4 and is required. The parameter i selects Off (0), Linear (1) or Log (2).</p> <p>Examples</p> <p>GCMM? 1 Returns the CM Mode for AN1. GCMM 1, 1 Sets the CM Mode for AN1 to Linear.</p>
GDAV (?) n {, x}	Output Value <p>The GDAV command sets (queries) the DAC output value for analog port n. This is the output voltage when the analog port is a DAC Output and the DAC Source is Manual. The parameter n (1-4) selects AN1-AN4 and is required. The parameter x is an output voltage (in Volts).</p> <p>Examples</p> <p>GDAV? 1 Returns the AN1 DAC output value in Volts. GDAV 1, 2.5 Sets the AN1 DAC output value to 2.5 V.</p>
CMPX (?) n {, x}	CM PMax <p>The CMPX command sets (queries) the Maximum Pressure (Pmax) of capacitance manometer n (1-4 for CM1-4). The parameter x is the pressure Pmax in the current units.</p> <p>Examples</p> <p>CMPX 1, 100.0 Set Pmax of CM1 to 100.0 in the current units. CMPX? 1 Return the value of Pmax for CM1 in the current units.</p>

RGA Commands

These commands set and query settings inside the RGA head. For more information about these parameters, please see the RGA manual. Communication between the PPM100 Controller and the RGA head may be slower than the host PC interface to the PPM100 so allow time for these commands to execute. Sending many RGA commands in quick succession may cause the RGA to fall behind and the PPM100 to abort pending commands.

MAXM ?	<p>Read RGA Mass Range</p> <p>The MAXM? query returns the mass range of the RGA, either 100, 200 or 300 (amu).</p> <p>Example MAXM? Returns 300 for an RGA300.</p>
RGAI ?	<p>Read RGA Identification</p> <p>The RGA? query returns the RGA identification string. This string has the form "SRGA300VER0.24SN08560". The string contains the RGA model number, firmware version and serial number.</p> <p>Example RGAI? Returns the RGA ID string.</p>
EEEEV (?) {n}	<p>Electron Energy</p> <p>The EEEV command sets (queries) the Electron Energy in eV. The parameter n is an integer (25-105) with units of eV. The default is 70.</p> <p>Examples EEEEV? Returns the Electron Energy in eV. EEEEV 100 Sets the Electron Energy to 100 eV.</p>
IEEV (?) {i}	<p>Ion Energy</p> <p>The IEEV command sets (queries) the Ion Energy. The parameter i selects Low 8eV (0) or High 12eV (1). The default is High (1).</p> <p>Examples IEEV? Returns the Ion Energy setting (0 or 1). IEEV 1 Sets the Ion Energy to High 12eV.</p>
FOPV (?) {n}	<p>Focus Voltage</p> <p>The FOPV command sets (queries) the Focus Voltage. The parameter n is an integer (0-150) with units of Volts. The default is 90.</p> <p>Examples FOPV? Returns the Focus Voltage in Volts. FOPV 90 Sets the Focus Voltage to 90 Volts.</p>

SCRA (?) {n}	<p>Scan Rate</p> <p>The SCRA command sets (queries) the Scan Rate. The parameter n is an integer (1-8). The default is 5.</p> <p>Examples</p> <p>SCRA? Returns the Scan Rate (1-8).</p> <p>SCRA 3 Sets the Scan Rate to 3.</p>
<hr/>	
ECMA (?) {x}	<p>Electron Current</p> <p>The ECMA command sets (queries) the Electron Current. The parameter x (0.02-3.5) is the current in mA. The default is 1.00.</p> <p>Examples</p> <p>ECMA? Returns the Electron Current in mA.</p> <p>ECMA 1.5 Sets the Electron Current to 1.5 mA.</p>
<hr/>	
EMIS (?) {i}	<p>RGA Filament Emission On/Off</p> <p>The EMIS command turns RGA Filament Emission On (i=1) or Off (i=0). This command duplicates the function of the 'FILAMENT' button on the front panel. EMIS? queries whether the RGA Filament is on or off.</p> <p>Turning Filament Emission OFF will cancel any pending commands to the RGA. If commands changing RGA settings immediately precede the EMIS 0 command, they may not be executed. Verify the RGA settings before turning emission on again.</p> <p>Examples</p> <p>EMIS? Returns 1 if RGA Filament is on, 0 if off.</p> <p>EMIS 1 Turns RGA Filament on.</p>
<hr/>	
ENEM (?) {i}	<p>RGA Scan Electron Multiplier On/Off</p> <p>The ENEM command turns the RGA Scan Electron Multiplier On (i=1) or Off (i=0). This command duplicates the function of the 'E. MULTIPLIER' button on the front panel. ENEM? queries whether the RGA Scan Electron Multiplier is on or off.</p> <p>The RGA Scan Electron Multiplier may only be turned on during analog scans (MassSpec Display).</p> <p>Examples</p> <p>ENEM? Returns 1 if RGA Electron Multiplier is on, 0 if off.</p> <p>ENEM 1 Turns RGA Electron Multiplier on.</p>
<hr/>	
EMBV (?) {n}	<p>RGA Electron Multiplier Bias Voltage</p> <p>The EMBV command sets (queries) the electron multiplier bias voltage. The parameter n is the bias voltage in Volts (0 or 10-2490). The default is 1400.</p> <p>This command fails if the RGA does not have an electron multiplier.</p> <p>Examples</p> <p>EMBV? Returns electron multiplier bias in volts.</p> <p>EMBV 1000 Sets the electron multiplier bias to 1000 Volts.</p>

EREQ (?) {i}**Ionization Source**

The EREQ command sets (queries) the RGA Ionization Source to RGA Filament (i=1) or External (i=0). If set to RGA Filament, the PPM100 will not measure pressures without RGA filament emission being on.

Examples

EREQ? Returns RGA Ionization Source (0 or 1).
EREQ 1 Sets RGA Ionization Source to RGA Filament.

IRFE (?) {i}**RF7 Error Handling**

The IRFE command sets (queries) the RF7 Error Handling to Ignore (i=1) or Warn (i=0). If set to Ignore, the PPM100 will ignore the RF7 error from 300 AMU RGA units.

Examples

IRFE? Returns 1 if Ignore RF7, 0 if Warn on RF7.
IRFE 1 Sets RF7 Error Handling to Ignore.

LRER (?) {0}**Last RGA Error**

If the PPM100 encounters an RGA status error code while running or scanning it will halt and briefly display an error message. The LRER? query returns the code (i) for that message. This code is cleared by the LRER 0 command.

<u>i</u>	<u>name</u>	<u>description</u>
0		No error
1		Unknown error
2	RS6	RS232 parameter conflict
3	RS1	Bad RS232 parameter
4	RS4	RS232 transmit buffer overwrite
5	RS3	RS232 receive buffer overwrite
6	RS0	Bad RS232 command
7	RS2	RS232 command too long
8	RS5	RS232 jumper protection violation
9	EM7	The RGA doesn't have an electron multiplier
10	DET1	Electrometer op-amp input voltage out of range
11	DET3	Electrometer compensate can't read -5nA
12	DET4	Electrometer compensate can't read +5nA
13	DET5	Electrometer detect can't read -5nA
14	DET6	Electrometer detect can't read +5nA
15	DET7	Electrometer ADC failure
16	FL0	Single filament operation
17	FL5	Vacuum chamber pressure too high
18	FL6	Filament unable to set requested emission current
19	FL7	No filament detected
20	RF4	RF power supply in current limit mode
21	RF6	RF power supply current >2.0A
22	RF7	RF power supply RF_CT exceeds limit.
23	PS6	External 24V power supply <22V
24	PS7	External 24V power supply >26V

Examples

LRER? Return RGA error code i.
LRER 0 Clear the last RGA error.

PASS (?) {i}**RGA Pass Through**

The PASS command sets the RGA Pass Through to Normal Operation (i=0) or Pass Through (i=1). If set to Pass Through, the PPM100 will pass all characters received via the Host RS-232 port directly to the RGA and all responses from the RGA will be transmitted from the Host RS-232 port. The Host RS-232 port is also set to emulate the serial port on the RGA itself. This allows the host computer to run RGA Windows (or other direct RGA software) without changing any serial cables.

This command should *not be used* over the RS-232 interface. Once Pass Through is enabled, the PPM100 will *not recognize* any PPM100 commands it receives via the Host RS-232 port, thus the PASS 0 command will *not* work to restore normal PPM100 operation. Use the USB or GPIB port to issue the PASS 0 command or restore normal operation via the front panel.

When PASS 0 is used to return to normal mode, the Host RS-232 port settings are *not* restored to their previous settings.

After using PASS 0, the SYNC? query should be used to synchronize the PPM100 with the RGA.

Important

The PPM100 will not perform any RGA-related activity while in Pass Through mode. Only measurements related to the Analog ports continues.

Examples

PASS?	Returns the RGA Pass Through Mode.
PASS 1	Enable the RGA Pass Through Mode.

SYNC?**RGA SYNC**

The SYNC? query is used when beginning a remote session. SYNC? forces the settings of the PPM100 to match those of the RGA. This is important if the PPM100 has been in RGA Pass-Through mode (running RGA Windows for example) and the RGA settings have been changed without the PPM100 knowing about it. If the RGA has only been under PPM100 control, then SYNC? is unnecessary.

The SYNC? query takes up to 30 seconds to complete. SYNC? returns the value of the RGA status byte (see the RGA manual for details).

Important

Do not send any other RGA commands until the response to SYNC? has been received!

Another way to accomplish the same thing is to run an initialization routine which sets every parameter in the PPM100 that is required for the measurement. This will ensure that the RGA settings are in agreement with the PPM100.

Example

SYNC?	Synchronize the PPM100 with the RGA and return the RGA status byte.
-------	---

Warning!

The following commands (CALL, CEIV and DGAS) all interrupt PPM100 partial pressure measurements. All process channels must be set to a safe manual state, either Active or Inactive, prior to calibrating or degassing the RGA.

CALL ?**Calibrate RGA Detectors**

The CALL? query calibrates all RGA detectors and returns the RGA status when complete. See the RGA manual for details. This process takes about a minute and no other commands to the RGA should be sent during this time.

Note

This corresponds to the RGA's CA command.

Example

CALL? Perform detector calibration and return the RGA status.

CEIV ?**Calibrate RGA Electrometer**

The CEIV? query calibrates the RGA electrometer's I-V response and returns the RGA status when complete. See the RGA manual for details. This process takes about a minute and no other commands to the RGA should be sent during this time.

Note

This corresponds to the RGA's CL command and the Calibrate Electrometer button in the RGA menu.

Example

CEIV? Perform electrometer calibration and return the RGA status.

DGAS (?) {i}**Degas On/Off**

The DGAS i command turns RGA Degas On (i=1) or Off (i=0). DGAS? queries whether degas is on or off.

DGAS 1 will turn Degas On. If no other command is sent to the RGA then degas will last 3 minutes and then turn off. If DGAS 0 or another RGA command is sent before 3 minutes, degas will turn off immediately.

Examples

DGAS? Returns 1 if RGA Degas is on, 0 if Degas is off.

DGAS 1 Turns RGA Degas on.

Logging Commands

PLDS (?) {i}	Chart/Table Display
	The PLDS command sets (queries) the Data Log Display to Chart (i=0) or Table (i=1).
	Examples
PLDS?	Returns 0 for Chart and 1 for Table.
PLDS 0	Sets the Log Display to Chart.

PLCL	Clear Data Log
	The PLCL command clears the Data Log. All entries in the Data Log are lost after sending the PLCL command.
	Example
PLCL	Clear the Data Log.

PLGF ? PLGN ?	Read Data Log
	The PPM100 logs all pressure/analog/process readings in the Data Log. To read the log, use the PLGF? query to return the most recent entry in the log. Then issue PLGN? repeatedly to get the rest of the entries, until the string "&" is returned, signaling that all entries have been read.
	This command pair retrieves the log as it was when the PLGF? command was received. Log entries created while you download the log do not appear in it. If you try to retrieve history over two interfaces at the same time you will not get the complete history on either.
	WARNING!
	The Embedded Web Server continually issues PLGF and PLGN. If you have the web server option, you must disable it (from the Remote/Web menu or with the WSEN command) to use these commands.
	These commands return a string with the following fields separated by commas:
	<ul style="list-style-type: none">• Date in DDMMYY format "06oct03".• Time in 24 hour format "16:42".• PP1 data.• PP2 data.• PP3 data.• PP4 data.• PP5 data.• PP6 data.• PP7 data.• PP8 data.• CM1 data.• CM2 data.

- CM3 data.
- CM4 data.
- AN1 data.
- AN2 data.
- AN3 data.
- AN4 data.
- Process control bitfield. The first digit is channel 8, the last digit is channel 1. A '1' means the channel is active, '0' means inactive.
- TTL input bitfield. The first digit is channel 8, the last digit is channel 1. A '1' means the input is high, '0' means low.

Data that isn't available shows up as an asterix '*'.

All pressure readings are expressed in the current units. All ADC inputs are in Volts.

Example

The returned string

```
"06oct03,16:42,1.64-06,*,*,2.34-01,*,*,*,*,
1.2-02,*,*,*0.046,7.34,-0.029,-0.029,
00000100,11111111"
```

has the following interpretation:

- This data was sampled at 4:42 PM on October 6, 2003.
- PP1 read 1.64e-6 in the current units.
- PP2 and PP3 were off (no data available).
- PP4 read 2.34e-1 in the current units.
- PP5 through PP8 were off.
- CM1 read 1.2e-3 in the current units.
- CM2 through CM4 were off.
- AN1 read 0.046V.
- AN2 read 7.34 V.
- AN3 and 4 read -0.029 V
- Process control channel 3 is active, all others are inactive.
- All Process TTL inputs are high (inactive).

PLIN (?) {n}

Logging Interval

The PLIN command sets (queries) the Logging Interval. The parameter n is the Logging Interval in milliseconds. This command will change the Log Length as well.

Note

Times are stored in milliseconds, but this timer is only accurate to within a second.

Examples

```
PLIN?           Returns the Logging Interval n in ms.
PLIN 60000     Sets the Logging Interval to 1 minute (60,000 ms).
```

PLWT (?) {n}	Log Length The PLWT command sets (queries) the Log Length. The parameter n is the Log Length in seconds. This command will change the Logging Interval. Examples PLWT? Returns the Log Length n in seconds. PLWT 3600 Sets the Log Length to 1 hours (3600 sec).
PLEN (?) {i}	Logging Enable The PLEN command sets (queries) whether Data Logging is enabled. The parameter i selects Log/Enabled (1) or Pause/Disabled (0). Examples PLEN? Returns 1 if logging is enabled, 0 if disabled. PLEN 1 Turns data logging on.
PLDD (?) {i}	Display Date The PLDD command sets (queries) whether Date Display (in Table display format) is Enabled (i=1) or Disabled (i=0). Examples PLDD? Returns 1 if Date Display is enabled, 0 if disabled. PLDD 1 Turns Date Display on.
PLTR (?) {i}	TTL Reset Enable The PLTR command sets (queries) whether the TTL Log Reset input is Enabled (i=1) or Disabled (i=0). Examples PLTR? Returns 1 if TTL Log Reset input is enabled, 0 if disabled. PLTR 1 Enables TTL Log Reset input.

Charting Commands

LCPN (?) {x}	<p>Chart/MassSpec Pmin</p> <p>The LCPN command sets (queries) the value of the Chart/MassSpec Y-Axis Pmin. The parameter x is a pressure expressed in the current units.</p> <p>Examples</p> <p>LCPN? Returns the value of Pmin in the current pressure units.</p> <p>LCPN 1.3e-10 Sets Pmin to 1.3×10^{-10} in the current units..</p>
<hr/>	
LCPX (?) {x}	<p>Chart/MassSpec Pmax</p> <p>The LCPX command sets (queries) the value of the Chart/MassSpec Y-Axis Pmax. The parameter x is a pressure expressed in the current units.</p> <p>Examples</p> <p>LCPX? Returns the value of Pmax in the current pressure units.</p> <p>LCPX 1.3e-6 Sets Pmax to 1.3×10^{-6} in the current units.</p>
<hr/>	
LCVN (?) {x}	<p>Vmin</p> <p>The LCVN command sets (queries) the value of the Chart Y-Axis Vmin. The parameter x is expressed in Volts.</p> <p>Examples</p> <p>LCVN? Returns the value of Vmin in Volts.</p> <p>LCVN -10.0 Sets Vmin to -10.0 Volts.</p>
<hr/>	
LCVX (?) {x}	<p>Vmax</p> <p>The LCVX command sets (queries) the value of the Chart Y-Axis Vmax. The parameter x is expressed in Volts.</p> <p>Examples</p> <p>LCVX? Returns the value of Vmax in Volts.</p> <p>LCVX 10.0 Sets Vmax to +10.0 Volts.</p>
<hr/>	
LCSA	<p>Autoscale Chart Y-Axis</p> <p>The LCSA command Autoscales the Chart Y-Axis. This command has no effect unless the chart display is on the screen. This command has no parameters and no query.</p> <p>Example</p> <p>LCSA Autoscale the Chart display.</p>
<hr/>	
LCRG (?) {n}	<p>Time Range</p> <p>The LCRG command sets (queries) the Chart X-Axis Time Range. The parameter n is a number of seconds ≥ 60.</p> <p>Examples</p> <p>LCRG? Returns the X-Axis Time Range in seconds.</p> <p>LCRG 600 Sets the X-Axis Time Range to 10 minutes (600 s).</p>

LCSF

Scale X-Axis to Full

The LCSF command Scales the X-Axis to Full. This sets Time Range to display all of the data in the log. This command has no effect unless the chart display is on the screen. This command has no parameters and no query.

Example

LCSF Set the X-Axis to the full log.

Mass Spectrum Display Commands

SCOK ?

Analog Scan OK

The SCOK? query returns 1 if the prerequisites for turning on the MassSpec Display exist. These include

- connection to RGA
- PPM100 and RGA operating normally with measurement enabled
- all process control channels in manual mode (active or inactive)
- filament emission on or RGA set to use an external ion source

If any of these conditions is not met, then SCOK? returns 0.

If SCOK? returns 1, then use the MENU5 command (below) to turn on the MassSpec Display. If SCOK? returns 0, then the MENU5 command will NOT turn on the MassSpec Display.

MENU (?) d

Display Screen

The MENU command changes (queries) the screen display. The parameter d selects a display listed below.

<u>d</u>	<u>display</u>	<u>d</u>	<u>display</u>
0	Pressure Display	4	Table Display
1	Monitor Display	5	MassSpec Display
2	Process Display	6	Analog I/O Display
3	Chart Display		

Use the MENU 5 command to show the MassSpec display and start analog RGA scanning.

Example

MENU 5 Shows the MassSpec Display on the screen.

SCMF (?) {n}

MassSpec Final Mass

The SSPM command sets (queries) the Final Mass for the MassSpec display analog scan. The parameter n is the mass in AMU, from 1 to the RGA max (100, 200 or 300). The default is 50.

Examples

SCMF? Returns the Final Mass.
 SCMF 100 Sets the Final Mass to 100 AMU.

SCMI (?) {n}

MassSpec Initial Mass

The SSTM command sets (queries) the Initial Mass for the MassSpec display analog scan. The parameter n is the mass in AMU, from 1 to the Final Mass-1. The default is 1.

Examples

SCMI? Returns the Initial Mass.
 SCMI 1 Sets the Initial Mass to 1 AMU.

SCAN (?) {i} **Analog Scan On/Off**

The SCAN 1 command starts analog scanning in the MassSpec display. Any current scan is aborted, the scan data is lost and a new scan is started.

The SCAN 0 command stops analog scanning in the MassSpec display. Current scan data is preserved until scanning is started again.

These commands have an effect *only* when the PPM100 is in the MassSpec display.

The SCAN? query returns 1 if a scan is in progress, 0 is not.

Example

SCAN 1	Start analog scanning (in MassSpec Display only).
SCAN?	Returns 1 if a scan is in progress.

OSCC ? **MassSpec Complete**

The OSCC? query returns 1 if a MassSpec has been completed (a complete Mass Spectrum is available) and 0 otherwise. Use the OSCC? query to determine whether mass spectrum data is available for all masses in the scan range before attempting to read the data.

Example

OSCC?	Returns 1 if a complete Mass Spectrum is available.
-------	---

LCPN (?) {x} **Chart/MassSpec Pmin**

The LCPN command sets (queries) the value of the Chart/MassSpec Y-Axis Pmin. The parameter x is a pressure expressed in the current units.

Examples

LCPN?	Returns the value of Pmin in the current pressure units.
LCPN 1.3e-10	Sets Pmin to 1.3×10^{-10} in the current units..

LCPX (?) {x} **Chart/MassSpec Pmax**

The LCPX command sets (queries) the value of the Chart/MassSpec Y-Axis Pmax. The parameter x is a pressure expressed in the current units.

Examples

LCPX?	Returns the value of Pmax in the current pressure units.
LCPX 1.3e-6	Sets Pmax to 1.3×10^{-6} in the current units.

SYSA **Autoscale MassSpec Y-Axis**

The SYSA command Autoscales the MassSpec Y-Axis. This command has no effect unless the MassSpec display is on the screen. This command has no parameters and no query.

Example

SYSA	Autoscale the Y-Axis in the MassSpec Display.
------	---

CTOM (?) {n}**Move MassSpec Cursor**

The CTOM command sets (queries) the cursor position for the MassSpec display analog scan. The parameter n is a mass in AMU (1-300).

Note

If the desired position is not within the current scan, the cursor will be placed at the edge of the display.

Example

CTOM? Returns the Cursor mass position.
CTOM 18 Sets the Cursor mass position to 18 AMU.

MACB ?**Read MassSpec Mass**

The MACB? query returns the exact location of the highest peak within a 1 AMU wide region centered on the cursor position (as set by the CTOM command).

Note

Use this command only if a MassSpec is complete (as indicated by the OSCC? query).

Example

MACB? Returns the exact mass position of the highest peak within ± 0.5 AMU of the cursor position.

PACB ?**Read MassSpec Peak**

The PACB? query returns the highest pressure within a 1 AMU wide region centered on the cursor position (as set by the CTOM command).

Note

Use this command only if a MassSpec is complete (as indicated by the OSCC? query).

Example

PACB? Returns the highest pressure within ± 0.5 AMU of the cursor position.

Process Control Commands

RDES (?) d {, s}	Channel Description <p>The RDES command sets (queries) the process channel Description string. The parameter d selects a process channel (1-8) and is required. The string s is the channel description.</p> <p>Examples</p> <p>RDES 3, pump Sets the Description of process channel 3 to "PUMP".</p> <p>RDES? 3 Returns the Description of channel 3 ("PUMP" in this case).</p>
RLCL (?) d {, s}	Channel Active Message <p>The RLCL command sets (queries) the process channel Active Message. The parameter d selects a process channel (1-8) and is required. The string s is the label.</p> <p>Examples</p> <p>RLCL 1, on Sets the Active Label of process channel 1 to "ON".</p> <p>RLCL? 1 Returns the Active Label of channel 1 ("ON" in this case).</p>
RLOP (?) d {, s}	Channel Inactive Message <p>The RLOP command sets (queries) the process channel Inactive Message. The parameter d selects a process channel (1-8) and is required. The string s is the label.</p> <p>Examples</p> <p>RLOP 1, off Sets the Inactive Label of process channel 1 to "OFF".</p> <p>RLOP? 1 Returns the Inactive Label of channel 1 ("OFF" in this case).</p>
RBEP (?) d {, i}	Channel Beep <p>The RBEP command sets (queries) whether the Beep (channel audio alert) is On (i=1) or Off (i=0). The parameter d selects a process channel (1-8) and is required.</p> <p>Examples</p> <p>RBEP? 1 Returns 1 if channel 1 Beep is on, 0 if off.</p> <p>RBEP 1, 1 Turns channel 1 Beep on.</p>
RMOD (?) d {, i}	Channel Mode <p>The RMOD command sets (queries) whether the mode of process channel d is Auto (i=1) or Manual (i=0). The parameter d selects a process channel (1-8) and is required. If the channel is Auto, its state is controlled by its process rules. If the channel is Manual, use the RSTA to set the channel state active or inactive.</p> <p>Examples</p> <p>RMOD? 2 Returns 1 if channel 2 is Auto, 0 if Manual.</p> <p>RMOD 2, 1 Sets channel 2 to Auto mode.</p>

RSTA (?) d {, i}

Channel State

The RSTA command sets (queries) the state of process channel d when its mode is Manual. The parameter d selects a process channel (1-8) and is required. The parameter i selects Inactive (0) or Active (1). This command requires that channel d is in Manual mode (RMOD command).

Examples

RSTA? 7 Returns 0 if channel 7 is Inactive, 1 if Active.
 RSTA 7, 0 Deactivates process control channel 7.

RAMS (?) d {, i}

Channel Input

The RAMS command sets (queries) the process control input (channel Linked To) for process channel d. The parameter d selects a process channel (1-8) and is required. The parameter i selects a control input below.

<u>i</u>	<u>input</u>	<u>i</u>	<u>input</u>	<u>i</u>	<u>input</u>
0	PP1	8	CM1	16	PPM alarm
1	PP2	9	CM2	17	Clock
2	PP3	10	CM3	18	TTL pin
3	PP4	11	CM4		
4	PP5	12	AN1		
5	PP6	13	AN2		
6	PP7	14	AN3		
7	PP8	15	AN4		

Examples

RAMS? 2 Returns the control input i for process channel 2.
 RAMS 2, 3 Sets the control input for channel 2 to PP4.

RGOS (?) d {, i}

Gauge Off State

The RGOS command sets (queries) the Gauge Off State for process channel d. The parameter d selects a process channel (1-8) and is required. The parameter i selects Inactive (0) or Active (1).

Examples

RGOS? 2 Returns 1 if channel 2 Gauge Off State is Active, 0 if Inactive.
 RGOS 2, 1 Sets channel 2 Gauge Off State to Active.

RTRP (?) d {, x}

Pressure Setpoint

The RTRP command sets (queries) the Pressure Setpoint for process channel d. The parameter d selects a process channel (1-8) and is required. The parameter x is the Pressure Setpoint expressed in the current units.

Examples

RTRP? 8 Returns the Pressure Setpoint for channel 8 in the current units.
 RTRP 8, 1.0e-3 Sets the Pressure Setpoint for channel 8 to 1.0×10^{-3} in the current units.

RTRV (?) d {, x}	Voltage Setpoint <p>The RTRV command sets (queries) the Voltage Setpoint for process channel d. The parameter d selects a process channel (1-8) and is required. The parameter x is the Voltage Setpoint in Volts.</p> <p>Examples</p> <p>RTRP? 8 Returns the Voltage Setpoint for channel 8 in Volts. RTRP 8, 5.2 Sets the Voltage Setpoint for channel 8 to 5.2 V.</p>
RPHY (?) d {, n}	Percent Hysteresis <p>The RPHY command sets (queries) the Percent Hysteresis for process channel d. The parameter d selects a process channel (1-8) and is required. The parameter n is the hysteresis percentage.</p> <p>Examples</p> <p>RPHY? 8 Returns the hysteresis percentage for channel 8. RPHY 8, 10 Sets the Setpoint Hysteresis for channel 8 to 10%.</p>
RVHY (?) d {, x}	Voltage Hysteresis <p>The RVHY command sets (queries) the Voltage Hysteresis for process channel d. The parameter d selects a process channel (1-8) and is required. The parameter x is the hysteresis voltage.</p> <p>Examples</p> <p>RVHY? 8 Returns the hysteresis percentage for channel 8. RVHY 8, 1.2 Sets the Voltage Hysteresis for channel 8 to 1.2V.</p>
RPOL (?) d {, i}	Setpoint Activation <p>The RPOL command sets (queries) the Setpoint Activation for process channel d. The parameter d selects a process channel (1-8) and is required. The parameter i selects Active Below (0) or Above (1).</p> <p>Examples</p> <p>RPOL? 6 Returns 1 if channel 6 is active Above, 0 if Below. RPOL 6, 1 Sets channel 6 to Active Above the setpoint.</p>
RDEL (?) d {, n}	Setpoint Delay <p>The RDEL command sets (queries) the Setpoint Delay for process channel d. The parameter d selects a process channel (1-8) and is required. The parameter n is the Delay in milliseconds.</p> <p>Note</p> <p>Times are stored in milliseconds, but this timer is only accurate to within a second.</p> <p>Examples</p> <p>RDEL? 5 Returns the Setpoint Delay of channel 5 in ms. RDEL 5, 10000 Sets Setpoint Delay of channel 5 to 10 seconds (10,000 ms).</p>

RTCL (?) d {,n} {,s} Activation Time

The RTCL command sets (queries) the Activation Time of day for process channel d. The parameter d selects a process channel (1-8) and is required. The parameter n is the time of day in milliseconds from midnight or the string s is the time in the format "9:30PM". Do not use both n and s in the command. The RTCL? query returns the value n in ms.

Examples

RTCL? 4 Returns the Activation Time of channel 5 in ms.
RTCL 4, 9:30pm Sets the Activation Time of channel 4 to 9:30 PM.
RTCL 4,77400000 Sets the Activation Time of channel 4 to 77,400,000 ms after midnight (9:30 PM).

RTOP (?) d {,n} {,s} Deactivation Time

The RTOP command sets (queries) the Deactivation Time of day for process channel d. The parameter d selects a process channel (1-8) and is required. The parameter n is the time of day in milliseconds from midnight or the string s is the time in the format "9:30PM". Do not use both n and s in the command. The RTOP? query returns the value n in ms.

Examples

RTOP? 4 Returns the Deactivation Time of channel 5 in ms.
RTOP 4, 9:30pm Sets the Deactivation Time of channel 4 to 9:30 PM.
RTOP 4,77400000 Sets the Deactivation Time of channel 4 to 77,400,000 ms after midnight (9:30 PM).

RTIL (?) d {, i} TTL Activation Level

The RTIL command sets (queries) the TTL Activation Level for process channel d. The parameter d selects a process channel (1-8) and is required. The parameter i selects Active when TTL input Low (0) or High (1).

Examples

RTIL? 3 Returns 1 if channel 3 is active when TTL Input High, 0 if Low.
RTIL 3, 1 Sets channel 3 to active when TTL Input High.

TLL ?**Read TTL Inputs**

The TLL? query returns the decimal value of a 24 bit binary number representing the state of the process control TTL Inputs as listed below.

Each bit is 0 if the input is TTL low, and 1 if the input is TTL high. All unused bits are 0.

<u>bit</u>	<u>description</u>
0	unused
1	unused
2	RGA_Degas_On
3	RGA_Fil_Lockout
4	RGA_Key_Disable
5	unused
6	unused
7	Clear_Data_Log
8	RGA_Remote_Enable
9	RGA_Fil_On
10	unused
11	RGA_TS_Disable
12	unused
13	unused
14	unused
15	unused
16	Process control TTL input #1
17	Process control TTL input #2
18	Process control TTL input #3
19	Process control TTL input #4
20	Process control TTL input #5
21	Process control TTL input #6
22	Process control TTL input #7
23	Process control TTL input #8

Example

If the returned value is 197136, the hex equivalent is 030210H indicating that all bits are low except bits 4, 9, 16 and 17.

RHGF ?**Read Process Log****RHGN ?**

The PPM100 logs all process control events. To read the process log, use the RHGF? query to return the most recent entry in the log. Then issue RHGN? repeatedly to get the rest of the entries, until the string "&" is returned, signaling that all entries have been read.

This command pair retrieves the log as it was when the RHGF? command was received. Log entries created while you download the log do not appear in it. If you try to retrieve history over two interfaces at the same time you will not get the complete history on either.

WARNING!

The Embedded Web Server continually issues RHGF and RHGN. If you have the web server option, you must disable it (from the Remote/Web menu or with the WSEN command) to use these commands.

The returned string has one of the formats below.

State or Mode change:

When a channel changes state or mode, an entry is returned with the following format.

```
"<date> <time> <StateBits (LSB first)> <ModeBits (LSB first)>
<channel #> <State or Mode> <new State or Mode>"
```

For example, the returned string

```
"23jun01 12:15:49 PM 10100000 01000000 #2 Mode Auto"
```

indicates the date/time that channel 2 was switched to Auto mode. The first bitfield shows 2 channels are active (1 and 3). The second bitfield shows that only channel 2 is in Auto mode.

Another example, the returned string

```
"23jun01 10:42:35 AM 10000000 00000000 #1 State Active"
```

indicates the date/time that channel 1 switched to the Active state. The first bitfield shows that only channel 1 is active. The second bitfield shows that no channels are in Auto mode.

Event format:

When an event occurs, an entry is returned with the following format.

```
"<date> <time> <event description>"
```

For example, the returned string

```
"22may01 04:36:25 PM Instrument turned on"
```

indicates the date/time that the unit was turned on.

RHCL

Clear Process Log

The RHCL command clears the Process Log. All entries in the Process Log are lost after sending the RHCL command.

Example

```
RHCL          Clear the Process Log immediately.
```

RBAD ?

Relay Failure Status

RBAD? query returns the decimal value of an 8 bit binary number representing the state of the process control relays. Bit 0 corresponds to Channel 1 and bit 7 corresponds to Channel 8. If the bit is 0, the relay is ok. If the bit is set, the relay is not trustworthy.

Example

```
RBAD?          Return the Relay Failure Status.
```

Backlight Commands

BLEN (?) {i}	<p>Backlight Saver Enable</p> <p>The BLEN command sets (queries) the Backlight Saver. The parameter i selects Disabled (0) or Enabled (1).</p> <p>Examples</p> <p>BLEN? Returns 1 if the Backlight Saver is Enabled, or 0 if Disabled.</p> <p>BLEN 1 Enables the Backlight Saver.</p>
---------------------	---

BLIT (?) {i}	<p>Backlight On/Off</p> <p>The BLIT command sets (queries) the state of the LCD screen backlight. The parameter i selects On (1) or Off (0).</p> <p>Examples</p> <p>BLIT? Returns 1 if the backlight is On, or 0 if Off.</p> <p>BLIT 1 Turns the screen backlight On.</p>
---------------------	---

BLOF (?) {n} {s}	<p>Backlight Turn-Off Time</p> <p>The BLOF command sets (queries) the Backlight Turn-Off Time of day. The parameter n is the time of day in milliseconds from midnight or the string s is the time in the format "9:30PM". Do not use both n and s in the command. The BLOF? query returns the value n in ms.</p> <p>Examples</p> <p>BLOF? Returns the Turn-Off Time in ms.</p> <p>BLOF 9:30pm Sets the Turn-Off Time to 9:30 PM.</p> <p>BLOF 77400000 Sets the Turn-Off Time to 77,400,000 ms after midnight (9:30PM).</p>
-------------------------	---

BLON (?) {n} {s}	<p>Backlight Turn-On Time</p> <p>The BLON command sets (queries) the Backlight Turn-On Time of day. The parameter n is the time of day in milliseconds from midnight or the string s is the time in the format "9:30PM". Do not use both n and s in the command. The BLON? query returns the value n in ms.</p> <p>Examples</p> <p>BLON? Returns the Turn-On Time in ms.</p> <p>BLON 9:30pm Sets the Turn-On Time to 9:30 PM.</p> <p>BLON 77400000 Sets the Turn-On Time to 77,400,000 ms (9:30PM).</p>
-------------------------	---

BLTD (?) {n}	<p>Backlight Delay</p> <p>The BLTD command sets (queries) the Backlight Saver Delay. The parameter n is the Delay in milliseconds.</p> <p>Examples</p> <p>BLTD? Returns the Backlight Saver Delay in ms.</p> <p>BLTD 300000 Sets Delay to 5 minutes (300,000 ms).</p>
---------------------	---

System Commands

NAME (?) {s}

System Name

The NAME command sets (queries) the System Name. The string s is the name and is converted to UPPER case.

Examples

NAME? Returns the System Name.
NAME my PPM Sets the Name to "MY PPM".

TIME (?) {s}

Time

The TIME command sets (queries) the System Time of day. The string s is the time in the format "9:30PM" or "17:30"

Examples

TIME 9:30pm Sets the system time to 9:30 PM.
TIME 21:30 Sets the system time to 9:30 PM.
TIME? Returns "21:30".

DATE (?) {s}

Date

The DATE command sets (queries) the System Date. The string s is the date in the format "ddMMMyy" where "MMM" are the first 3 letters of the month (jan, feb, mar, etc.).

Examples

DATE 23may01 Sets the system date to May 23, 2001.
DATE? Returns "23may01".

VOLC (?) {n}

Volume

The VOLC command sets (queries) the system audio Volume. The parameter n is the volume setting from 0 to 10.

Examples

VOLC? Returns the Volume setting.
VOLC 9 Sets the Volume to 9 (loud).

MENU d

Display Screen

The MENU command changes (queries) the screen display. The parameter d selects a display listed below.

<u>d</u>	<u>display</u>	<u>d</u>	<u>display</u>
0	Pressure Display	4	Table Display
1	Monitor Display	5	MassSpec Display
2	Process Display	6	Analog I/O Display
3	Chart Display		

Note

Use the SCOK? query before using MENU 5 to switch to the MassSpec Display.

Example

MENU 2 Shows the Process Display on the screen.

MESG (?) {s}**Message**

The MESG s command sends the message string s to the screen. The message is cleared after about 10 seconds or may be cleared from the front panel sooner.

The MESG? query returns 1 if the message has not been cleared and 0 if it has been cleared.

Examples

MESG warning Displays the message "WARNING" on the screen.

MESG? Returns 1 until the message has been cleared and then 0.

DHWR ? d**Detect Hardware**

The DHWR? d command returns 1 if component d (listed below) is present, 0 if not installed. This is a query only command.

<u>d</u>	<u>component</u>	<u>d</u>	<u>component</u>
3	Process control	11	USB port
4	RS232 interface	13	Web server
10	IEEE488 (GPIB) interface		

Example

DHWR? 13 Returns 1 if the Web server is installed.

TST ?*Self-Test**

The *TST ? query performs a self-test and returns 0 if the test passes.

Returned values which are warnings are listed below.

<u>value</u>	<u>description</u>
0	Test pass
1	Unable to perform all tests
2	Excess load on Aux ± 15 V supply
3	Relay failure
4	Communication port problem
5	RGA comm port problem
6	RS232 comm port problem
7	USB comm port problem
8	GPIB comm port problem
9	web port problem
10	calibration checksum failed

If *TST ? returns any other value, reboot the PPM100 by cycling its power (be sure that all process channels are unconnected). If the problem persists, contact Stanford Research Systems for further instructions.

FREV ?**Firmware Revision**

The FREV? query returns the PPM100 firmware revision code.

VRDT ?**Firmware Build**

The VRDT? query returns the date of the PPM100 firmware revision.

SNUM ?**Serial Number**

The SNUM? query returns the unit serial number.

Interface Commands

VERB (?) {i}

Verbose RS-232

The VERB command sets (queries) the verbose serial communication mode. The parameter *i* selects Verbose (1) or Terse (0). This command only affects the RS-232 interface. The GPIB interface is always in Terse mode.

Use Terse for programming. All responses to queries are as documented in this chapter. **Use the Verb 0 command at the start of all programs.**

Use Verbose for terminal applications or debugging. All terse responses are followed with a verbose message which explains the response.

For example, a query might return "0" (terse) or "0 off" (verbose).

Examples

VERB?	Returns 1 if verbose mode, 0 if terse mode.
VERB 0	Use terse responses.

*IDN ?

Identification

The *IDN ? query returns the PPM100's device identification string. This string is in the format "Stanford_Research_Systems,PPM100,s/n0,ver001". In this example, the serial number is 0 and the firmware version is 001.

*RST

Reset

The *RST command resets the PPM100 to its default configurations. The communications setup is not changed. All other modes and settings are set to their default conditions and values. This command takes some time to complete.

Do not send other commands on the same command line after *RST. Do not send another command until *RST is complete. This takes about 10 seconds. You can send a query command (like *OPC?) and wait for the response. When the response comes, the unit is ready.

WSEN (?) {i}

Web Server Enable

The WSEN command sets (queries) whether the Web Server Option is Enabled (*i*=1) or Disabled (*i*=0). Disable the web server to prevent web users from interfering with local computer control. It may take up to 10 seconds for this to take effect.

Example

WSEN?	Returns 1 if web server is Enabled, 0 if Disabled.
WSEN 0	Disables the web server option.

Status Reporting

The PPM100 reports on its status by means of five status registers: the Serial Poll, Standard Event, Error, Gauge and Process Control status registers.

Status Registers

In the PPM100, a status register is a read-only, 16 bit word where the state of each bit indicates a specific instrument state or condition.

Bits in status registers are set when their corresponding condition or status is met. *Except for the Serial Poll status bits*, once a status bit is set, it remains set until cleared by a read with the appropriate status reporting command. *Whenever a status bit is set, it remains set until read.*

Some status bits report that a bit is set in another status register.

Resetting the PPM100, turning it off, or issuing *RST do not clear the status registers. Reading the status registers or issuing *CLS clears the status registers. Powering-up with *PSC enabled also clears the status registers.

This instrument extends the IEEE-488 specification by allowing you to check and clear individual bits in a status register.

Status Enable Registers

Status enable registers let you decide which conditions you care about and check them all with one *STB? query or GPIB serial poll.

The Standard Event, Error, Gauge and Process status registers all have a corresponding status enable register. Each bit in the enable register matches with a bit in the corresponding status register. Bits in the enable registers are set with the status enable commands. The enable bits do not affect the value of the status register and are not affected by status reads.

When a bit in *BOTH* a status register *AND* its enable register are set, then a bit in the Serial Poll Status register will become set. This mechanism reports underlying status conditions to a single status register (Serial Poll Status).

Serial Poll Status Register

The Serial Poll Status register is a special status register. It is a single byte (8 bits) and contains bits corresponding to the other four status registers. When a status bit (in another status register) *and* the matching enable bit (in its corresponding enable register) are *both* set, a bit is set in the Serial Poll Status register. This allows a single read of the Serial Poll Status to determine if any enabled bits in *all* of the other status registers is set. These bits in the Serial Poll Status *are not* cleared by reading. They remain set as long as the enabled bit in the other status register is set. Read the other status registers to determine which bit(s) are set and clear them.

The Serial Poll Status register has a matching Serial Poll Enable register. When a bit in *both* becomes set, the Service Request, or SRQ, bit will be set. This causes an IEEE-488 bus service request. When an enabled Serial Poll bit becomes set, a single service request is generated.

***STB? to Read the Serial Pol Status**

The Serial Poll Status register is *NOT* cleared by reading the status using *STB?. A bit stays set as long as the status condition exists. This is true even for bit 6 (SRQ). Bit 6 will be set whenever the same bit in the Serial Poll Status *AND* Serial Poll Enable registers is set.

Serial Poll to Read the Status

Except for SRQ, a bit in the Serial Poll Status is *NOT* cleared by GPIB serial polling the status register. A bit stays set as long as the status condition exists.

When reading the status using a GPIB serial poll, the SRQ bit signals that the PPM100 is requesting service. The SRQ bit will be set the *first* time the PPM100 is polled following a service request. The serial poll automatically clears the service request. Subsequent serial polls will return SRQ cleared until another service request occurs. Polling the status word and reading it with *STB? can return different values for SRQ. When serial polled, SRQ indicates a service request has occurred. When read with *STB?, SRQ indicates that an enabled Serial Poll Status bit is set.

Service Request

A GPIB service request (SRQ) will be generated whenever a bit in both the Serial Poll Status register *AND* Serial Poll Enable register is set. Use *SRE to set bits in the Serial Poll Enable register.

A service request is only generated when an enabled Serial Poll Status bit becomes set (changes from 0 to 1). An enabled status bit which becomes set and remains set will generate a single SRQ. This prevents a single, persistent condition, such as overload, from generating an endless stream of service requests.

If another service request from the same status bit is desired, the requesting status bit must first be cleared. In the case of the PCSQ, GERR, IERR and ESB bits, this means clearing the enabled bits in the Process, Gauge, Error or Standard Event Status registers (by reading them) or clearing the appropriate bits in the corresponding enable registers. Multiple enabled bits in these status registers will generate a single SRQ. Another SRQ (from PCSQ, GERR, IERR or ESB) can only be generated after clearing the PCSQ, GERR, IERR or ESB bits in the Serial Poll Status.

The controller should respond to the SRQ by performing a serial poll to read the Serial Poll Status to determine the requesting status bit. Bit 6 (SRQ) will be reset by the serial poll. The controller should then investigate the appropriate status register to find the requesting status bit. The SRQ handler should deal with the actual problem (e.g. removing an overload condition), *NOT* just clear the bit and continue. This can lead to repeated SRQ events.

Power-On Status

Powering on does not clear the status registers. Reading status registers or issuing *CLS clears status registers.

Upon power-on, the PPM100 may either clear all of its status *enable* registers or maintain them as they were on power-off. The *PSC command determines which action will be taken.

Status Reporting Commands

*CLS	<p>Clear Status</p> <p>The *CLS command clears all status registers. The enable registers are <i>not</i> changed.</p>
-------------	--

*PSC (?) {i}	<p>Power-On Status Clear</p> <p>The *PSC command sets the value of the power-on status clear bit.</p> <p>If i=1 the power-on status clear bit is set and all status registers and enable registers are cleared on power up.</p> <p>If i=0 the bit is cleared and all enable registers are stored at power down. The status registers are cleared and the enable registers are restored to their stored values on power up. This allows a service request to be generated at power up. The default value is 0.</p>
---------------------	--

*STB ? {i}	<p>Read Serial Poll Status</p> <p>The *STB? query returns the value of the Serial Poll Status register. The value is returned as a decimal number from 0 to 255. The *STB? i query returns the value (0 or 1) of bit i (0-7). The conditions for each bit are listed below.</p> <table border="0"> <thead> <tr> <th style="text-align: left;"><u>bit</u></th> <th style="text-align: left;"><u>name</u></th> <th style="text-align: left;"><u>set when</u></th> </tr> </thead> <tbody> <tr> <td>0</td> <td>PCSQ</td> <td>An enabled bit in the Process Control Status is set.</td> </tr> <tr> <td>1</td> <td>IERR</td> <td>An enabled bit in the Error Status is set.</td> </tr> <tr> <td>2</td> <td>GERR</td> <td>An enabled bit in the Gauge Status is set.</td> </tr> <tr> <td>3</td> <td>RCC</td> <td>PPM100 has no pending commands for the RGA.</td> </tr> <tr> <td>4</td> <td>MAV</td> <td>Data is available in the GPIB output buffer.</td> </tr> <tr> <td>5</td> <td>ESB</td> <td>An enabled bit in the Event Status is set.</td> </tr> <tr> <td>6</td> <td>SRQ</td> <td>Service request occurs.</td> </tr> <tr> <td>7</td> <td>IFC</td> <td>No PPM100 Command Execution is in progress.</td> </tr> </tbody> </table> <p>The value of bit 6 (SRQ) when read using *STB? returns 1 if a bit is set in BOTH the Serial Poll Status register AND the Serial Poll Enable register. This is independent of serial polling and GPIB service requests. Bit 6 is the SRQ bit only when serial polled.</p> <p>*STB? has no effect on the value of the Serial Poll Status register. To clear a bit in the Serial Poll Status, the condition which causes it to be set must be cleared. For the PCSQ, GERR, IERR or ESB bits, this is accomplished by clearing the enabled status bits in the Process, Gauge, Error or Standard Event status words (by reading them).</p> <p>Examples</p> <table border="0"> <tr> <td>*STB?</td> <td>Returns the Serial Poll Status register (0-255).</td> </tr> <tr> <td>*STB? 2</td> <td>Returns 0 if bit 2 (GERR) is clear, 1 if it is set.</td> </tr> </table>	<u>bit</u>	<u>name</u>	<u>set when</u>	0	PCSQ	An enabled bit in the Process Control Status is set.	1	IERR	An enabled bit in the Error Status is set.	2	GERR	An enabled bit in the Gauge Status is set.	3	RCC	PPM100 has no pending commands for the RGA.	4	MAV	Data is available in the GPIB output buffer.	5	ESB	An enabled bit in the Event Status is set.	6	SRQ	Service request occurs.	7	IFC	No PPM100 Command Execution is in progress.	*STB?	Returns the Serial Poll Status register (0-255).	*STB? 2	Returns 0 if bit 2 (GERR) is clear, 1 if it is set.
<u>bit</u>	<u>name</u>	<u>set when</u>																														
0	PCSQ	An enabled bit in the Process Control Status is set.																														
1	IERR	An enabled bit in the Error Status is set.																														
2	GERR	An enabled bit in the Gauge Status is set.																														
3	RCC	PPM100 has no pending commands for the RGA.																														
4	MAV	Data is available in the GPIB output buffer.																														
5	ESB	An enabled bit in the Event Status is set.																														
6	SRQ	Service request occurs.																														
7	IFC	No PPM100 Command Execution is in progress.																														
*STB?	Returns the Serial Poll Status register (0-255).																															
*STB? 2	Returns 0 if bit 2 (GERR) is clear, 1 if it is set.																															

***SRE ? {i} {, j}**

Serial Poll Enable

The *SRE i command sets the Serial Poll Enable register to the decimal value i (0-255). The *SRE i, j command sets bit i (0-7) to j (0 or 1).

The *SRE? query returns the value (0-255) of the Serial Poll Enable register. The *SRE? i query returns the value (0 or 1) of bit i (0-7).

When a bit becomes set in BOTH the Serial Poll Status register AND the Serial Poll Enable register, an SRQ (GPIB service request) is generated. The SRQ is cleared by performing a serial poll. The bit in the Serial Poll Status which caused the SRQ must be cleared before this bit can cause another SRQ. To clear this bit, the condition which causes it to be set in the Serial Poll Status needs to be cleared. For the PCSQ, GERR, IERR or ESB bits, this is accomplished by clearing the enabled status bits in the Process, Gauge, Error or Standard Event status words (by reading them).

Examples

- *SRE? Returns the Serial Poll Enable register (0-255).
- *SRE? 2 Returns 0 if bit 2 is clear, 1 if it is set.
- *SRE 40 Sets the Serial Poll Enable register to 40 decimal (bits 3 and 5 set).
- *SRE 1, 0 Clears bit 1 of the Serial Poll Enable register.

***ESR ? {i}**

Read Standard Event Status

The *ESR? query returns the value of the Standard Event Status register. The value is returned as a decimal number from 0 to 255. The *ESR? i query returns the value (0 or 1) of bit i (0-7).

*ESR? clears the entire register while *ESR? i clears just bit i.

The conditions for each bit are listed below.

<u>bit</u>	<u>name</u>	<u>set when</u>
0	OPC	The *OPC command completes.
1	Unused	
2	Unused	
3	Unused	
4	EXE	A command cannot be executed.
5	CME	A command syntax error occurs.
6	Unused	
7	PON	Unit turns on.

The Standard Event Status is defined by IEEE-488.2 (1987) and is used primarily to report errors in commands received over the interface. These bits remain set until read, cleared by *CLS or power-up with *PSC enabled.

Examples

- *ESR? Returns the Standard Event Status register (0-255).
- *ESR? 5 Returns 0 if bit 5 (CME) is clear, 1 if it is set.

***ESE (?) {i} {, j}**

Standard Event Enable

The *ESE i command sets the Standard Event Enable register to the decimal value i (0-255). The *ESE i, j command sets bit i (0-7) to j (0 or 1).

The *ESE? query returns the value (0-255) of the Standard Event Enable register. The *ESE? i command queries the value (0 or 1) of bit i (0-7).

When a bit becomes set in BOTH the Standard Event Status register AND the Standard Event Enable register, bit 5 (ESB) of the Serial Poll Status is set. This causes an SRQ if bit 5 in the Serial Poll Enable register is set. To clear a bit in the Standard Event Status, use *ESR?.

Examples

- *ESE? Returns the Standard Event Enable register (0-255).
- *ESE? 2 Returns 0 if bit 2 is clear, 1 if it is set.
- *ESE 48 Sets the Standard Event Enable register to 48 decimal (bits 4 and 5 set).
- *ESE 7, 0 Clears bit 7 of the Standard Event Enable register.

ERSW ? {i}

Read Error Status

The ERSW? query returns the value of the Error Status register. The value is returned as a decimal number from 0 to 65535. The ERSW? i query returns the value (0 or 1) of bit i (0-15).

ERSW? clears the entire register while ERSW? i clears just bit i.

The conditions for each bit are listed below.

<u>bit</u>	<u>name</u>	<u>set when</u>
0	Tst_Err	Selftest fails.
1	Math_Err	An internal math error occurs.
2	RAM_Err	The RAM checksum fails.
3	ROM_Err	The ROM checksum fails.
4	Batt_Err	Data in battery backed-up RAM was lost.
5	Stk_Err	An internal stack error occurs.
6	Heap_Err	An internal heap error occurs.
7	Rly_Err	A process control relay failure is detected.
8	Com_Err	An error with a communications port occurs.
9	Mnt_Err	A selftest requests routine maintenance.
10	Unused	
11	Unused	
12	Unused	
13	Reset_Err	A Watchdog timer reset has occurred.
14-15	Unused	

These bits **REMAIN SET** until read, cleared by *CLS or power-up with *PSC enabled.

Examples

- ERSW? Returns the Error Status register (0-65535).
- ERSW? 8 Returns 0 if bit 8 (Com_Err) is clear, 1 if it is set.

ERSE (?) {i} {, j}

Error Status Enable

The ERSE i command sets the Error Status Enable register to the decimal value i (0-65535). The ERSE i, j command sets bit i (0-15) to j (0 or 1).

The ERSE? query returns the value (0-65535) of the Error Status Enable register. The ERSE? i query returns the value (0 or 1) of bit i (0-15).

When a bit becomes set in BOTH the Error Status register AND the Error Status Enable register, bit 1 (IERR) of the Serial Poll Status is set. This causes an SRQ if bit 1 in the Serial Poll Enable register is set. To clear a bit in the Error Status, use ERSW?.

Examples

- ERSE? Returns the Error Status Enable register (0-65535).
- ERSE? 2 Returns 0 if bit 2 is clear, 1 if it is set.
- ERSE 48 Sets the Error Status Enable register to 48 decimal (bits 4 and 5 set).
- ERSE 12, 0 Clears bit 12 of the Error Status Enable register.

GSSW ? {i}

Read Gauge Status

The GSSW? query returns the value of the Gauge Status register. The value is returned as a decimal number from 0 to 65535. The GSSW? i query returns the value (0 or 1) of bit i (0-15).

GSSW? clears the entire register while GSSW? i clears just bit i.

The conditions for each bit are listed below.

<u>bit</u>	<u>name</u>	<u>set when</u>
0	RGA_Com	a problem communicating with the RGA head occurs. This includes the RGA being turned off or disconnected.
1	Unused	
2	Unused	
3	Unused	
4	AN1_Rng	AN1 reading is out-of-range.
5	AN2_Rng	AN2 reading is out-of-range.
6	AN3_Rng	AN3 reading is out-of-range.
7	AN4_Rng	AN4 reading is out-of-range.
8-13	Unused	
14	Scan_Done	an analog scan in the MassSpec display completes.
15	Log_Entry	a new point is added to the pressure log.

These bits **REMAIN SET** until read, cleared by *CLS or power-up with *PSC enabled. For example, if AN1 is out-of-range, bit 4 will become set. Reading this status register will clear the bit. However, if AN1 remains out-of-range, then bit 4 will become set again (within 0.5 second). This can lead to repeated SRQs if the appropriate enable bits are set. In this case, the SRQ handler should not just read the status to clear the bit but also deal with the actual cause, in this case, why is the signal at AN1 out of range?, and remove the source of the problem.

Examples

- GSSW? Returns the Gauge Status register (0-65535).
- GSSW? 14 Returns 0 if bit 14 (Scan_Done) is clear, 1 if it is set.

GSSE (?) {i} {, j}

Gauge Status Enable

The GSSE i command sets the Gauge Status Enable register to the decimal value i (0-65535). The GSSE i, j command sets bit i (0-15) to j (0 or 1).

The GSSE? query returns the value (0-65535) of the Gauge Status Enable register. The GSSE? i query returns the value (0 or 1) of bit i (0-15).

When a bit becomes set in BOTH the Gauge Status register AND the Gauge Status Enable register, bit 2 (GERR) of the Serial Poll Status is set. This causes an SRQ if bit 2 in the Serial Poll Enable register is set. To clear a bit in the Gauge Status, use GSSW?.

Examples

- GSSE? Returns the Gauge Status Enable register (0-65535).
- GSSE? 15 Returns 0 if bit 15 is clear, 1 if it is set.
- GSSE 48 Sets the Gauge Enable register to 48 decimal (bits 4, 5 set).
- GSSE 14, 0 Clears bit 14 of the Gauge Status Enable register.

RSSW ? {i}

Read Process Status

The RSSW? query returns the value of the Process Status register. The value is returned as a decimal number from 0 to 65535. The RSSW? i query returns the value (0 or 1) of bit i (0-15).

RSSW? clears the entire register while RSSW? i clears just bit i.

The conditions for each bit are listed below.

<u>bit</u>	<u>name</u>	<u>set when</u>
0	Ch1_Chg	Process control channel 1 changes state.
1	Ch2_Chg	Process control channel 2 changes state.
2	Ch3_Chg	Process control channel 3 changes state.
3	Ch4_Chg	Process control channel 4 changes state.
4	Ch5_Chg	Process control channel 5 changes state.
5	Ch6_Chg	Process control channel 6 changes state.
6	Ch7_Chg	Process control channel 7 changes state.
7	Ch8_Chg	Process control channel 8 changes state.
8	Ch1_Act	Process control channel 1 is active.
9	Ch2_Act	Process control channel 2 is active.
10	Ch3_Act	Process control channel 3 is active.
11	Ch4_Act	Process control channel 4 is active.
12	Ch5_Act	Process control channel 5 is active.
13	Ch6_Act	Process control channel 6 is active.
14	Ch7_Act	Process control channel 7 is active.
15	Ch8_Act	Process control channel 8 is active.

The Process Control Status reflects the current process control state and indicates channels that have changed state (1 or more times) since the last time the status was read.

The lower 8 bits are set when a channel changes state and **REMAIN SET** until read, *CLS executes, or power-on with *PSC enabled. These bits can be enabled

to generate an SRQ. Reading this register will clear these bits and they will remain cleared until the relay changes state again.

The upper 8 bits always reflect the state of the process control channels **at the time this status is read**. These bits should **NOT** be enabled to generate an SRQ. Reading this register will clear these bits but if the relay remains active, the bit will immediately be reset and generate another SRQ.

Examples

RSSW? Returns the Process Control Status register (0-65535).
 RSSW? 10 Returns 0 if bit 10 (Ch3_Act) is clear, 1 if it is set.

RSSE (?) {i} {, j}

Process Status Enable

The RSSE i command sets the Process Status Enable register to the decimal value i (0-65535). The RSSE i, j command sets bit i (0-15) to j (0 or 1).

The RSSE? query returns the value (0-65535) of the Process Status Enable register. The RSSE? i query returns the value (0 or 1) of bit i (0-15).

When a bit becomes set in BOTH the Process Status register AND the Process Status Enable register, bit 0 (PCSQ) of the Serial Poll Status is set. This causes an SRQ if bit 0 in the Serial Poll Enable register is set. To clear a bit in the Process Status, use RSSW?.

Examples

RSSE? Returns the Process Status Enable register (0-65535).
 RSSE? 2 Returns 0 if bit 2 is clear, 1 if it is set.
 RSSE 48 Sets the Process Status Enable register to 48 decimal (bits 4 and 5 set).
 RSSE 12, 0 Clears bit 12 of the Process Status Enable register.

Using USB

Introduction

Remote control of the PPM using USB requires:

- An OS that supports USB (Windows 2000, XP, 98, Mac OS 8 or OS 9, Linux).
- Application software (your own Labview, C++, etc. program or a terminal emulator such as HyperTerm) that can access a COM port.
- USB driver for your OS.
- USB hardware on your computer.
- A USB cable.

SRS supplies the Virtual COM Port (VCP) driver from FTDI (ftdi.com) for Windows and Mac OS. Once installed, VCP makes an attached USB device appear as if it were connected via a normal serial port (COM port). Programmatic control is possible in Windows using LabView, the Windows VCOMM API, or a 3rd party COM library. RealBasic and LabView can be used on a Mac.

The baud rate, start, stop, and parity are ignored by VCP. The port number (COM1, COM2, etc) can be manually set in the VCD driver page of the Windows device manager. Linux users should follow the link from the FTDI Driver Download page for Linux drivers.

Windows 2000, XP, and 98

Installing VCP (Virtual Com Port [without PNP support])

- Download the Windows driver set from <http://www.thinkSRS.com> (remember where you put it).
- Unzip it into a temporary directory.
- If the FTDI driver is already installed, uninstall it using Uninstal.exe.
- Plug the PPM100 into the PC USB port and turn the unit on. Windows will prompt, “a new device has been found” and “Building Driver Information Database” followed by the Add New Hardware Wizard. If Windows asks to search for the driver, click OK.
- Windows should find the file that you just unzipped. If not, navigate to the correct directory. Select Next.
- To confirm that the installation has completed successfully look under Device Manager of the System Properties screen. The device should have installed as a USB Serial Port (COMx) attached to USB High Speed Serial Converter.

Testing

It's a good idea to test the COM port installation before attempting to write a program to communicate with your PPM100.

- Open Hyperterminal from the Start Menu:
Programs/Accessories/Communications/Hyperterminal
- Enter a name (e.g. PPM on COM5) at the New Connection dialog.
- Choose the COM port that VCP installed to in the Connect To dialog.
- Ignore the COMx settings page – just click OK.

If the PPM is connected and turned on, you should be able to type in *IDN? <Enter> and get the instrument identification string in response. You can modify the terminal settings to improve the readability of your session as follows:

- Select Call/Disconnect from the Hyperterminal menu.
- Select File/Properties and click on the Settings Page tab.
- Click on ASCII setup and check the “Echo typed characters locally” and “append line feeds to incoming line ends” boxes.
- Click OK and OK again to finish the Properties dialog.
- Select File/Save to save your HyperTerminal configuration for later use.

This HyperTerminal setup will allow you to try out the PPM commands before you include them in your program. However, only one application can be connected to a COM port at a time. If HyperTerminal is running, your program will fail to open the COM port. Likewise, HyperTerminal will not be able to use the COM port if your program is running.

VCP Options : COM port number

Some Applications (e.g. HyperTerminal) can only use COM ports within a certain range (e.g. COM1 through COM4). If this is the case, you may want to manually select the COM port number that VCP uses. To change the virtual COM port properties

- Open the Device Manager
- Select the USB Serial Port
- Click Properties.
- Select Port Settings.
- Select Advanced.
- Click the drop down arrow on COM Port Number and scroll to the required COM port.
- Select OK.

Be sure not to select a COM port which is already in use. When you return to the Device Manager Screen you will see that the USB Serial Port installation has been changed to the desired COM number.

Mac OS8 and OS9

Installing USBSerial extension

- Download the mac drivers from <http://www.thinkSRS.com>
- Unstuff it.
- Drag it into the System/Extensions folder.
- Reboot.
- Open AppleWorks and Open a new Comm Module.
- Select USBSerial (instead of modem)
- Begin a session and check “echo locally” and “carriage return on line feed”

If the PPM is connected and turned on, you should be able to type in *IDN? <Enter> and get the instrument identification string in response.

Chapter 7

Embedded Web Server (EWS)

The embedded web server (EWS) provides an ethernet connection between the PPM100 and a network. The EWS allows monitoring and control of the PPM100 from a local network or the world wide web.

The EWS allows you to

- Monitor and control the PPM100 from virtually anywhere in the world.
- View vacuum system data using a standard web browser.
- Get log data from the PPM100 without writing a custom program.

In This Chapter

EWS Quick Start	7-3	Using the EWS	7-18
Connect the PPM100 to Your Network	7-3	Bookmarking the PPM100	7-19
Set the Network Addresses	7-3	Monitoring the PPM100	7-19
Set the Security Level	7-3	Get Readings	7-19
Enable the EWS	7-3	Show Stored Plot	7-19
Access the Web Page	7-4	Auto Monitor	7-20
Installing the EWS	7-5	Process History	7-21
Network Administration Concerns	7-5	Get Datalog	7-22
Static IP	7-5	Get Userlog	7-23
Port Number	7-6	Email Status	7-23
Setting Network Addresses	7-6	Controlling the PPM100	7-24
Enable the EWS	7-7	Request Control	7-24
System Name	7-7	Release Control	7-24
MAC Address	7-8	Get Chart Type	7-24
Choosing a Network Configuration	7-9	MassSpec Display and Analog Scanning	7-25
Crossover Cable Configuration	7-9	Email Notices	7-28
Internal LAN Configuration	7-10	Change Relays	7-31
Conventional LAN Configuration	7-11	Networking Terms	7-32
Outside Firewall Configuration	7-12		
Testing with a Crossover Cable	7-13		
Testing Within a Network	7-14		
Configuring EWS Security	7-15		
Web Server Enable	7-15		
Web Control Enable	7-15		
Security Type	7-16		
IP Checking	7-16		
IP and Password Checking	7-16		
Password Checking Only	7-17		

EWS Quick Start

If you are comfortable with networking and wish to get your EWS up and going as quickly as possible, use the Quick Start instructions here. Please read the rest of this chapter for a more complete description of the EWS features and capabilities.

Connect the PPM100 to Your Network

Warning!

- Connecting your vacuum system to the world-wide-web can expose it to unauthorized access, resulting in harm to personnel as well as equipment.
- Network security is a serious matter. Consult your network administrator for more information about using web-enabled instruments in your lab.

Use a CAT5 ethernet cable to connect your hub or switch to the ethernet connector on the back of the PPM100 (with EWS installed). *Do not use a crossover cable.*

Bring up the Web setup menu by pressing the [Menu] QuickKey (in the Pressure Display), choosing [Remote] and then [Web].

Set the Network Addresses

For full use of the EWS, you will need a static IP (Internet Protocol) address, subnet mask, DNS (Domain Name Server) address, and gateway address. See your network administrator to obtain addresses appropriate for your network environment. If you already know the IP address you will be using, you may be able to find your subnet mask and gateway by typing "ipconfig" from your workstation's command line prompt.

Enter these values in the Main/Remote/Web menu of the PPM100.

Set the Security Level

To quickly allow access to all EWS features, go to the Main/Remote/Web/Control submenu and set Web Control to Enabled and Security Type to Password. The default password is "PPM100".

Read the section 'Configuring EWS Security' later in this chapter for a complete description of EWS security features.

Enable the EWS

Return to Main/Remote/Web and set Web Server to Enabled. Your EWS stores the network addresses into non-volatile memory, then gathers data on your PPM100 setup (gauge and relay descriptions, etc.). Allow the EWS about 30 seconds before continuing.

To make sure the EWS is functioning, touch the [Web Queue] button. If commands are streaming across the display, the EWS is communicating with the PPM100.

Access the Web Page

Start your web browser and in the location (URL) bar, type the IP address you assigned to the EWS. Make sure JavaScript is not disabled in your browser. You should see a web page similar to below.

PPM100 - Microsoft Internet Explorer

File Edit View Favorites Tools Help

SRS

Web-Enabled PPM100
Name: SRS PPM100

Functions

Monitor

Get Readings

Show Stored Plot

Auto Monitor

Get Userlog

Process History

Email Status

Get Datalog

Pressures

A/D Voltages

Relay States

TTL Levels

Get Web Output

Get CSV Output

Control

Request Control

Get Chart Type

Function : MONITOR

Last Reading : 15jul03 at 13:31

Gauges

Gauge	Reading	Name
PP1	1.68-07 Torr	Hydrogen
PP2	5.31-09 Torr	Helium
PP3	2.71-07 Torr	Water
PP4	2.44-06 Torr	Nitrogen
PP5	4.87-07 Torr	Oxygen
PP6	4.05-08 Torr	Argon
PP7	8.10-09 Torr	Pump oil
PP8	1.21-07 Torr	CO2
AN1	+6.822 V	FLOW CONTROLLER
AN2	+5.319 V	PULSED VALVE
AN3	-0.212 V	HEATING JACKET
AN4	+7.984 V	THROTTLING VALVE

Relay Status

Channel	1	2	3	4
Description	GATE VALVE	HEAT JACKET	TURBO PWR	WATER LINES
Current State	INACTIVE	INACTIVE	INACTIVE	INACTIVE
	MANUAL	MANUAL	MANUAL	MANUAL

Channel	5	6	7	8
Description	DETECTOR	DIFF PUMP PWR	PULSED VALVE	MECH PUMPS
Current State	INACTIVE	INACTIVE	INACTIVE	INACTIVE
	MANUAL	MANUAL	MANUAL	MANUAL

Running on a Xesem Web Controller

Figure 7-1. EWS web page.

Installing the EWS

This section covers the network installation and configuration of the Embedded Web Server. While this adds powerful functionality to the PPM100, *connecting your vacuum system to the world-wide-web can expose it to unauthorized access, resulting in harm to personnel as well as equipment.*

Warning!

Network security is a serious matter. Consult your network administrator for more information about using web-enabled instruments in your lab.

Network Administration Concerns

Your network administrator has a difficult job. In addition to making sure your network is always running smoothly, she also needs to keep track of which IP addresses are assigned to which machines. This prevents IP address collisions (where more than one computer has the same IP address), as well as maintains the security of the network.

Your administrator may have a limited number of free IP addresses, and may show concern about having an instrument on the network in the first place.

Some of the first questions she may ask include:

- Why does an instrument need an IP address?
- Why does it need a static IP address?
- What happens if everyone in the department wants instruments with IP addresses?
- What is the MAC address for this instrument?
- What kind of security measures are in place?

These are all very valid concerns. You will need to explain what you want to do, and allow your administrator enough leeway to accomplish your goals while still satisfying hers. Some of the information in this chapter may help you both.

Static IP

The reason your instrument needs a static IP address is because it is a *server*. You need your server to be at the *same* address all the time, so you always know where to point your browser. It is likely that once your instrument is running, it will remain on 24 hours a day, 7 days a week. This makes using a dynamic IP address (one that changes with each power up sequence) somewhat infeasible. Note that the EWS does not use a conventional file system; data is generated on the fly for dynamic pages and static pages are stored in flash memory. This makes the server less prone to common security risks.

Port Number

The default port is 80 and should **NOT** be changed except in the following situations.

1. If IP addresses are scarce in your network environment, consider using a network address translation (NAT) router. With such a device, several PPM100's can 'share' a single IP address. Each PPM100 is assigned a 'fictitious' IP address and the router presents a single IP address to the rest of the world. In this case, all of the PPM100's will appear at the same IP address to the outside world (they will have different IP addresses on the local network). Each PPM100 needs to be on a different port and the router must be configured to forward port requests to the correct PPM100. From the outside, each PPM100 is accessed at its own port number (but the same IP address).
2. If you are experiencing attacks on port 80 that block access to the PPM100. In this case, change the port to something else (like 8080). You will need to specify this port in your browser address window as 208.123.123.32:8080 where 208.123.123.32 is the IP address of the PPM100 and 8080 is the port number.

For more information about NAT routers and ports, see your network administrator.

Setting Network Addresses

To enter network addresses into the PPM100, press the [Menu] QuickKey from the Pressure Display, then choose [Remote] from the Main Menu. Finally, choose [Web] in the Remote Menu.

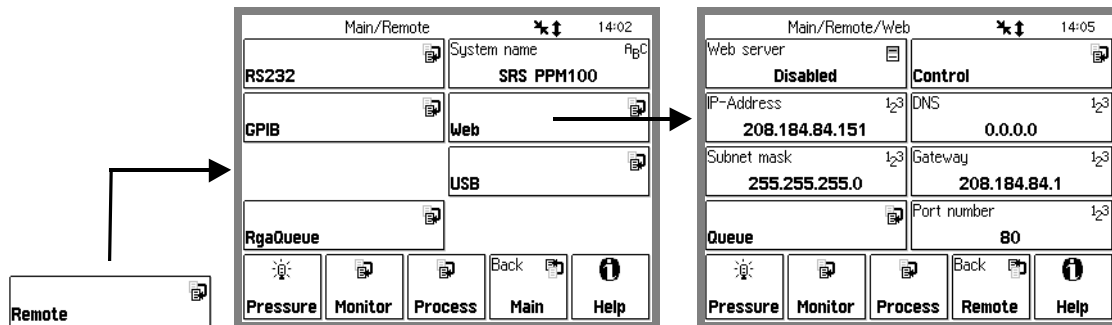

Figure 7-2. Getting to the Web menu.

In order to use the EWS, you will need to have a connection to the internet and some information about your network environment.

The best source of information about your network environment is your network administrator. Here is a list of information you will need from that person:

- 1) An IP (Internet Protocol) address for the instrument
- 2) The IP address of a domain name server (DNS)
- 3) The IP address of the gateway
- 4) The address of a simple mail transfer protocol (SMTP) server
- 5) The Subnet mask

An IP address is made up of four bytes. It is often expressed as a set of three digit numbers separated by a '.' such as 209.239.160.084. The Internet protocol maps each machine's individual media access control (MAC) address to an IP address. Every page you are served from the world wide web is actually from a machine with a particular IP address.

People have a difficult time remembering and using long strings of numbers, so domain name servers (DNS) are in use. You can think of these machines as a kind of telephone book; they associate a particular IP address (209.239.160.084) with a string of characters (www.thinksrs.com). A DNS is not required to use the EWS, but it can make your life a little easier.

Next we need to consider the gateway. The gateway is simply the machine that connects your network to the outside world. It is the link between two networks, routing data traffic between those networks. For this reason, a gateway is sometimes referred to as a router. Its IP address is required for you to be able to send email from the EWS. If you will not be using the email notices feature of the EWS, and you will always be contacting the EWS from a machine on the same network, this IP address is not required.

A simple mail transfer protocol (SMTP) server often has one purpose in life: to relay email from one machine to another. It follows some simple rules for how the information that makes up the email is exchanged between the machine sending the email and the machine that will relay the message to its destination. This address is not required if you will not be using the email feature of the EWS.

Lastly, the subnet mask is required. In a network, there are quite often sub-networks. The subnet mask is required to let the EWS know which subnet it will be on.

Enable the EWS

After entering network addresses, set the Web Server to Enabled. Your EWS stores the network addresses into non-volatile memory, then gathers data on your PPM100 setup (gauge and relay descriptions, etc.). Allow the EWS about 30 seconds before continuing.

To make sure the EWS is functioning, touch the [Web Queue] button. If commands are streaming across the display, the EWS is communicating with the PPM100.

Important

Whenever network setup information is changed, the new addresses are read and burned into flash memory, then the EWS is re-started. You must wait at least 5 seconds for the changes to take effect.

System Name

The System Name (Menu/Remote/System Name) identifies this PPM100 on the web. This is important if your setup includes multiple web-enabled PPM100's. The system name is displayed in the web pages to identify the source of the data.

MAC Address

Your administrator may want to know the media access control (MAC) address of your instrument. The MAC is a unique address used at a lower layer of the internet protocol. Each IP address is mapped to a unique MAC address. Administrators often like to know this address as a crosscheck for the IP address (both should be unique). Knowing the MAC address also provides some extra security; if the administrator finds a MAC address that isn't listed in their directory, it could be an unauthorized user. When you put a server on a network, you are essentially inviting people to come and get information. Your administrator will want to make sure that this server doesn't create a security risk for the rest of the network.

To find the MAC address of your PPM100 from a standalone PC use a crossover cable to connect the PPM100 to the PC. Type in the PPM100's IP address (and port if not 80) in your browser's address window. This should bring up the PPM100 web page. Click on "Get Userlog" on the left. This displays the network settings of the PPM100 including its MAC address.

Choosing a Network Configuration

This section illustrates some possible network configurations for the EWS. This may help in choosing the best network configuration for your EWS.

Crossover Cable Configuration

This setup uses a crossover ethernet cable that allows the EWS to connect to a single computer without a network. A crossover cable is wired differently than regular network cables. A normal ethernet cable is wired 'straight through' (Tx to Tx, Rx to Rx), while a crossover cable connects transmit to receive (Tx to Rx, Rx to Tx). *To use this configuration, make sure you use a crossover cable!*

This configuration will **NOT** allow email, use of a DNS, or access from more than one computer. It will **NOT** allow the computer connected to the PPM to connect to the internet. However, it does allow you to use a standard web browser to monitor, control and receive data from the PPM100.

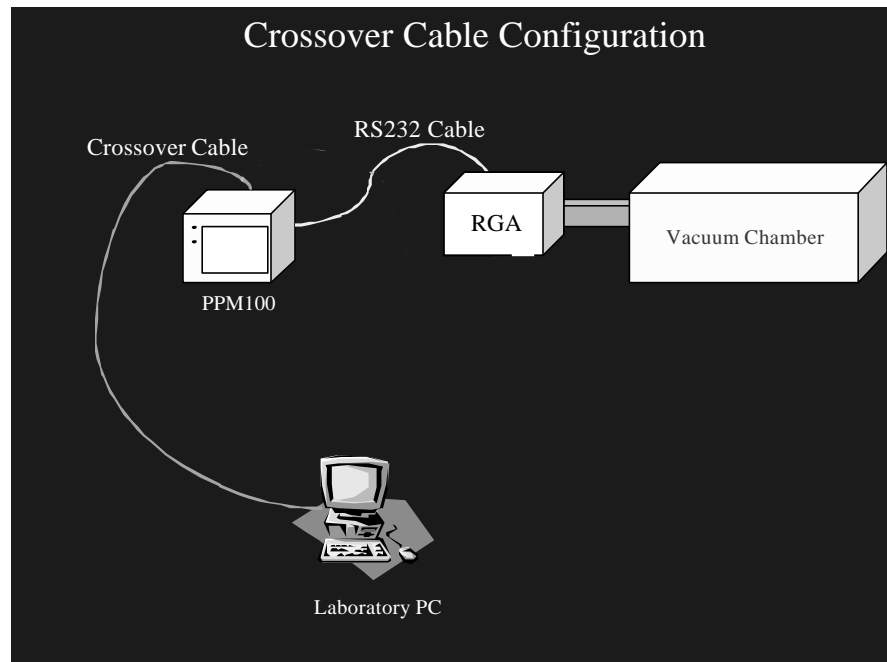

Figure 7-3. Crossover Cable Configuration

This configuration does **NOT** allow access to the PPM100 from the outside world. However, if security is a concern, this limitation is a strong reason for its use. The only security question to ask is "who will have access to this computer?". Since there is no intermediate connection, or dependence on outside hardware, this is also a very reliable connection. Furthermore, since the EWS will not actually be on the internet, you do not need a 'real' IP address. The crossover cable forms a 'network' of one PC to one instrument. Since you have created your own enclosed network, you can use any IP addresses you wish; use the same subnet mask for both the PC and the PPM100. See the section below entitled "Testing with a crossover cable" for more details.

Internal LAN Configuration

You can retain the security of the crossover connection and still allow more than one computer to access the PPM100. An ethernet hub will allow you to make a local area network (LAN) that can use fictitious IP addresses in order to access the instrument (as well as other computers on the LAN). The figure below shows a conceptual diagram of this configuration. While the IP addresses are fictitious, other networking parameters are still required and your network administrator can help you set up this type of LAN.

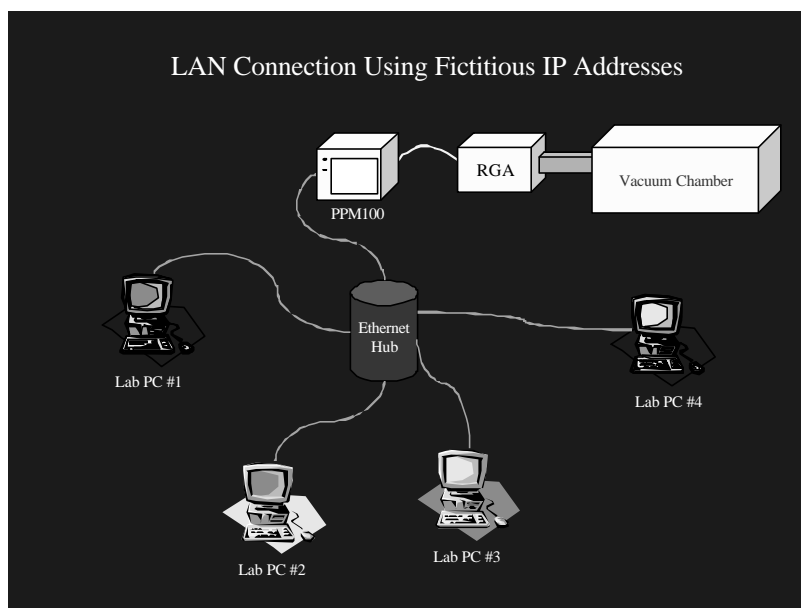

Figure 7-4. Internal LAN Configuration

Note that no connection to the internet is made in this LAN. The network is completely within your laboratory or plant floor, so security from an outside attack on this LAN is not a concern. Of course this also means that *you* cannot access the LAN outside of the workplace. However, the PPM100 *can* be accessed from other computers on the same LAN.

Conventional LAN Configuration

Chances are good that you are currently using a LAN with real IP addresses that is also connected to the internet through a firewall. A firewall is a piece of hardware designed to exclude unwanted data traffic coming from the outside world. A gateway is often employed in order to allow data traffic from the LAN to reach the outside world. Within a LAN that is using real IP addresses, you need to contact your network administrator in order to set up your EWS. For details, see the section 'Network Administration Concerns'.

This configuration allows anyone on your LAN to use the EWS. With a gateway in place, it also allows the EWS to send out email to a computer which is outside the LAN. However, this configuration may not allow you to monitor or control your vacuum system from outside your workplace. Talk with your network administrator for their advice on setting up this configuration to allow outside access to the PPM100. To maintain the security of the LAN, your administrator may wish to place the PPM100 outside the firewall, as described in the next section.

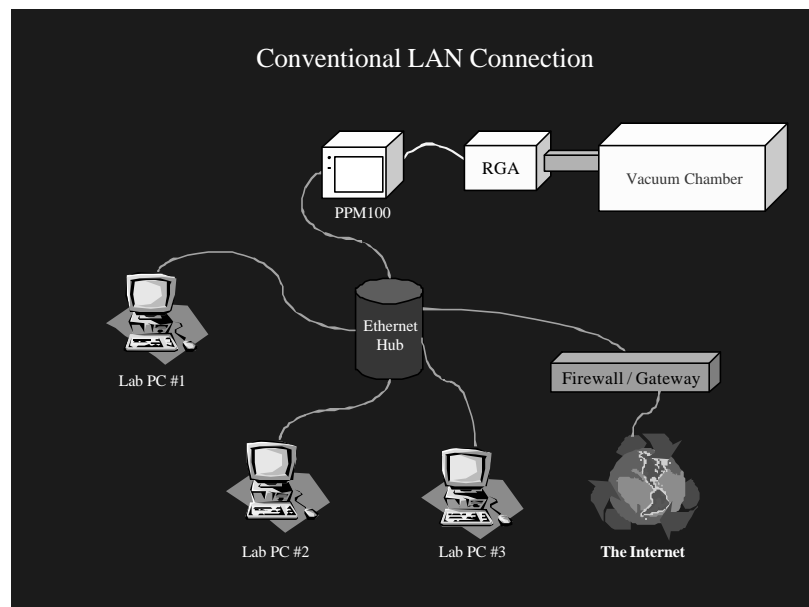

Figure 7-5. Conventional LAN Configuration

Outside Firewall Configuration

Here, the PPM100 is connected to the world wide web via a router outside the workplace firewall. This connection requires setting up real network parameters (as discussed in the previous sections) and your network administrator should work with you to set up this type of connection. This configuration allows you to interact with your instrument from any computer, anywhere on the internet, via a standard browser. You can monitor your data, control relay states, and even receive email notification about relay state changes, from any location. There is a trade-off for all this flexibility and power. Once your instrument is accessible throughout the world, security issues must be addressed. See 'Configuring EWS Security' later in this chapter.

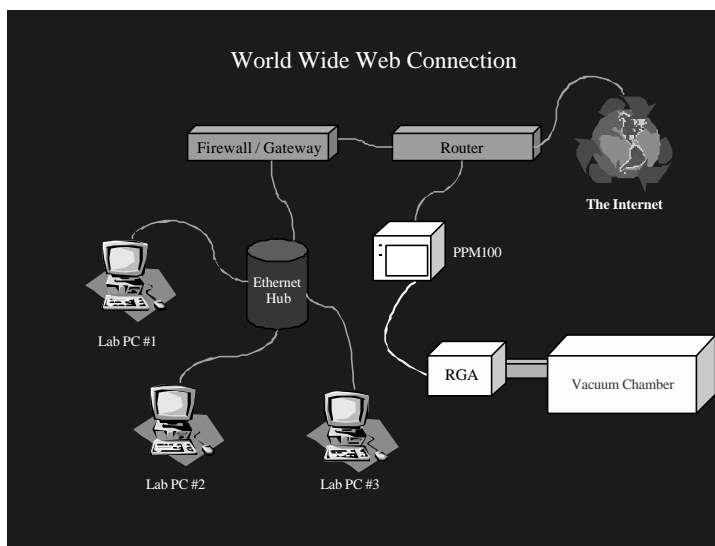

Figure 7-6. Outside Firewall Configuration

Testing with a Crossover Cable

Before putting your instrument on the web, it is best to test it via a direct PC to instrument connection. You will need an ethernet crossover cable, and a computer with a network card, already configured with network parameters. If you need to set up a computer for networking, contact your network administrator. Please do not contact SRS for support of your network. A workstation attached to the same network you wish to use the EWS with is ideal for this test. If the computer is already hooked up to a network, make sure disconnecting it will not cause problems for others on that network.

In this crossover configuration, real networking parameters (Subnet mask, DNS, Gateway) are not required.

- 1) Make sure the PPM100 is powered up and running normally.
- 2) Disconnect the computer from its ethernet network.
- 3) Connect the PPM100 EWS to the computer using a crossover cable.
- 4) From the command line prompt of your workstation, enter the command 'ipconfig'. This command will report the workstation's IP address.
- 5) On the PPM100, go to the Main/Remote/Web menu. Make sure the EWS is Disabled.
- 6) For this test, the IP address can be 'fictitious'. Set the EWS to use a fictitious address by subtracting one from the IP address of your workstation. For example, if your workstation IP address was reported as 111.111.111.111, use 111.111.111.110 for your fictitious EWS IP address. This is the only networking parameter required for this crossover test.
- 7) In the PPM100 Main/Remote/Web menu, set EWS to Enabled. This sets the IP addresses in the EWS and starts the EWS.
- 8) Under Main/Remote/Web, touch [Web Queue]. This screen should show web server activity as it queries the PPM for information. Allow the web server to gather information from the PPM for several seconds.
- 9) Run a web browser on your workstation. At the browser's "http://" prompt, type the fictitious IP address you set on the PPM100 front panel and hit the return key. In a moment, you should see the opening screen of the web page.

If you did not see the opening screen within a few seconds, make sure of the following:

- The web server is enabled. Check Main/Remote/Web/Web Queue (see above) for activity.
- When the cable is plugged in and the server is enabled, a green activity light on the ethernet connector on the rear panel should be illuminated. Verify this light is on. If it does not light, there may be a hardware problem with the crossover cable or your PC network card.
- The IP address on the front panel of the PPM100 matches the IP address you typed in on your browser.
- The crossover cable is connected directly from the PC to the PPM (no hub or switch is in the path).

- The cable is wired as a crossover cable.
- If the web page display seems garbled or if parts are incomplete, try waiting a few seconds and reloading the page in your browser. The most likely cause for this problem is that the web server has not had time to initialize.

Testing Within a Network

In order to test your EWS with a real network, you will need an IP address from your network administrator. You will also need the subnet mask, and IP address of the default gateway machine. You can get these addresses from the administrator. If you wish to use electronic mail, you may also wish to obtain the address of a domain name server (DNS).

- 1) Make sure the EWS is Disabled (Go to the Main/Remote/Web menu on the PPM100 if necessary).
- 2) Set the IP address.
- 3) Set the gateway address and subnet mask.
- 4) Connect the PPM100 EWS to a hub (or other network connection) with a standard ethernet network cable. *Do not use a crossover cable.*
- 5) In the PPM100 Main/Remote/Web menu, set EWS to Enabled. This sets the IP addresses in the EWS and starts the EWS.
- 6) Under Main/Remote/Web, touch [Web Queue]. This screen should show web server activity as it queries the PPM for information. Allow the web server to gather information from the PPM for several seconds.
- 7) Run a web browser on your computer. At the browser's "http://" prompt, type the IP address you entered on the PPM100 front panel and hit the return key.

If you did not see the opening screen within a few seconds, make sure of the following:

- The web server is enabled. Check Main/Remote/Web/Web Queue (see above) for activity.
- When the cable is plugged in and the server is enabled, a green activity light on the ethernet connector on the rear panel should be illuminated. Verify this light is on. If it does not light, there may be a hardware problem with the crossover cable or your PC network card.
- The IP address on the front panel of the PPM100 matches the IP address you typed in on your browser.
- The ethernet cable is connected from the PPM100 to a hub or other ethernet port (not directly to a PC).
- The cable is *NOT* a crossover cable.
- If the web page display seems garbled or if parts are incomplete, try waiting a few seconds and reloading the page in your browser. The most likely cause for this problem is that the web server has not had time to initialize.

Note

Your local network environment may prohibit your ability to get web pages from the EWS from outside your facility. See the section below entitled 'Network Configurations' and consult your network administrator for possible solutions.

Configuring EWS Security

You must decide if the PPM100/EWS offers enough security for your application. The EWS employs a number of security measures, however, *no network can be made entirely secure!* All security measures are implemented from the front panel of the PPM100 and cannot be changed via the web interface. This ensures that only authorized users set security levels.

Monitoring of the PPM100 through the EWS is allowed for all users. The security measures are designed to prevent unauthorized users from making changes to the PPM100 settings.

Web Server Enable

If you use your EWS only during certain hours, simply disable it when not in use. No web monitoring or control of the PPM100 is possible when the EWS is disabled. This setting can only be changed from the front panel.

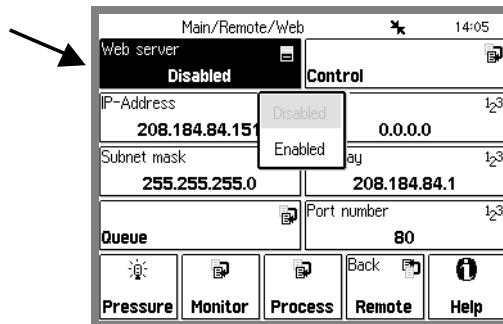

Figure 7-7. Web server enable/disable.

Important

Whenever network setup information is changed, you must wait at least 5 seconds for the changes to take effect.

Web Control Enable

If you only wish to monitor your vacuum system from the web, you should disable Web Control. Web Control of the PPM100 includes setting relay states, running scans, and configuring email. When control is disabled, the EWS does not allow changes to the PPM100 settings. If you allow web control, make sure that the security features below are enabled.

Touch [Control] in the Main/Remote/Web menu to access the control and security features of the EWS.

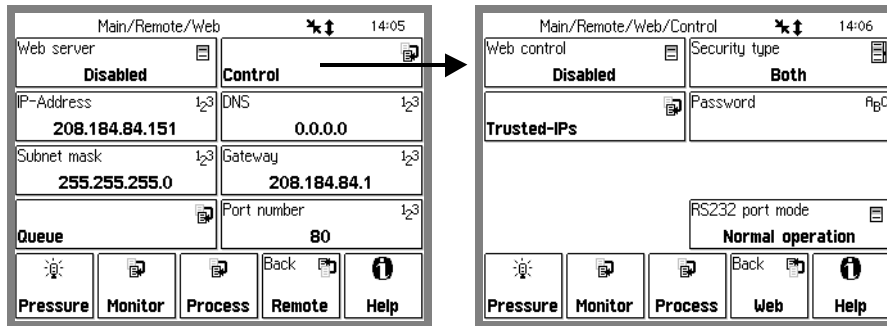

Figure 7-8. Web Control menu.

Security Type

The PPM100 offers a choice of security options when web control is enabled.

IP Checking

Within a networking environment in which the IP addresses do not change (the IP addresses are static), you can limit who has access to the instrument by checking the IP address of users asking for data.

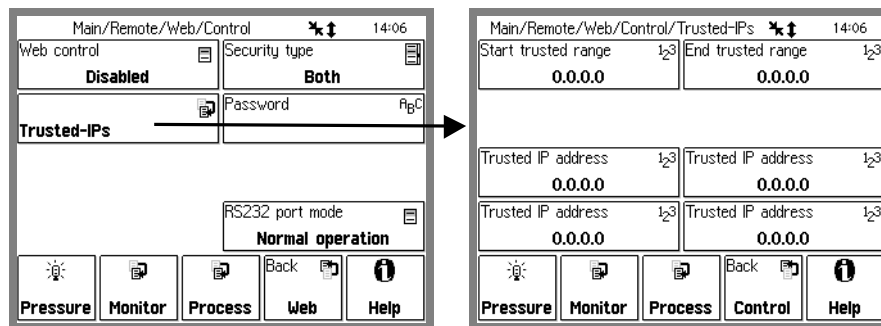

Figure 7-9. Trusted-IP setup menu.

The PPM100 allows you to specify the IP addresses that will be allowed to access the instrument over the web. You may specify a range of addresses as well as four addresses that are outside that range. The addresses outside the range are for trusted users outside the local network with static IP addresses. If your network uses dynamic IP addresses, but they always fall in the same range, you can still use IP checking security. If you do not require control of the EWS via a dial-up connection, this is the security measure to use.

Note that no password is required - if the IP address is trusted, control access is granted.

IP and Password Checking

As an extra measure of security in addition to IP checking, you can also assign a password to gain access to control of the PPM100. If you have set special parameters that are to remain unchanged even by in-house personnel, this is this measure to use.

Password Checking Only

This is the lowest level of security for the PPM100's control functions. However, if you require access to the control functions over a dial-up connection to the instrument, this is the method to use. A dial-up connection almost always assigns a different IP address to your connection each time you log on to your internet service provider (ISP). This means IP checking is not a feasible option.

Note

The password exchange is not encrypted. This means that if someone is monitoring your communication with the EWS, they will see your password.

Using the EWS

To view the EWS web pages, simply type the IP address of the EWS into your web browser.



Figure 7-10. Enter the PPM100's IP address into your browser.

The screenshot shows the main EWS web page in Microsoft Internet Explorer. The page features the SRS logo and the text "Web-Enabled PPM100 Name: SRS PPM100". The "Function : MONITOR" is selected, and the "Last Reading : 15jul03 at 13:31" is displayed.

Gauges

Gauge	Reading	Name
PP1	1.68-07 Torr	Hydrogen
PP2	5.31-09 Torr	Helium
PP3	2.71-07 Torr	Water
PP4	2.44-06 Torr	Nitrogen
PP5	4.87-07 Torr	Oxygen
PP6	4.05-08 Torr	Argon
PP7	8.10-09 Torr	Pump oil
PP8	1.21-07 Torr	CO2
AN1	+6.822 V	FLOW CONTROLLER
AN2	+5.319 V	PULSED VALVE
AN3	-0.212 V	HEATING JACKET
AN4	+7.984 V	THROTTLING VALVE

Relay Status

Channel	1	2	3	4
Description	GATE VALVE	HEAT JACKET	TURBO PWR	WATER LINES
Current State	INACTIVE	INACTIVE	INACTIVE	INACTIVE
	MANUAL	MANUAL	MANUAL	MANUAL

Channel	5	6	7	8
Description	DETECTOR	DIFF PUMP PWR	PULSED VALVE	MECH PUMPS
Current State	INACTIVE	INACTIVE	INACTIVE	INACTIVE
	MANUAL	MANUAL	MANUAL	MANUAL

Running on a Xessm Web Controller

Figure 7-11. Main EWS web page.

Bookmarking the PPM100

You can add a bookmark to the PPM100 in your browser. Be sure to rename the bookmark to something meaningful. If you are accessing multiple PPM100's, make sure each bookmark is unique.

Monitoring the PPM100

The simplest use of the EWS is to monitor your data. The EWS offers four distinct ways to monitor.

- Display a page with all active gauges and current relay states
- Monitor selected parameters in an automatically updated window
- Display the data log to see how your system is behaving over time.
- Display a graph of partial pressure versus time or partial pressure versus mass (MassSpec Display).

Get Readings

Get Readings reports the value of all inputs that are not in an error state as well as the process control relay states. If a gauge reading does not appear, use the Auto Monitor function described below to display the error state of the gauge. Note that all analog ports which can be converted to capacitance manometer readings are listed twice; the display shows both the analog voltage and the corresponding pressure value.

The system name (default "SRS PPM100") can be changed in the Main/Remote menu of the PPM100. This is important if you are monitoring multiple units.

This screen only updates when you click Get Readings. For continuous updates, use Auto Monitor.

Show Stored Plot

Show Stored Plot exists to allow examination of a pressure graph after it is acquired. If the system the PPM is sampling shows unusual yet transient behavior, performing the scan again at a later time may not reveal the problem. Any plot (analog scan, pressure versus time chart or voltage versus time chart) is automatically stored in the EWS memory after it is acquired. If desired, a technician can inform a supervisor at a remote location to look at the unusual scan through Show Stored Plot. Note that only one plot can be stored at any given time. If a new plot is acquired, it overwrites the old one. Access of the stored plot is allowed by all users, even those without control privileges.

Auto Monitor

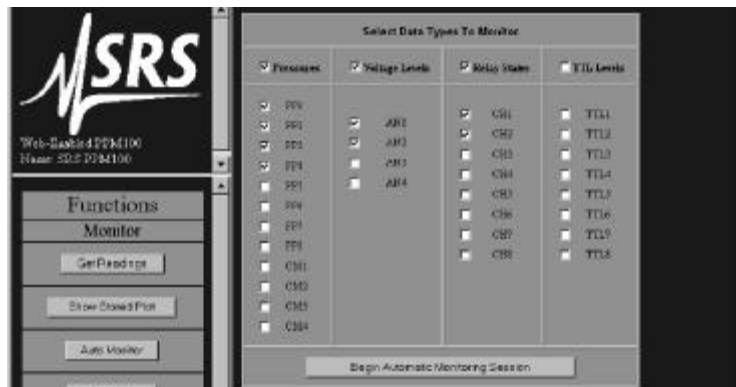

Figure 7-12. Auto Monitor menu.

This function allows automatic monitoring of specific inputs or values. Select the quantities you wish to monitor from the menu and how often you wish the display to update. A new browser window will be created displaying only the selected data. This window will refresh every 20 seconds (depending upon network availability). The auto monitor function will show the status of a gauge that cannot report a value.

The auto monitoring window can be on your desktop while you work, allowing you to keep tabs on critical parameters (see below). You can create multiple windows to group critical parameters by type, or use a single window and look at several types of data at once. This feature can be especially useful when a relay state is tied to a pressure reading; you can make absolutely sure that the relays are functioning correctly with the given pressure input. These same ideas can be applied to the analog inputs to monitor parameters such as temperature.

Gauge Type	Gauge Reading	Gauge Name
PP1	9.30-09 Torr	Hydrogen
PP2	3.96-10 Torr	Helium
PP3	1.32-08 Torr	Water
PP4	1.67-07 Torr	Nitrogen
AN1	-0.247 V	FLOW CONTROLLER
AN2	+6.163 V	ARGON OUT
CH1	ON	GATE VALVE
CH2	OFF	HEATING JACKET

Figure 7-13. Auto Monitor window.

Process History

This function will return up to the last 20 events in the process history. Each entry of the history has a timestamp, a listing of what relays were active at that moment, a listing of what relays were under automatic control at that moment, and what change took place at that moment. By examining the process history, you can trace how your vacuum system arrived in its current state. Often, you can quickly diagnose a problem in your vacuum system when you learn which interlocks were activated and the order in which they were activated.



Process Control History						
Timestamp	Active Relays	Automatic Relays	Channel	Name	Change	
12feb03 15:34:32	10101110	10101000	3	DIFF PUMP PWR	State Inactive	
12feb03 15:32:44	10101111	10101000	2	HEATING JACKET	Mode Manual	
12feb03 15:32:12	10101111	11101000	1	GATE VALVE	Mode Auto	
12feb03 15:32:09	10101111	01101000	1	GATE VALVE	State Active	
12feb00 15:30:47	00101111	01101000	6	FLOW CONTROL	State Active	
12feb00 15:30:47	00101011	01101000	6	FLOW CONTROL	Mode Manual	
12feb00 15:30:31	00101011	01101100	1	GATE VALVE	State Inactive	
12feb00 15:30:31	10101011	01101100	1	GATE VALVE	Mode Manual	
12feb00 15:30:21	10101011	11101100	3	ARGON VALVE	State Active	
12feb00 15:30:11	10100011	11101100	4	WATER LINES	State Inactive	
12feb00 15:26:17	10110011	11101100	3	TURBO PWR	State Active	
12feb00 15:25:59	10010011	11101100	1	GATE VALVE	State Active	
12feb00 15:24:54	00010011	11101100	3	DIFF PUMP PWR	State Active	
12feb00 15:24:47	00010010	11101100	7	MECH PUMPS	State Active	
12feb00 15:24:43	00010000	11101100	6	FLOW CONTROL	Mode Auto	
12feb00 15:24:41	00010000	11101000	5	ARGON VALVE	Mode Auto	
12feb00 15:24:33	00010000	11100000	4	WATER LINES	State Active	
12feb00 15:24:09	00000000	11100000	3	TURBO PWR	Mode Auto	
12feb00 15:24:07	00000000	11000000	2	HEATING JACKET	Mode Auto	
12feb00 15:23:39	00000000	10000000	1	GATE VALVE	Mode Auto	
12feb00 14:45:01	Instrument turned on					

Figure 7-14. Process History.

Get Datalog

The Get Datalog function downloads PPM100 log data to your computer, via the web. You can select data from four categories: pressures, analog port values, relay states, and TTL levels. The data is downloaded either as a web page or as a comma separated variable (.csv) file compatible with Microsoft Excel.

Web Output

The number of log points in a web page is fixed at 10 points per data type.

Datalog Generated at 12feb03 at 15:44

Partial Pressures								
TIMESTAMP	PP1	PP2	PP3	PP4	PP5	PP6	PP7	PP8
12feb03,15:44:05	9.50-09	3.32-10	1.39-08	1.70-07	3.22-08	2.98-09	1.07-09	4.78-09
12feb03,15:44:03	9.50-09	4.18-10	1.39-08	1.70-07	3.22-08	2.98-09	1.07-09	4.78-09
12feb03,15:44:01	9.21-09	4.18-10	1.39-08	1.70-07	3.22-08	2.98-09	1.07-09	4.78-09
12feb03,15:43:59	9.21-09	4.18-10	1.39-08	1.70-07	3.22-08	2.98-09	1.07-09	4.63-09
12feb03,15:43:57	9.21-09	4.18-10	1.39-08	1.70-07	3.22-08	2.98-09	9.02-10	4.63-09
12feb03,15:43:55	9.21-09	4.18-10	1.39-08	1.70-07	3.22-08	2.98-09	9.02-10	4.63-09
12feb03,15:43:53	9.21-09	4.18-10	1.39-08	1.70-07	3.20-08	2.98-09	9.02-10	4.63-09
12feb03,15:43:51	9.21-09	4.18-10	1.34-08	1.68-07	3.20-08	2.98-09	9.02-10	4.63-09
12feb03,15:43:49	9.21-09	3.09-10	1.34-08	1.68-07	3.20-08	2.98-09	9.02-10	4.63-09
12feb03,15:43:47	9.43-09	3.09-10	1.34-08	1.68-07	3.20-08	2.98-09	9.02-10	4.63-09

Capacitance Manometer Pressures				
TIMESTAMP	CM1	CM2	CM3	CM4
12feb03,15:44:05	N/A	N/A	N/A	N/A
12feb03,15:44:03	N/A	N/A	N/A	N/A
12feb03,15:44:01	N/A	N/A	N/A	N/A
12feb03,15:43:59	N/A	N/A	N/A	N/A
12feb03,15:43:57	N/A	N/A	N/A	N/A
12feb03,15:43:55	N/A	N/A	N/A	N/A
12feb03,15:43:53	N/A	N/A	N/A	N/A
12feb03,15:43:51	N/A	N/A	N/A	N/A
12feb03,15:43:49	N/A	N/A	N/A	N/A
12feb03,15:43:47	N/A	N/A	N/A	N/A

Figure 7-15. Web Output of datalog.

CSV Output

The CSV file is downloaded when you click Get Datalog. If the browser is not set up to automatically handle a .csv file, the data will be displayed in the browser. Users of Netscape Navigator can easily configure the browser to automatically launch Excel (or another graphing program) whenever a .csv file is downloaded.

In Navigator:

- 1) Go to Edit in the menu bar, and choose Preferences.
- 2) In the Category pane, double click on Navigator, then click on Applications.
- 3) Click on New Type. Enter the description "comma separated values", file extension "csv", MIME type "text" and browse to your application. Do not type the quote symbols!
- 4) Click OK.
- 5) Download the CSV data and your chosen application should open.
Remember, the application must be able to handle data in this format!

Internet Explorer uses the Windows file associations. Installing Excel usually associates .csv files to Excel. If you need to add the association, go to Windows Explorer or My Computer. Go to View in the menu bar, then choose Options. Click on the File Types tab. Either edit an existing entry or add a new one.

If Internet Explorer will not automatically open Excel, try saving the downloaded .csv data to a file. To do this, right-click on the downloaded data frame and choose view source. This usually opens a Notepad window with the data in it. Save this file to disk. Either double-click on this file to launch Excel or open it from within Excel.

Some browsers may require a page reload after a CSV download. Simply hit the 'reload' icon in your browser.

Note

The EWS is limited in how much data it can send out at a time. Selecting fewer quantities (for example, pressures only instead of pressures and relay states) will increase the number of log points you acquire in a single CSV download.

Get Userlog

This feature is simply for security purposes. It displays the recent activity on the EWS and it shows the IP address and files accessed.

The network settings of the PPM100 are also displayed, including the MAC address.

Email Status

This page displays information about email notification including a summary of the email setup and a list of emails which have been sent from the PPM100. In addition, the number of messages sent is shown along with the maximum number allowed.

For more information about setting up email, see the next section 'Controlling the PPM100'.

Controlling the PPM100

The world wide web allows the ultimate in remote control. You can change parameters of the instrument from virtually any location. For security purposes, the EWS only allows control of relay states, email configuration, some RGA settings and obtaining pressure graphs. All the control functions are under the security layer and require either the correct trusted IP address and/or password in order to gain access.

Request Control

If web control is disabled from the front panel of the PPM100, the control functions do not appear on the EWS web pages. If control is disabled while someone is browsing the page, the control functions will still be in the web page, but any control operation is prevented.

You must log on as the controller before any of the control functions can be accessed. Click this button to log on as the controller. Once you log in, the page reloads, and this button is re-drawn as 'Release Control'. Only one user can have control of the EWS at a time.

The log on prompt depends upon the type of security selected on the PPM100. If you have selected password or both password and IP checking security, you will have to enter the password. If you are just using IP checking for security, no password is required. In both cases, you will need to enter a controller name for identification purposes.

If someone is already controlling the instrument, you will be informed of their log on name, their IP address, and how long it has been since that controller performed a control function (their idle time). If the current controller has been idle for hours, it is likely they simply forgot to logout by clicking 'Release Control'. For this reason, *you are allowed to take control from an idle user, provided you know the password and/or have a trusted IP.*

Release Control

Click this button to logoff as the controller of the instrument.

Note

Email notification will remain enabled after control is released.

Get Chart Type

This function provides a way to get pressure or voltage versus time graphs over the world wide web. You first select the chart type from a drop-down list. You can select to plot a partial pressure (PP1-8), a capacitance manometer pressure (CM1-4) or a voltage (AN1-4) versus time. Clicking on the button "Get Chart Type" produces the chart. The time span of the chart depends upon the chart X-axis setting keyed in on the front panel of the PPM100. A typical result from a partial pressure plot is shown in Figure 7-16. If you need to change the displayed pressure range, click on "Analog Scanning" and change the pressure range on that page (see "Analog Scanning" below). Note that the charts plot new data on the left and old data on the right; this is opposite from the way the data are plotted on the PPM100 chart display.

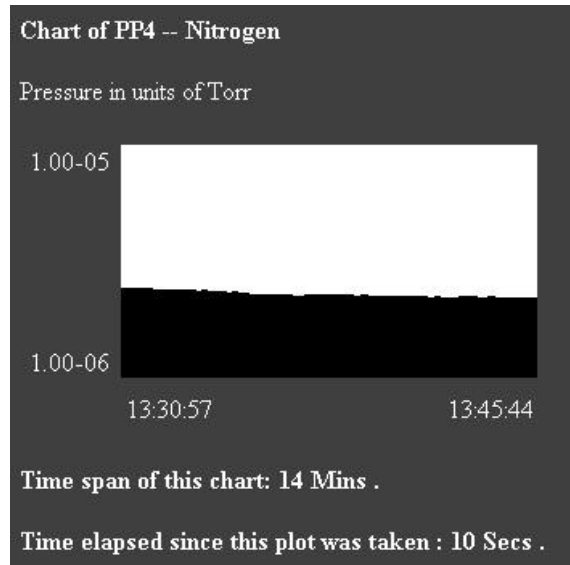

Figure 7-16. Partial pressure versus time chart.

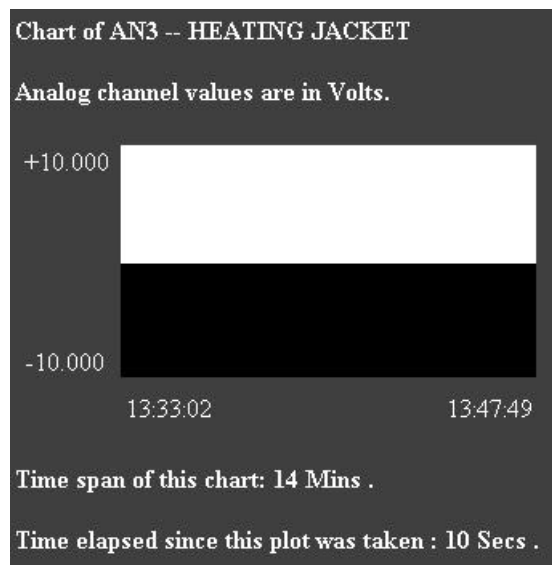

Figure 7-17. Voltage versus time chart.

MassSpec Display and Analog Scanning

Warning!

Process control is disabled during an analog scan. The interruption of process control may be lengthy depending upon the scan's parameters. If your PPM100 is actively being used for process control, be sure that it is safe to interrupt your process before performing an analog scan.

This function allows you to set up and acquire an analog scan similar to that shown in Figure 7-18.

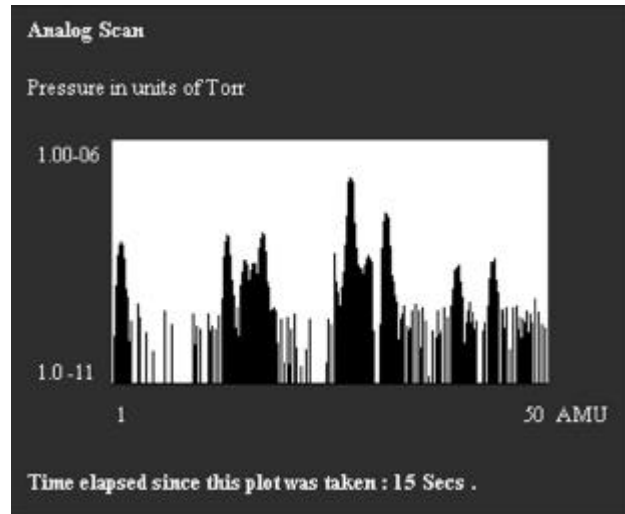

Figure 7-18. An Analog Scan.

You can control the RGA's filament and electron multiplier from the analog scan page (Figure 7-19) as well as setting scan range, noise floor, and displayed pressure limits.

WARNING!		
Process control is suspended during analog scans!		
Filament Control		
<input type="button" value="Click to Turn Emission Off"/>		
Scanning Parameters		
Mass Range (AMU)	Pressure Range (Torr)	Dynamic Range
Initial <input type="text" value="1"/>	Maximum $1 \text{ E} - 6$ <input type="button" value="v"/>	Noise Floor <input type="button" value="2"/> <input type="button" value="v"/>
Final <input type="text" value="50"/>	Minimum $1 \text{ E} - 10$ <input type="button" value="v"/>	Multiplier <input type="button" value="Off"/> <input type="button" value="v"/>
<input type="button" value="Click to Set Parameters"/>		
WARNING!		
Process control is suspended during analog scans!		
<input type="button" value="Click to Accept all Parameters and Begin Analog Scan"/>		

Figure 7-19. Analog Scan Setup.

Filament Control

Filament control is a "dynamic button". The function of the button changes depending upon the current state of the RGA. For example, if the RGA's filament is off when this

page is loaded into your browser, the button's label will read "Click to Turn Filament On" and clicking the button will send a request to energize the filament. If the RGA's filament is already on when the page is loaded, the label will read "Click to Turn Filament Off" and clicking the button will send a request to turn the filament off.

Multiplier Control

Multiplier control is a "dynamic button". The function of the button changes depending upon the current state of the RGA. For example, if the RGA's electron multiplier is off when this page is loaded into your browser, the button's label will read "Click to Turn Multiplier On" and clicking the button will send a request to activate the electron multiplier. If the RGA's multiplier is already on when the page is loaded, the label will read "Click to Turn Multiplier Off" and clicking the button will send a request to turn the filament off. Note that your RGA must be equipped with an electron multiplier (RGA Option 01) for this button to have physical meaning.

Scanning Parameters

If you are satisfied with the state of the filament and multiplier, you may still need to adjust some parameters before your scan begins. Each parameter and its function is described below. When you are satisfied with the parameters, press the button labeled "Click to Set Parameters". The changes you made will be sent to the PPM and RGA, and the page will be re-drawn to reflect these changes. If you are happy with the changes, "Click to Accept all Parameters and Begin Analog Scan".

Note

Your scanning parameter changes are NOT submitted until you press the button labeled "Click to Set Parameters". Do not press "Click to Accept all Parameters and Begin Analog Scan" before your changes are submitted.

Mass Range

Set the initial and final mass for your scan by typing values (in AMU) into these boxes. Make sure that your final mass is within the mass range allowed by your RGA (≤ 100 for an RGA100, and so on).

Pressure Range

This parameter allows you to set the minimum and maximum displayed pressure. Rather than keying in a number as in the Mass Range parameters, a drop-down box is used to allow quick changes of scale. Click on the drop-down box and choose an exponent from 0 to -12. For each parameter, this gives a range of 1 to $1\text{E-}12$ in the pressure units in force on the PPM.

Noise Floor

This parameter changes how fast the RGA performs a scan. A drop-down box is used to select a value from 0-7. If the noise floor is set to 7, the RGA scans very quickly. If the noise floor is set to 0, the RGA scans very slowly. The slower the scan, the better the signal to noise ratio (and the lower the detection limit).

Email Notices

This function allows configuration of the email notification feature. In order to use email, you must have entered a valid gateway address in the PPM100. A valid Simple Mail Transfer Protocol server (SMTP) address is also required. The gateway address is required so the EWS can access the SMTP server. The SMTP server is the machine (typically outside your network) that accepts email and routes it to the appropriate address. These addresses should be obtained from your local network administrator. A mnemonic address may be used only if the PPM100 has a valid DNS address entered.

Remember, email is inherently unreliable - SMTP servers fail, delivery time is inconsistent, you don't read your mail regularly, etc. *Use email notification as a backup to an interlock system, not in replacement of one.*

E-Mail Configuration		
SMTP Server: (IP or mnemonic)	<input type="text" value="129.156.023.040"/>	
From: (Set if needed)	<input type="text" value="ppm100@vacuumlab.com"/>	
Send Email To: (Primary addr.)	<input type="text" value="vacuser@vacuumlab.com"/>	
Cc Email To: (Secondary addr.)	<input type="text" value="othervacuser@vacuumlab.com"/>	
Send at most :	<input type="text" value="16"/>	E-mail notices
E-mail is :	<input checked="" type="radio"/> Disabled	<input type="radio"/> Enabled
Send A Test Message :		<input type="text" value="Type a test message here."/>
CH#/Desc.	Event:	Message Text (up to 50 chars)
<input checked="" type="checkbox"/> CH1 GATE VALVE	Activation	<input type="text" value="Gate Valve Open."/>
	Deactivation	<input type="text" value="Gate Valve Closed. Notify Bob @X221"/>
<input checked="" type="checkbox"/> CH2 HEATING JACKET	Activation	<input type="text" value="Heating Jacket On."/>
	Deactivation	<input type="text" value="Heating Jacket Off. End of Bakeout"/>
<input checked="" type="checkbox"/> CH3 TURBO PWR	Activation	<input type="text" value="Turbo pump on."/>
	Deactivation	<input type="text" value="Turbo Pump Off. Call Facilities x222."/>
<input checked="" type="checkbox"/> CH4 WATER LINES	Activation	<input type="text" value="Water Cooling On."/>
	Deactivation	<input type="text" value="Water Cooling Off! Call John x223"/>

Figure 7-20. Email configuration web page.

Testing the Email Function

It is very important to test the email function before using it routinely. If any address is incorrect, you will never get an email notice.

1. Set the SMTP address. Make sure you type it correctly. If you are using a verbose address (relay.mailhandling.com), make sure the DNS address was entered correctly on the PPM100.
2. Set the "from" address. The SMTP may require a "from" address that has a certain domain name. The domain name is typically the string after the '@' sign in an email address. For example, if your email address is me@mycompany.com, you may wish to use PPM100@mycompany.com as the "from" address. Ask your network administrator if a particular domain name is required to use your SMTP server.
3. Set the "to" address; this is the email address where you want notifications to be sent.
4. Click the 'Send A Test Message' button.

To learn the fate of your email message, click 'Email Status'. Your sent email and the reply from the SMTP server will be listed there. Any reply other than "250 - OK" is an error. Click 'Email Status' again to refresh the status if it was listed as "-2 -Awaiting reply". If the SMTP reply is "-1 : No Reply", a connection to the SMTP server was never made. Re-check your physical network connection as well as the gateway and SMTP addresses. If no error occurs, but you still do not receive the email, check the "from" and "to" addresses used.

Using the Email Function

Once you have successfully tested the email function, you can set a carbon copy (CC) address to send a copy of the notice to another user. Use only one email address in the CC field.

1. Set the email notices to "Enabled". A test message can always be sent by clicking the "Send A Test Message" button, even if email notification is disabled. If you will be unable to receive email for an extended period, it is a good idea to disable relay-linked email notification.
2. Set the maximum number of relay-linked email notices the EWS is allowed to send. This feature prevents accidental flooding of your mailbox. The default is 16. You probably wish to limit this number even further. The maximum cannot be set higher than 32. To reset the email count after a number of emails have been sent, disable email by setting the notices to "Disabled" and then clicking "Use This Email Configuration", then re-enable email.
3. Link process relays to email notices by clicking their checkboxes. The subject line of each email will be the channel number of the relay that changed and its new state, e.g. "Channel 1 : Inactive".
4. Enter a message you wish to send in the notification for both the activation and deactivation of the relay. Note the message cannot be more than 50 characters long.
5. Click "Use This Email Configuration" to store your email setup in the EWS. Verify the configuration is correct by clicking "Email Status".

6. Test that your configuration by manually changing the state of a linked relay from the front panel.

If you wish to clear the configuration when you begin a new process, click "Erase This Email Configuration".

To reset the email count after a number of emails have been sent, disable then re-enable email.

Note

Email notification remains enabled after control is released.

Change Relays

Warning!

Changing relay states from a remote interface can be dangerous. Make sure you understand your vacuum system and all process controls you have in place before using this feature.

By clicking this button, you receive a web page showing the current state of all eight relays of process control. You can set a relay to be active, inactive, or under automatic control. To send your desired relay states to the PPM100, click the button labeled "Click Here To Set All 8 Relays".

Function : CONTROL

Process Control Status at 12feb03 at 16:11

Channel	1	2	3	4
Description	GATE VALVE	HEATING JACKET	TURBO PWR	WATER LINES
Current State	ACTIVE	INACTIVE	ACTIVE	INACTIVE
	AUTO	MANUAL	AUTO	MANUAL
Desired State	<input type="radio"/> Inactive	<input checked="" type="radio"/> Inactive	<input type="radio"/> Inactive	<input checked="" type="radio"/> Inactive
	<input type="radio"/> Active	<input type="radio"/> Active	<input type="radio"/> Active	<input type="radio"/> Active
	<input checked="" type="radio"/> Auto	<input type="radio"/> Auto	<input checked="" type="radio"/> Auto	<input type="radio"/> Auto

[Click Here To Set All 8 Relays](#)

Channel	5	6	7	8
Description	ARGON VALVE	FLOW CONTROL	MECH PUMPS	DIFF PUMP PWR
Current State	ACTIVE	ACTIVE	ACTIVE	INACTIVE
	AUTO	MANUAL	MANUAL	MANUAL
Desired State	<input type="radio"/> Inactive	<input type="radio"/> Inactive	<input type="radio"/> Inactive	<input checked="" type="radio"/> Inactive
	<input type="radio"/> Active	<input checked="" type="radio"/> Active	<input checked="" type="radio"/> Active	<input type="radio"/> Active
	<input checked="" type="radio"/> Auto	<input type="radio"/> Auto	<input type="radio"/> Auto	<input type="radio"/> Auto

Figure 7-21. Relay control web page.

Networking Terms

Some terms that are used throughout this chapter are defined here.

Server

A server is simply a computer capable of delivering data to another computer. Typically, the server is *only* used to deliver data and all its resources are allocated to that task.

IP Address

Each computer that is connected to the world wide web needs to have a unique address in order for other machines to access that computer. An IP address is made up of four bytes. It is often expressed as a set of three digit numbers separated by a '.', e.g. 209.239.160.084.

Static IP Address

A static IP address never changes. Static IP addresses are often used for servers, so that computers on the web can find them.

Dynamic IP Address

A dynamic IP address changes frequently. Often, clients have dynamic IP addresses that are assigned to them when they boot up. When you use a dial-up connection, an IP address is assigned to you each time. This means you get a different IP address every time you log on from a dial-up connection.

Fictitious IP Address

Networks that are not directly connected to the world wide web sometimes use fictitious IP addresses valid only for local communication. Machines connected to this type of network are not directly accessible from outside that network. This improves security of the network and conserves the number of real IP addresses required for a facility. A network of fictitious addresses can be connected to the web using a router.

MAC Address

The media access control (MAC) address is another unique address that belongs to the physical network interface card. It is sometimes called an 'ethernet address'. It is often expressed as a series of hexadecimal codes separated by a dash (for example, 00-00-1A-18-FF-00). The Internet Protocol (IP) maps each machine's individual MAC address to an IP address.

DNS Address

People have a difficult time remembering and using long strings of numbers, so domain name servers are in use. You can think of these machines as a kind of telephone book - they associate a particular IP address (209.239.160.084) with a string of characters (www.thinksrs.com). A DNS is not required to use the EWS, but it can make your life a little easier.

SMTP Address

In order to send email, a special machine called a Simple Mail Transfer Protocol server is often used. These servers respond to commands for sending email and will forward your messages to the recipient's local mail handling machine.

Chapter 8

Troubleshooting and Maintenance

Troubleshooting a vacuum system can be a complex and daunting task. This chapter contains troubleshooting information for the PPM100. Please read and follow all warnings presented in this chapter. See 'Safety and Preparation for Use' at the beginning of this manual to remind yourself of some of the dangers involved in working with vacuum systems.

In This Chapter

Warnings	8-3
Resetting the PPM100	8-3
Error Detection	8-4
Built-in Checks	8-4
Event Logging	8-5
Remote Status Checking	8-5
Interface Queues	8-6
PPM100 Error Messages	8-7
Pressure/Voltage Display	8-7
RGA	8-8
Basic Troubleshooting	8-9
Input Power	8-9
RGA	8-9
Capacitance Manometer	8-11
Process Control	8-12
Analog I/O	8-12
Maintenance	8-13
Touchscreen	8-13
Damage Requiring Service	8-14

Warnings

- **Read and follow all 'Safety and Preparation for Use' warnings before handling this product (see front of this manual).**
- Dangerous voltages, capable of causing injury or death, are present in this instrument. Use extreme caution whenever troubleshooting any of its parts.
- Do not substitute parts or modify the instrument. Do not use the product if it has unauthorized modifications. Return the product to Stanford Research Systems for service and repair to ensure that safety features are maintained.
- Use only SRS supplied replacement/accessory parts.
- The PPM100 controller does not have any serviceable parts.
- Consult the 'Damage Requiring Service' section at the end of this chapter for instructions on how to return the instrument for authorized service and adjustment.

Resetting the PPM100

If the unit appears to be 'hung' and unresponsive to front panel inputs, disconnect and then reconnect line power.

To reset the instrument to its default settings, turn the unit on (using the red POWER key) while holding down the E. MULTIPLIER key.

Error Detection

Important

Diagnose and troubleshoot problems as soon as they are detected.

Even though the hardware tests built into the PPM100 can test the instrument for a large variety of problems, they cannot detect all possible error conditions.

If system downtime is of prime concern, it is recommended that a spare PPM100 unit be available for immediate replacement in the cause of failure or problems.

Built-in Checks

Several built-in hardware tests automatically check the RGA head when the unit is turned on. Additional tests are performed (as required) during the routine operation of the mass spectrometer. Error and Status registers, routinely queried by the PPM100, store the results of all tests in the RGA head's internal memory.

Tip

For a detailed listing of RGA Error conditions and Troubleshooting options, consult the RGA's Operation and Programming Manual.

Several additional built-in hardware test procedures automatically check the PPM100 electronics when the unit is turned on, and continuously track the internal workings of the controller during operation.

All detected PPM100 and RGA errors are immediately reported through on-screen messages, audio alarms, LEDs or over the computer interfaces.

Error Messages

Text error messages are shown in the Data Bars and Data Boxes of the PPM100 display. Consult the 'Error Messages' section of this chapter for more information.



Touch the Data Box and choose 'Status Information' to display an explanation of the gauge status message.

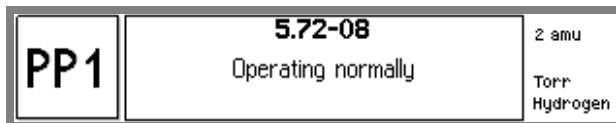

Audio Alarms

Sounds are used to draw the user's attention to potentially serious problems.

Error Status Words

Internal status words signal all status and error conditions through the computer interfaces.

RGA Error Pop-up Windows



RGA Errors are reported through pop-up windows which display RGA error codes and, in some cases, troubleshooting instructions. Consult Chapter 9 of the SRS *RGA Operation and Programming* manual to obtain troubleshooting information for all RGA error codes.

RGA Error LED

A Red LED on the back plane of the RGA Electronics Box lights up to indicate the presence of detected Errors within the RGA Head. All detected RGA Errors are prompted, and described, on the front panel of the PPM100.

RGA Connection Indicators

The status of the RGA RS-232 connection between the PPM100 and the RGA head is indicated by a connection icon at the upper right of the LCD screen.

-  The connected symbol indicates that the RS-232 connection to the RGA head is fully functional and in normal operation mode.
-  The unconnected symbol indicates that the RS-232 interface is configured for normal operation mode but that the PPM100 has failed to detect the RGA head.

P/T Indicates that the HOST RS-232 port is in Pass Through Mode.

Event Logging

All Process Control events are stored in the Process History log. Use the [History] QuickKey in the Process Control Display to trace all channel actions and debug your process control settings. Use the [Overview] QuickKey to list the state and rules for all the Process Control channels.

Remote Status Checking

Status reporting commands are available to query the RGA, Gauges and Process Control Status through the computer interfaces. Users developing their own control software should integrate status-checking commands into their programs and use them to monitor the condition of their system. Status checking and error reporting should be an integral part of any custom-built control software.

The PPM100 controller offers sophisticated error and status reporting capabilities, beyond the simple error reporting capabilities of the RGA Head.

Tip

Keep in mind that the PPM100 also offers a pass-through communication mode that can be used to query the RGA's Error and Status bytes directly through the PPM100 interface.

For More Information

Consult Chapter 6 for a complete listing of the error checking commands and status registers.

Consult Chapter 6 of the SRS *RGA Operation and Programming* manual for details on RGA error codes and status checking commands.

Interface Queues

The PPM100 buffers the most recent characters received and transmitted over the RS-232 (HOST RS-232), GPIB, USB and Web interfaces. A Queue Display, accessed through the Remote submenu of the Main Menu, shows the interface history for both transmitted and received data. Use this feature to troubleshoot communications during the development of your custom control software.

For More Information

Consult the RS-232, GPIB, USB and Web Queue menu items in Chapter 3 of this manual. Consult Chapter 6 for communications troubleshooting information.

PPM100 Error Messages

Error Messages alert PPM100 users of instrument malfunctions detected during normal operation. They are short descriptive messages (one or two words) displayed within a Data Box or Data Bar where measurements are normally displayed. Touch the Data Box and choose 'Status Information' to display a more complete description of the problem.

The following tables list all Error Messages, along with possible causes and recommended solutions.

Pressure/Voltage Display

Error Message	Cause	Solution
OVERRANGE	The Data is too large for a valid reading	Reduce the pressure or voltage in your system.
NEGATIVE	The PPM100 cannot display negative numbers in this display mode.	Rezero the controller. Choose a different display mode.
OVERLOAD	The input voltage is beyond the $\pm 12V$ range of the analog I/O port. Excessive input voltage.	Limit the voltage range of the input signal. Use a voltage divider if necessary. Reduce the pressure of the capacitance manometer connected to the port.
FAULT	There is a serious system hardware problem in the controller that needs immediate attention.	Contact SRS. Do NOT use the PPM100 until the problem is diagnosed.
RESET	There has been no data to display since the unit was turned on.	Contact SRS.
DISPLAY OFF	Pressure Display turned off	This usually means that the CM Mode has been set to Off for the Analog I/O Port.
DAC OUTPUT	The CM is connected to an analog I/O port configured as a DAC output.	Configure the capacitance manometer port as an AD input so that you can read pressures directly.
GAUGE OFF	The external Gauge is off	The voltage provided by the gauge is $<1V$, indicating an OFF condition. Note: Most compact gauges provide voltage outputs between 2 and 10V. A voltage output below 1V is interpreted as the gauge being Off.
GAUGE FAULT	The external Gauge is in a FAULT Status	The voltage provided by the gauge is $>10V$, indicating a FAULT condition. Note: Most compact gauges provide voltage outputs between 2 and 10V. A voltage output above 10V is interpreted as the gauge being in a FAULT Condition.

Error Message	Cause	Solution
WAIT	<p>The controller is computing the answer.</p> <p>Emission current is being established in the RGA</p> <p>The RGA has not returned the data requested yet.</p> <p>RS-232 cable to RGA is damaged.</p>	<p>Wait for the answer.</p> <p>Wait for the emission current to stabilize.</p> <p>Wait for the data to be returned</p> <p>Check RS-232 cable continuity or replace cable.</p>
NOT SELECTED	The gauge has not been selected.	Select the gauge.

RGA

Error Message	Cause	Solution
<p>NO RGA</p> <p>The RGA connect icon is  indicating no communication with the RGA head.</p>	<p>No RGA is connected to this PPM100.</p> <p>RGA power is off.</p> <p>RS-232 cable to RGA is damaged.</p>	<p>Connect RGA to PPM100 (see Chapter 1).</p> <p>Turn RGA power on.</p> <p>Check RS-232 cable continuity or replace cable.</p>
FILAMENT OFF	RGA Filament is turned off	<p>Turn the RGA Filament on using the FILAMENT button on the front panel.</p> <p>Or</p> <p>Set "Ionization Source=External" in the RGA Setup menu of the PPM100 if an external ion source is being used.</p>
TTL LOCKOUT	The RGA filament is turned off by the RGA_Fil_Lockout pin of the TTL Remote Control Module. The filament remains off as long as this pin is held LOW, and RGA_Remote_Enable is LOW.	Set the RGA_Fil_Lockout pin high or disable Remote Control (set RGA_Remote_Enable=High).

Basic Troubleshooting

This section documents symptoms, causes and possible solutions for some of the common problems encountered during the operation of a PPM100 controller.

Note

The problems listed below **DO NOT GENERATE Error Messages.**

Input Power

Power Problems		
Symptom	Possible Cause	Solution
LINE LED is off	No AC power available to the controller Defective internal power supply module	Check your connection to the AC power outlet. Look for defective power outlet, defective power cord or power cord not connected. If AC power is available to the controller but the LED is still off, contact SRS.

RGA

RGA		
Symptom	Possible Cause	Solution
Pressure reading is very inaccurate	Electrical leakage in the RGA feedthrough Defective electrometer circuit Electrometer drift Tube sensitivity improperly programmed Contaminated RGA probe Poor conductance in RGA's connection to vacuum system Cross-talk with other ion sources	Bakeout the RGA probe. Wash the RGA probe if no change. Contact SRS. Perform "Calibrate Electrometer" operation Reprogram the RGA's sensitivity factor (using the RGA Windows software). Bakeout and/or degas the RGA probe. Wash the RGA probe if no change. Move the RGA probe to the point-of-measure and/or increase conductance. Separate the RGA head from other ion sources such as magnetrons, ion gauges, ion pumps, ion guns, etc.

8-10 Basic Troubleshooting

RGA		
Symptom	Possible Cause	Solution
Pressure reading too low	Electrometer drift Defective electrometer circuit Contaminated RGA head Defective RGA head	Perform "Calibrate Electrometer" operation. Contact SRS. Clean RGA head. Replace/repair the RGA head.
Pressure readings erratic	RGA probe badly contaminated Improper grounding Bad electrical connection Faulty electrometer Cross-talk with other ion sources Excessive vibrations	Bakeout, and/or degas. Wash the RGA probe if no change. Perform a Proper Grounding Test (see Chapter 1). Check connection between RGA probe and ECU. Contact SRS. Turn off all other sources of ions. Separate/shield the RGA from other ionization gauges, ion pumps, etc. Isolate the vacuum system from the vibration source.
RGA filament is unusually bright as soon as emission is turned on. (Requires a viewport in the system.)	Contaminated/damaged filament Pressure is too high Defective power supply	Bakeout and/or degas the RGA probe. Try alternate filament if available. Identify and eliminate any source of contamination. Reduce the pressure at the RGA head. Contact SRS.
Degas will not turn on	RGA filament not turned on Defective RGA ECU	Turn on the RGA filament before selecting DEGAS. Contact SRS.
RGA shuts off after degas is initiated	Damaged filament Badly contaminated tube	Replace the filament. Bakeout or wash the RGA probe.
RGA not detected	PPM100 is in RS-232 Pass Through Mode	Check the Main/Remote/RS232 menu and set RGA Pass Through to Normal Operation.

Capacitance Manometer

Capacitance Manometer Problems		
Symptom	Possible Cause	Solution
Pressure reading grossly in error	Gauge contaminated or damaged	Consult your gauge manual or manufacturer for possible solutions.
	Excessive mechanical vibration	Remove the vibrations or mechanically isolate.
	Wrong full range (CMPmax) setting	Check the CM Pmax value, and adjust if necessary.
	Poor conductance in gauge's connection to vacuum system	Move the gauge to the point-of-measurement, or increase conductance.
	Gauge needs to warm up	Temperature compensated gauges need up to one hour to completely warm up.
	Controller out of calibration or faulty gauge electronics	Contact SRS.
	Wrong supply voltage	Check power supply voltage and current limit settings. Do not use the AUX $\pm 15V$ supply for heated gauges.
Gauge zero is off	Zero drifted off	Adjust the Zero calibration (using the Gauge Setup menu). Perform a Trim-Pot Zero Adjustment. Consult Chapter 3 for details.
Gauge Pmax reading is Off (Vout $\neq 10V$ when P=Pmax)	The gauge's gain calibration has drifted. This is a rare problem.	Follow the manufacturer's recommendations to adjust your gauge's calibration trim pots.
Gauge reading is too low and unresponsive to pressure changes	Gauge is unpowered	Check your cable and connections, check the current limit in your power supply, check the power supply operation.
	Gauge output circuit is faulty	Contact the gauge manufacturer.
Gauge reading is 'OVERLOAD'	The pressure output signal from the CM exceeds 12V	Reduce the pressure at the CM until it is below Pmax.

Process Control

Process Control Problems		
Symptom	Possible Cause	Solution
Channel output does not respond to input signal	Incorrect rules Bad connection Delay is too long Hysteresis is too large MassSpec Display is active (analog scan in progress)	Review the Channel Rules. Check the channel connections. Reduce the Delay setting. Reduce the Hysteresis setting. Exit the MassSpec Display.
Channel activates at wrong setpoint or time	Incorrect rule	Check the Channel Rules – Setpoint, Hysteresis and Delay settings
Relay closure does the opposite of what is expected	Wrong connection	Check the relay connection. Each SPDT relay has three connection pins, make sure you are connected to the right ones.
Relay contact opens and closes intermittently around the setpoint	Hysteresis percentage setting is too small	Increase the Hysteresis Percentage setting. Check for excessive noise in the input signal. Filter if necessary.

Analog I/O

Analog I/O Problems		
Symptom	Possible Cause	Solution
The analog output does not follow the log of the pressure of the gauge	The Analog I/O port is not configured properly.	Make sure the analog I/O port is configured as an Output and linked to the right gauge.
Analog reading is 'OVERLOAD'	The input signal exceeds $\pm 12V$ range.	Reduce the input voltage until it is between $-12V$ and $+12V$.

Maintenance

SRS RGA

The SRS RGA requires routine maintenance and occasional troubleshooting. For information consult the Maintenance chapter of the RGA's Operating Manual and Programming Reference.

PPM100 Controller

IMPORTANT

The PPM100 controller box does not have any serviceable parts and requires no scheduled maintenance.

The PPM100 is only recommended for use in a clean, dry laboratory environment. Operation in other environments may cause damage to the controller and reduce the effectiveness of the safety features.

In all cases provide adequate ventilation for the control unit to dissipate heat - ≈ 1 inch clearance around the side ventilation slots is recommended. Allow at least 6 inches at the back of the controller for cable routing. Do not mount the unit above other equipment that generates excessive heat.

The PPM100 is designed to operate over the range 0-40°C. Ambient temperatures above that value might damage the product. For optimum electrometer stability (particularly while using calibrated gauges) the control unit ambient temperature should be $25 \pm 5^\circ\text{C}$.

Touchscreen

The surface of the touchscreen should be kept free of dirt, dust, fingerprints and other materials that could degrade its optical properties. Long term contact with abrasive materials will scratch the front surface and harm image quality.

Do not operate the touchscreen with the tips of pens or sharp objects that might permanently stain or damage the screen surface.

Use a clean, non-abrasive cloth towel and a commercial window cleaner to regularly clean the screen. The cleaning solution should be applied to the towel, NOT the surface of the touchscreen. Fluid may seep behind the panel if it is not cleaned properly. Turn off the unit or activate the Clean Touchscreen (Main menu, then Screen menu) while wiping the screen's surface.

Damage Requiring Service

Caution

Do not use this product if it has unauthorized modifications. Unauthorized modifications may result in fire, electric shock and other hazards.

Do not use accessories not recommended in this manual as they may be hazardous.

Note

Within this section, the word 'product' specifically refers to the PPM100 Partial Pressure Monitor, any of its accessories, or any SRS manufactured vacuum gauge.

Contact the factory for instructions on how to return the instrument for authorized service and adjustment.

Service of this product, by Authorized Service Personnel only, may be required under any of the following conditions:

- Any cable or plug is damaged.
- The product does not operate properly even after strictly following the operating instructions.
- The product exhibits a distinct change in performance.
- A liquid has spilled inside the product.
- The product has been exposed to rain or water.
- An object has fallen into the product.
- The product has been dropped or the enclosure has been damaged.
- The product contains unauthorized modifications. Do not substitute parts or modify the product. No user-serviceable parts are inside the controller. All service and repair information in this manual is for the use of Authorized Service Personnel only.
- The repair and/or service of products exposed to vacuum systems can only be carried out if a completed Declaration of Contamination (at front of manual) has been submitted. Stanford Research Systems reserves the right to refuse acceptance of vacuum equipment where the Declaration of Contamination has not been fully or correctly completed. SRS also reserves the right to deny return authorizations for any vacuum equipment that could potentially be harmful to the personnel carrying out the repair and service of the product.