

# **MODEL FS700**

## **LORAN-C**

### **FREQUENCY STANDARD**

## **MODEL FS710**

### **Distribution Amplifier**



1290-D Reamwood Avenue  
Sunnyvale, California 94089  
Phone: (408) 744-9040 • Fax: (408) 744-9049  
email: [info@thinkSRS.com](mailto:info@thinkSRS.com) • [www.thinkSRS.com](http://www.thinkSRS.com)

Copyright © 1997 by SRS, Inc.  
All Rights Reserved.

Revision 2.5 (10/2001)



# TABLE OF CONTENTS

## FS700 LORAN-C Frequency Standard

### Condensed Information

<b>Safety and Preparation for Use</b>	iii
<b>Symbols</b>	v
<b>Specifications</b>	vi
<b>Abridged Command List</b>	viii
<b>Quick Start</b>	x

### Operation

<b>Introduction to LORAN-C</b>	1
Signal Characteristics	1
Phase Coding	3
Signal Propagation	3
Blink Transmissions	3
Additional Information	4
<b>LORAN-C Station List</b>	5
<b>FS700 Overview</b>	9
Introduction	9
Antenna	9
Signal Acquisition	9
Locking to LORAN-C	10
Signal Errors	10
<b>Front/Rear Panel Features</b>	11
Front Panel Features	11
Rear Panel Features	12
<b>Front Panel Operation</b>	14
Introduction	14
LORAN Tracking	14
Overview	14
Tracking Menu	15
GRI Selection	15
Station Selection	15
Search Mode	16
Time Constant	16
Keyboard Lock	16
Status Menu	17
Gain, Signal to Noise	17
Phase	17
Stations Found	18
Status Timing	18
Signal Quality	18

Tracking Point Monitoring	18
Notch Filters	19
Tuning the Notch Filters	19
Search Problems	20
Tracking Problems	21
Frequency Generation and Calibration	23
Frequency Menu	23
Phase Menu	23
Time Menu	25
Setup Menu	25

### Programming

<b>Programming the FS700</b>	27
Communications	27
GPIB Communication	27
Front Panel LED's	27
Data Window	27
Command Syntax	27
Programming Errors	28
Detailed Command List	28
Tracking Control Commands	28
Tracking Status Commands	30
Phase Meter Commands	31
Status Reporting Commands	33
Hardware Test Commands	34
Status Byte Definitions	35
Status Reporting	35
Serial Poll Status Byte	35
Standard Event Status Byte	35
LORAN Status Byte	36
Programming Examples	37
Microsoft C - Example 1	37
IBM Basic - Example 2	39

### Test and Calibration

<b>Troubleshooting</b>	41
Self Test Errors	41
GPIB Interface Problems	42
<b>Hardware Troubleshooting</b>	43
16-Bit DAC Test	43
RF Circuitry Test	43
Integrator Test	44

Peak Detector Test	44	Typical Specifications	75
<b>Performance Tests</b>	45	Operation	76
Introduction	45	Trouble Shooting	76
Necessary Equipment	45	Calibration	76
Tests	45	Circuit Description	76
Start Tests	45	Line Voltage Selection	76
Front Panel Test	45	Line Fuse	76
RF Bandwidth Test	46	<b>FS710 Component Parts List</b>	77
Internal Self-Tests	46	<b>PC Layout</b>	80
Notch-Filter Check	47	<b>Schematic</b>	81
10 MHz Oscillator Check	47	<b>Component Placement on PCB</b>	
Phasemeter Check	48	<b>Schematic Circuit Diagrams</b>	
<b>FS700 Performance Test Record - Scorecard</b>	49	Front End/Notch Filters	1/14
<b>Calibration</b>	50	LORAN Front End	2/14
Necessary Equipment	50	Microprocessor System	3/14
Coarse Oscillator Adjustment	50	I/O Ports and Interrupt Driver	4/14
Bandpass Filter Alignment	51	Gated Integrators	5/14
Notch Filter Alignment	53	Gated Integrator Pattern RAM	6/14
<b>FS700 Circuitry</b>		A/D, D/A Converters	7/14
<b>Circuit Description</b>	55	Clocks and Clock Outputs	8/14
Front End/ Notch Filters	55	Phase Comparator/Frequency	
LORAN Front End	55	Output	9/14
Microprocessor System	56	Front Panel LED's/Switches	10/14
I/O Ports and Interrupt Driver	57	Unregulated Power Supplies	11/14
Gated Integrators	57	Power Supply Regulators	12/14
Gated Integrator Pattern RAM	57	Spare IC's	13/14
A/D, D/A Converters	58	Active Antenna	14/14
Clocks and Clock Outputs	58		
Phase Comparators/Frequency			
Output	59		
Front Panel LED's/Switches	59		
Unregulated Power Supplies	59		
Power Supply Regulators	60		
Active Antenna	60		
<b>FS700 Component Parts List</b>	61		
<b>FS710 Amplifier</b>			
<b>FS710 – 10 MHz AGC Distribution Amplifier</b>			
Introduction	75		
Front Panel - Figure 1	75		

## SAFETY AND PREPARATION FOR USE

**WARNING:** Dangerous voltages, capable of causing death, are present in this instrument. Use extreme caution whenever the instrument covers are removed.

**WARNING:** Watch for overhead power lines when installing the FS700's antenna. Contact with power lines can be fatal.

**This instrument may be damaged if operated with the LINE VOLTAGE SELECTOR set for the wrong AC line voltage or if the wrong fuse is installed.**

### Line Voltage Selection

The FS700 operates from a 100 V, 120 V, 220 V, or 240 V nominal AC power source having a line frequency of 50 or 60 Hz. Before connecting the power cord to a power source, verify that the LINE VOLTAGE SELECTOR card, located in the rear panel fuse holder, is set so that the correct AC input voltage value is visible.

Conversion to other AC input voltages requires a change in the fuse holder voltage card position and fuse value. Disconnect the power cord, open the fuse holder cover door and rotate the fuse-pull lever to remove the fuse. Remove the small printed circuit board and select the operating voltage by orienting the printed circuit board to position the desired voltage to be visible when pushed firmly into its slot. Rotate the fuse-pull lever back into its normal position and insert the correct fuse into the fuse holder.

### Line Fuse

Verify that the correct line fuse is installed before connecting the line cord. For 100 V/120 V, use an 1 Amp fuse and for 220 V/240 V, use a 1/2 Amp fuse.

### Line Cord

The FS700 has a detachable, three-wire power cord for connection to the power source and to a protective ground. The exposed metal parts of the instrument are connected to the outlet ground to protect against electrical shock. Always use an outlet which has a properly connected protective ground.

### Antenna

The FS700's vertical antenna should be installed on the roof of a building. Watch for power lines when installing the antenna.

### Furnished Accessories

- Power Cord
- Operating Manual

### Environmental Conditions

#### OPERATING

Temperature: +10° C to +40° C  
(Specifications apply over +18° C to +28° C)  
Relative Humidity: <90% Non-condensing

#### NON-OPERATING

Temperature: -25° C to +65° C  
Humidity: <95% Non-condensing

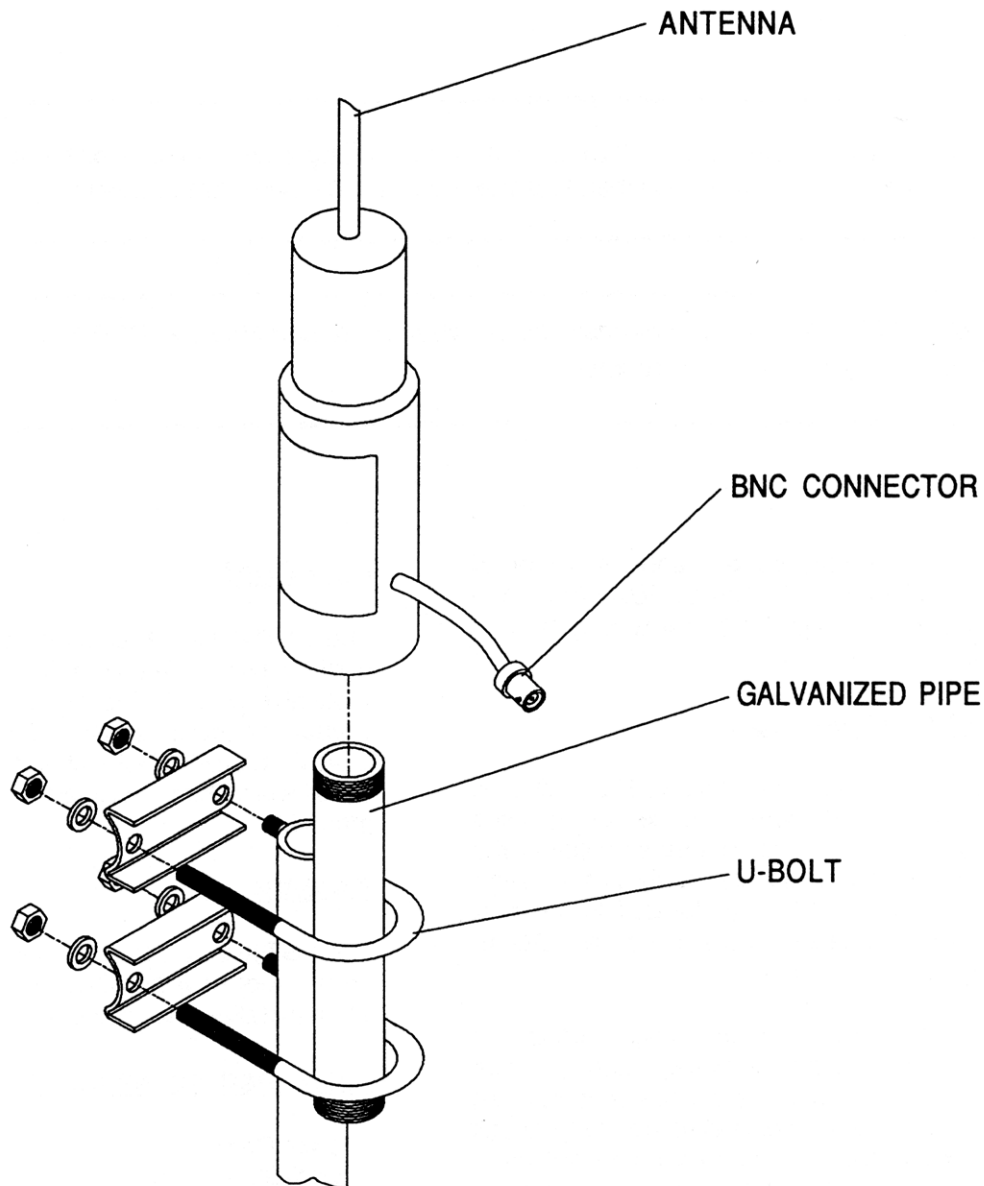

### **FS700 Antenna Installation Instructions:**

New FS700 Antenna Installation Instructions:









The new style PVC base LORAN-C antenna used with the FS700 LORAN Receiver comes with a 6" galvanized pipe nipple and 2 U-bolt clamps for mounting. After securing galvanized pipe with U-bolts, the antenna base can be screwed onto the pipe nipple and the BNC connector can be connected to the lead-in cable. The piece of supplied special heat shrink tubing should be applied over the cable connection and heated with a heat gun or other heat source to weatherproof the connection.

The new antenna does not have an internal attenuator as with the old style antennas. If excessive signal strength is encountered, consult the factory.

### **!!NOTE ON GROUNDING AND LIGHTNING PROTECTION!!**

All metal antenna attachments should always be connected to a good earth ground. In areas where lightning is encountered, a lightning arrester(s) should be used in the antenna lead-in cable.

## Symbols you may find on SRS products.

Symbol	Description
	Alternating current
	Caution - risk of electric shock
	Frame or chassis terminal
	Caution - refer to accompanying documents
	Earth (ground) terminal
	Battery
	Fuse
	On (supply)
	Off (supply)

# SPECIFICATIONS

## Receiver Specifications

<b>Sensitivity</b>	Will lock with signal-to-atmospheric noise level of -10 dB or better.
<b>LORAN Output</b>	Filtered and gain controlled antenna signal, typically 6 V peak-to-peak.
<b>Station Search</b>	All available stations pre-programmed. Auto-Seek finds and tracks strongest station.
<b>Notch Filters</b>	6 adjustable 30 dB notch filters, 3 at 40 - 90 kHz, 3 at 110 - 220 kHz.
<b>Antenna</b>	8 Foot Active Whip with 30 dB switchable attenuator, bandpass filter, and FET preamp in weatherproof housing.

## Frequency Specifications

### **Frequency Stability**

Long Term	10 <sup>-12</sup> , the same as LORAN-C transmitter Cesium clock.
Short Term	10 <sup>-10</sup> , standard oscillator. 10 <sup>-11</sup> , low phase noise option.

**10 MHz Outputs** 4 outputs, 1 Volt peak-to-peak sine wave into 50 W.

### **Internal Oscillator**

	<u>Standard</u>	<u>Option/01</u>
Frequency	10.000 MHz	10.000 MHz
Type	AT Cut Ovenized	SC Cut Ovenized
Aging	5 x 10 <sup>-10</sup> per day	5 x 10 <sup>-10</sup> per day
Allan Variance (1 s)	5 x 10 <sup>-11</sup>	5 x 10 <sup>-12</sup>
Stability 0-50° C	0.005 ppm	0.005 ppm
Phase Noise (dBc)		-120 dBc, 10 Hz offset from carrier -155 dBc, 100 Hz offset from carrier -165 dBc, 1 kHz offset from carrier

## Phasemeter Specifications

<b>Frequency Output</b>	0.01 Hz to 10 MHz in 1, 2.5, 5 sequence, TTL level. Can be 50 Ω terminated.
<b>Oscillator Input</b>	1 kΩ, 0.5 V peak-to-peak minimum level. 50 Volts max.



<b>Phase Output</b>	0.01 V/degree, 0 to $\pm 360^\circ$ . Output proportional to phase difference between OSC IN and FREQUENCY OUTPUT for frequencies between 100 kHz and 10 MHz.
<b>Phase Resolution</b>	3°
<b><u>Interface</u></b>	
<b>GPIB</b>	IEEE - 488 compatible interface. All instrument functions may be controlled.
<b><u>General</u></b>	
<b>Operating</b>	0 to 50° C.
<b>Power</b>	100, 120, 220 or 240 VAC +5% - 10%, 50/60 Hz, 50 Watts.
<b>Dimensions</b>	17" x 17" x 3.5". Rack mounting hardware included.
<b>Weight</b>	14 lbs.

## ABRIDGED COMMAND LIST

Commands which may be queried have a ? in parentheses (?) after the mnemonic. The ( ) are not sent. Commands that may **only** be queried have a '?' after the mnemonic. Commands which **may not** be queried have no '?'. Optional parameters are enclosed by {}. i and j are integers.

### Tracking Control Commands

<b>AUTO(?) {i}</b>	Sets the search mode to AUTO (i = 1) or Manual (i = 0).
<b>FLLT(?) {i}</b>	Sets the receiver time constant.
<b>GRIP(?) {i}</b>	Sets the GRI to i micro seconds.
<b>STOP</b>	Stops LORAN station tracking.
<b>STRT</b>	Starts station acquisition.
<b>STTN(?) {i}</b>	Sets the station to be tracked.

### Tracking Status Commands

<b>GAIN?</b>	Returns the current receiver gain.
<b>INFO? i</b>	Returns station search information.
<b>LFOS?</b>	Returns instantaneous frequency correction.
<b>LPHA?</b>	Returns current phase of internal clock relative to LORAN-C signal.
<b>LSTA?</b>	Returns the index of the station being tracked.
<b>NSTA?</b>	Returns the number of stations found during search.
<b>STON?</b>	Returns the noise margin of the station being tracked.
<b>TIME(?) {h,m,s}</b>	Sets/reads the time of day.
<b>TLCK?</b>	Returns the amount of time the FS700 has been locked.
<b>TULK?</b>	Returns the length of the last unlock period.

### Phasemeter Commands

<b>DLTF?</b>	Returns the frequency offset between the FREQUENCY OUTPUT and the OSC IN BNC's.
<b>FREQ(?) {i}</b>	Sets the frequency of the FREQUENCY OUTPUT.
<b>PHSE?</b>	Returns the phase difference between the FREQUENCY OUTPUT and the OSC IN BNC.

### Status Reporting Commands

<b>*CLS</b>	Clears all status registers.
<b>*ESE(?) j</b>	Sets/reads the standard status byte enable register.
<b>*ESR? {j}</b>	Reads the standard status register, or just bit j of register.
<b>*IDN?</b>	Returns the device identification .
<b>*PSC(?) j</b>	Sets the power on status clear bit. This allows SRQ's on power up if desired.
<b>*RST</b>	Clears instrument to default settings.
<b>*SRE(?) j</b>	Sets/reads the serial poll enable register.
<b>*STB? {j}</b>	Reads the serial poll register, or just bit n of register.
<b>SENA(?) j</b>	Sets/reads the LORAN status enable register.

**STAT? {j}** Reads the LORAN status register, or just bit n of register.

### **Hardware Test Commands**

(NOTE: These commands are not needed during normal operation.)

<b>*TST?</b>	Starts self-test and returns status when done.
<b>\$ASC i</b>	Sets antenna input source. i = 0 = antenna, i = 1 = cal.
<b>\$DAT?</b>	Reads In phase and Quadrature gate data.
<b>\$GAT i</b>	Sets test gate patterns.
<b>\$INT? i</b>	Reads integrator data.
<b>\$POS i</b>	Sets gate position.
<b>ATTN i</b>	Sets the attenuators to value i.
<b>OSCF(?) i</b>	Sets the oscillator DAC to i.

## QUICK START INSTURCTIONS

When installing the FS700 for the first time, it is recommended that the following procedure be carried out. If a problem is encountered, please read the detailed discussion on instrument operation (pages 1-46).

- 1) Make sure that the correct line voltage has been selected on the rear panel power entry module.
- 2) Install the antenna according to the instructions on pages iv and 9 of this manual.
- 3) While holding the **BSP** key down, turn the front panel power switch of the FS700 to the **ON** position. After a second or two, release the **BSP** key. This procedure will initialize all data in the FS700's RAM. Notice that the **OVEN** LED in the **STATUS** section is on. It will take 20 minutes for the internal 10 MHz oscillator to stabilize. At that point, the **OVEN** LED will turn off. (It is not necessary to wait for the **OVEN** LED to turn off before proceeding.)
- 4) Press the **TRACKING** menu button on the front panel. Using the **FIELD** button, position the cursor the GRI field and type in the appropriate GRI for your area. (Note that the GRI can also be selected by scanning the **LOCATION** field. This is done by using the **ARROW** keys.)
- 5) Now you must wait until the **OVEN** LED goes off (approximately 20 minutes). When the **OVEN** LED goes off, the **SEARCH** LED will immediately turn on and the FS700 will start acquiring the LORAN signal. The search process will take between 15 and 40 minutes. After the FS700 has successfully locked to the LORAN signal, the **LOCK** LED will turn on. Now the FS700 is ready for operation.

## INTRODUCTION TO LORAN-C

LORAN-C is an accurate navigation system that is maintained by the U.S. Coast Guard (LORAN stands for Long Range Navigation). A receiver that measures the arrival times of the signals from three LORAN stations can determine its position with an accuracy of about 1000 feet at a range of over 1000 miles. Because of the desire for good long range position accuracy, the frequency and transmission time of each LORAN transmitter is controlled by a set of Cesium clocks or Hydrogen masers whose frequency accuracy is maintained by the U.S. Naval Observatory. Because the timing characteristics of the LORAN transmission are so tightly controlled, a receiver measuring the signal from a single LORAN station can produce a very accurate frequency output that is traceable to the U.S. Naval Observatory and NIST. LORAN-C transmissions are also highly reliable. The stations are functional more than 99% of the time and signal errors usually last only a few minutes.

### Signal Characteristics

Signal LORAN-C stations transmit a pulsed signal at a carrier frequency of 100 kHz. This frequency was chosen for stable propagation characteristics and low ground wave attenuation. The transmissions of the various stations are differentiated by the timing of their pulses. The LORAN transmitters in a specific geographical region are arranged in groups of at least three (the minimum number needed to establish position) to at most 6 stations called chains. The chains are differentiated by the repetition rate of the pulses transmitted by the stations in the chain. This rate is called the Group Repetition Interval, or GRI. For example, the U.S. West Coast chain has a GRI of 99400  $\mu\text{s}$  and each station in that chain (4) will transmit its signal once every 99400  $\mu\text{s}$ . If the receiver synchronizes its timing with the desired GRI, only stations in that GRI will produce a stable signal. Each chain has a master station (labelled "M") and up to four secondary stations (labelled "V", "W", "X", "Y", and "Z"). Once every GRI, each station will transmit a group of eight pulses at the 100 kHz carrier frequency. Each pulse is about 250  $\mu\text{s}$  long, and the pulses are separated by exactly 1 ms. The master station has a ninth pulse that is transmitted 2 ms after the eighth pulse. This ninth pulse identifies the station as the master. The master station always transmits first in the GRI followed by each

Figure 1

Transmission of LORAN Signals During a GRI

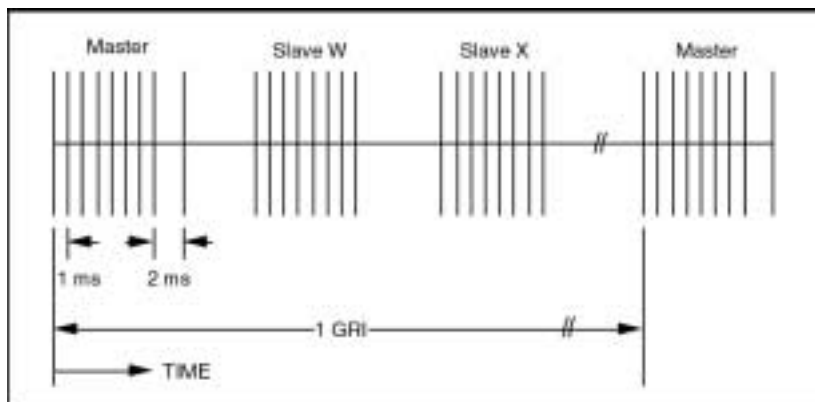

secondary station in a prescribed order. The signals are transmitted so that the pulse groups will never overlap within the reception range of the stations. This is shown in Figure 1. The receiver determines its position from the time differences between the transmissions from each station, and the known positions of the transmitters. If the master station cannot be received, there is no way to identify the stations and also no way to determine the receiver's position.

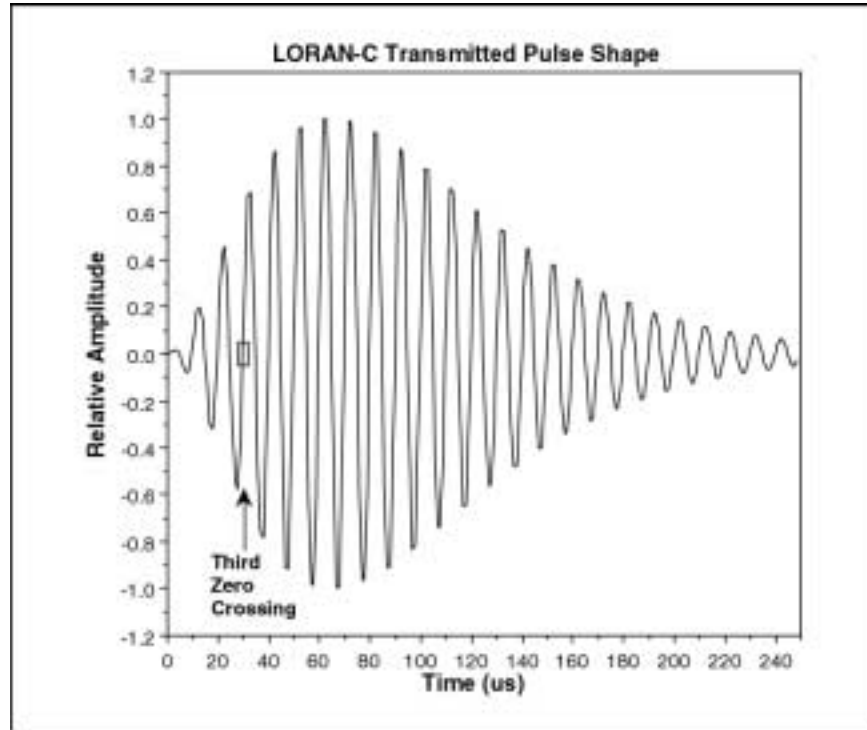

Graph 1  
Shape of the Transmitted  
LORAN-C Pulse

The Coast Guard controls the accuracy of the LORAN-C system by precisely controlling the transmitter carrier frequency and the pulse emission time. The pulse emission time is controlled by accurately setting the emission time of the third positive zero crossing of the LORAN rf pulse. This point is called the PULSE TIME REFERENCE (PTR), and was chosen as a compromise between adequate signal-to-noise ratio and freedom from skywave interference (discussed below). The shape of the LORAN pulse is shown in Graph 1. By carefully tracking the PTR over long time intervals it is possible to extract the inherent frequency accuracy of the LORAN transmitter's Cesium clock. This is the function of the FS700 LORAN-C Frequency Standard. The FS700 will produce a frequency output with the same long-term accuracy as a USNO controlled Cesium clock as long as a single station in any GRI is receivable.

## Phase Coding

LORAN transmissions are Phase Coded to minimize the effects of random noise, CW signal interference, and skywave interference. Some of the pulses in the eight pulse group are transmitted with the carrier signal inverted with respect to the rest of the pulses. That is, some pulses are transmitted with the first cycle of the pulse starting by going negative instead of positive. The phase code repeats in a two GRI period called a Frame. A receiver, such as the FS700, that takes phase coding into account will cancel any interference that occurs on an interval longer than a frame. Also, the phase coding is arranged so that any long delayed skywave interference will also be cancelled. The two GRI pulse groups within a frame are called Group A and Group B and have different phase codings. Additionally, master station frames have a different phase coding than secondary station frames. The phase codings for the various frames are shown in Figure 2.

Figure 2

Phase Codings of Master  
And Secondary Stations

<u>Group</u>	<u>Master</u>		<u>Secondary</u>
A	++--+--+	+	+++++---
B	+-----+	-	+--+-----

## Signal Propagation

The transmitted signal from a LORAN transmitter is split into two parts: the groundwave which travels parallel to the surface of the earth, and the skywave, which travels upward through the atmosphere, is reflected by the ionosphere, and returns to earth. Because the height of the ionosphere depends on the time of day, the season, and solar activity, the skywave propagation path and the propagation delay are very unstable. This makes the skywave transmission less than ideal for accurate timing. The groundwave transmission does not suffer these problems and is a very stable source of timing information. However, the groundwave signal is rapidly attenuated by the atmosphere and suffers contamination from the skywave signal which arrives slightly later in time. These considerations limit the groundwave reception range of the LORAN signal to about 1500 miles. At this range the skywave interference will never disturb the position of the PTR.

## Blink Transmissions

Occasionally a LORAN transmitter will malfunction so that its transmitted signal is no longer accurate. When this occurs the master station and the affected secondary station begin blink transmissions. The master station will blink its ninth pulse in a coded pattern indicating which secondary is bad, while the secondary station will blink its first two pulses in 0.25 seconds on, 3.75 seconds off pattern. The other pulses in the transmission are unaffected. By checking for blink the FS700 is able to ensure that it is locked to a healthy transmitting station.

## Additional Information

More detailed information may be obtained from:

- 1) United States Naval Observatory, Time Services Division  
34 Massachusetts Ave.  
Washington, DC 20390  
(202) 653-1507

Ask to be placed on the LORAN-C chain information mailing list.  
LORAN-C station propagation delays may also be obtained from:

- 2) United States Coast Guard Headquarters  
Washington, D.C. 20593  
(202) 267-0283

The LORAN-C specifications may be obtained.

Publication numbers:

LORAN C User Handbook COMDTINST M16562.3  
Specification of the LORAN C Transmitted Signal COMDTINST  
M16562.4



<u>Chain</u>	<u>GRI</u>	<u>Station</u>	<u>Transmitter_Location</u>	<u>Chain</u>	<u>GRI</u>	<u>Station</u>	<u>Transmitter_Location</u>
West Coast USA	99400 µs	M W X Y	Fallon, Nevada, USA George, Washington, USA Middletown, California, USA Searchlight, Nevada, USA	Newfoundland East Coast	72700 µs	M W X	Comfort Cove, Canada Cape Race, Canada Fox Harbor, Labrador, Canada
Canadian West Coast	59900 µs	M X Y Z	Williams Lake, BC, Canada Shoal Cove, Alaska, USA George, Washington, USA Port Hardy, BC, Canada	Bo	70010 µs	M W X	Bo, Norway Jan Mayen, Norway Berlevag, Norway
North Central USA	82900 ms	M W X Y	Havre, Montana, USA Baudette, Minnesota, USA Gillette, Wyoming, USA Williams Lake, BC, Canada	Ejde	90070 µs	M W X Y Z	Ejde, Faeroe Island, Denmark Jan Mayen, Norway Bo, Norway Vaerlandet, Norway Loop Head, Ireland
South Central USA	96100 ms	M V W X Y Z	Boise City, Oklahoma, USA Gillette, Wyoming, USA Searchlight, Nevada, USA Las Cruces, New Mexico, USA Raymondville, Texas, USA Grangeville, Louisiana, USA	Lessay	67310 µs	M X Y Z	Lessay, France Soustons, France Loop Head, Ireland Sylt, Germany
Great Lakes	89700 µs	M W X Y Z	Dana, Indiana, USA Malone, Florida, USA Seneca, New York, USA Baudette, Minnesota, USA Boise City, Oklahoma, USA	Sylt	74990 µs	M X Y	Sylt, Germany Lessay, France Vaerlandet, Norway
Southeast USA	79800 µs	M W X Y Z	Malone, Florida, USA Grangeville, Louisiana, USA Raymondville, Texas, USA Jupiter, Florida, USA Carolina Beach, NC, USA	French SNR	89400 µs	M X	Lessay, France Soustons, France
Northeast USA	99600 µs	M W X Y Z	Seneca, New York, USA Caribou, Maine, USA Nantucket, Massachusetts, USA Carolina Beach, NC, USA Dana, Indiana, USA	Mediterranean Sea	79900 µs	M X Z	Sellia Marina, Italy Lampedusa, Italy Estariit, Spain
Canadian East Coast	59300 µs	M X Y Z	Caribou, Maine, USA Nantucket, Mass., USA Cape Race, Canada Fox Harbor, Labrador, Canada	Saudi Arabia North	70300 µs	M V W X Z	Afif, SA Salwa, SA Al Khamasin, SA Ash Shaykh Humayd, SA Al Muwassam, SA
				Saudi Arabia South	88300 µs	M W X Y Z	Al Khamasin, SA Salwa, SA Afif, SA AshShaykh Humayd, SA Al Muwassam, SA

<u>Chain</u>	<u>GRI</u>	<u>Station</u>	<u>Transmitter Location</u>	<u>Chain</u>	<u>GRI</u>	<u>Station</u>	<u>Transmitter Location</u>
Western Russia	80000 µs	M	Bryansk, Russia	China East Sea	83900 µs	M	Xuancheng, PRC
		W	Petrozvodsk, Russia			X	Raoping, PRC
		X	Solnim, Russia			Y	Rongcheng, PRC
		Y	Simferopol, Ukraine				
Z	Syzran, Russia						
Eastern Russia	79500 µs	M	Aleksandrovsk, Russia	China South Sea**	67800 µs 67300 µs	M	Hexian, PRC
		W	Petropavlo, Russia			X	Raoping, PRC
		X	Ussuriisk, Russia			Y	Chongzuo, PRC
		Y	Kurilsk, Russia\				
Z	Ohotosk, Russia						
East Asian	99300 µs	M	Pohang, Korea	Bombay	60420 µs	M	Dhrangadhr, India
		W	Kwang-Ju, Korea			W	Veraval, India
		X	Gesashi, Okinawa			X	Billamora, India
		Y	Nijjima, Japan				
Z	Ussuriisk, Russia						
Northwest Pacific	89300 µs	M	Nijjima, Japan	Calcutta	55430 µs	M	Balasure, India
		W	Gesashi, Okinawa, Japan			W	Diamond Harbour, India
		X	Marcus Island, Japan			X	Patpur, India
		Y	Tokatibutto, Hokkaido, Japan				
Z	Pohang, Korea						
Russian –American	59800 µs	M	Petropavlo, Russia				
		X	Attu, Alaska, USA				
		Y	Aleksandrovsk, Russia				
North Pacific	99900 µs	M	Saint Paul, Pribilof Is., Alaska, USA				
		X	Attu Alaska, USA				
		Y	Point Clarence, Alaska, USA				
Z	Narrow Cape, Alaska, USA						
Gulf of Alaska	79600 µs	M	Tok, Alaska, USA				
		X	Narrow Cape, Alaska, USA				
		Y	Shoal Cove, Alaska, USA				
		Z	Port Clarence, Alaska, USA				
China North Sea	74300 µs	M	Rongcheng, PRC				
		X	Xuancheng, PRC				
		Y	Helong, PRC				

\*\* Broadcasting on two different GRI

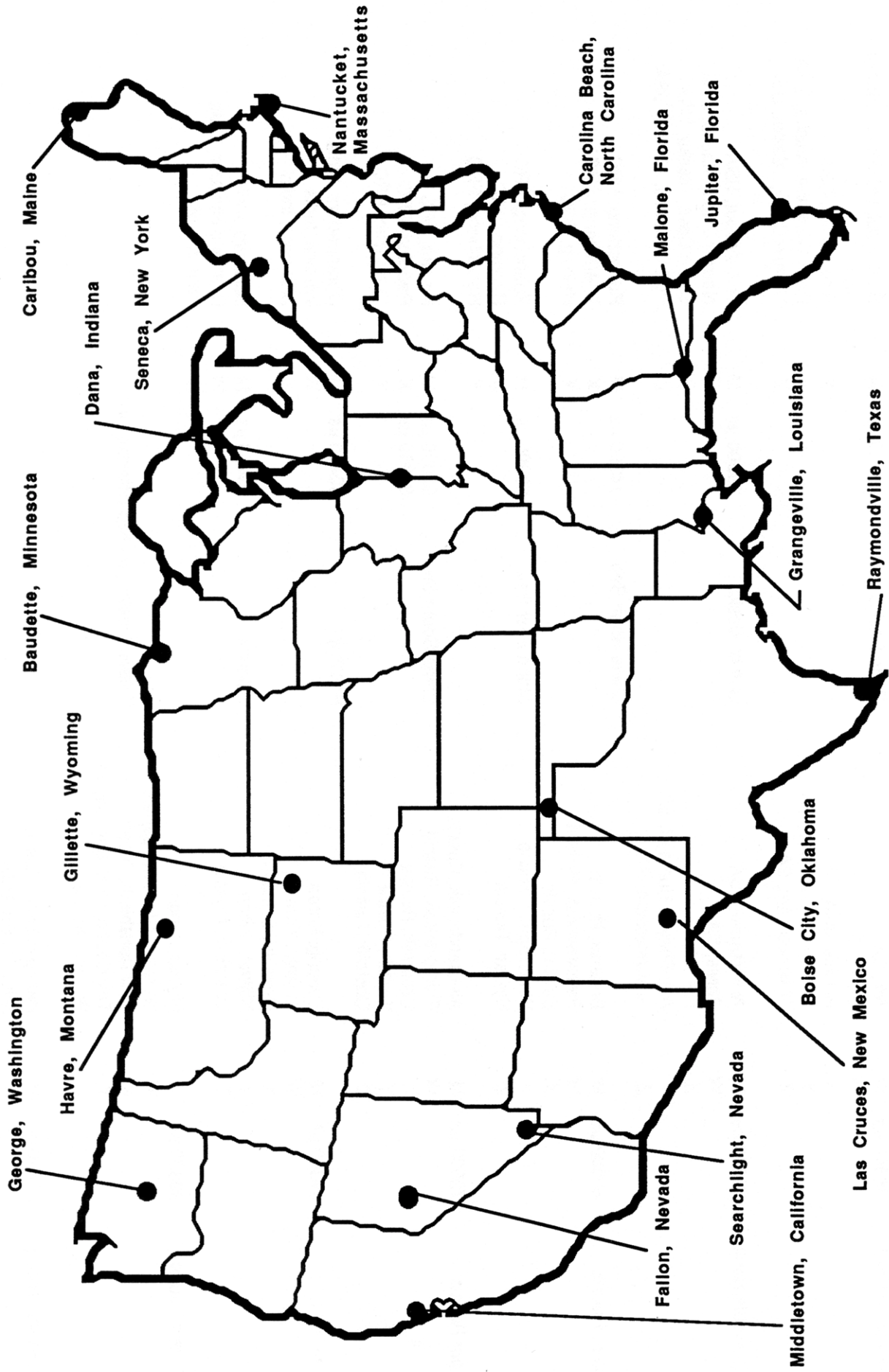

**CONTINENTAL UNITED STATES LORAN-C TRANSMITTER LOCATIONS**

*LORAN-C transmitter locations and reception range*

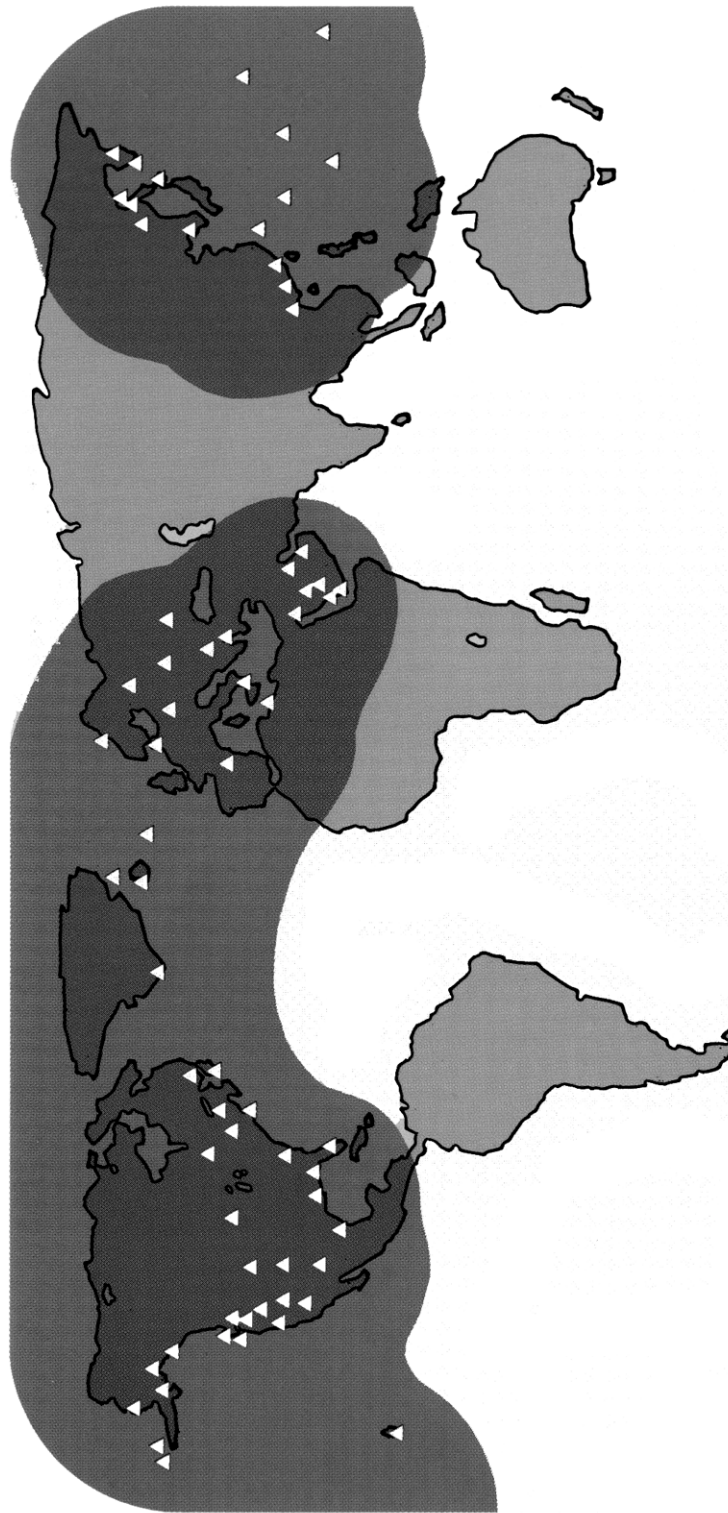

# FS700 OVERVIEW

## Introduction

The FS700 LORAN-C Frequency Standard produces a highly stable and accurate 10 MHz output by locking an internal crystal oscillator to the Cesium clock controlled LORAN-C radio transmission. The FS700 system consists of a receiver, containing amplifiers, filters, and data acquisition circuitry, and a remote antenna, with an internal preamplifier. Data acquisition circuitry allows the FS700 to frequency lock its internal oscillator to the third positive zero crossing of the LORAN-C transmission. In addition to providing an ultra-stable 10 MHz output, the FS700 also provides a user selectable TTL compatible frequency output in the range of 0.01 Hz to 10 MHz in a 1, 2.5, 5 sequence. An internal phasemeter circuit allows precise frequency calibrations of other oscillators in the range of 100 kHz to 10 MHz.

## Antenna

The FS700 should be used with the supplied antenna. Do not use another antenna because the antenna box contains filter and amplifier circuits that are necessary to the FS700. Mount the antenna outside, vertically, and preferably on the roof of a building. Connect the antenna to the FS700 with shielded cable up to 1000 feet long. Use either 50 or 75 ohm cable, since the impedance of the cable is not critical. A 100 foot, 50 ohm cable is supplied with the FS700.

## Signal Acquisition

After the user chooses and enters the desired GRI, the FS700 will acquire the LORAN-C signal (the SEARCH LED will turn on). First, automatic gain control (AGC) software adjusts the receiver gain so that the signal at all points in the GRI is at full scale (about 6 V pk-pk at the LORAN OUT connector). Next, the entire GRI is searched for the presence of LORAN pulses. After the pulses are found, and the stations identified, the desired station is chosen. This station may be selected automatically to be the largest signal detected, or the user may enter a specific station of choice. After the station is chosen the receiver identifies and matches the phase coding of the selected station.

The FS700 then begins to frequency lock to the entire pulse envelope of the selected station. This initial frequency locking removes any initial gross frequency offset (up to  $2 \times 10^{-7}$ ) and allows more time for the determination of the third zero crossing position. When the frequency offset has been reduced to better than  $1 \times 10^{-9}$ , the phase offset between the internal oscillator and the LORAN signal is set to zero and the frequency lock is terminated. The FS700 then identifies the location of the third zero crossing of the LORAN pulse. After the third zero crossing has been located, the frequency lock is restarted to lock to the third zero crossing position. At this point the FS700 enters lock mode (the LOCK LED will turn on) and begins tracking the third zero crossing.

The entire search process takes between 15 and 40 minutes depending on the signal-to-noise ratio of the station selected.

It is important to understand that at large distances (>1000 miles) from the LORAN transmitter, the LORAN skywave signal can be many times larger than the groundwave signal. The FS700 can detect and correctly handle this condition until the skywave is about 5 times the groundwave amplitude. At this point, the FS700 will most likely lock to the skywave. This results in poor long term stability because of the diurnal shifts in the skywave timing. If this occurs, a different station should be chosen.

### **Locking to LORAN-C**

Once in LOCK the FS700 keeps the frequency difference between the internal oscillator and the LORAN transmission at a minimum. This is accomplished by using a software frequency-locked loop (FLL). The frequency-locked loop adjusts the internal oscillator's frequency so that the frequency difference at all times is zero. This is different than a phase-locked loop (PLL). A PLL attempts to always keep the phase difference at zero, and may introduce a large instantaneous frequency offset to change the phase. Thus, a FLL will have better phase noise and short-term stability than a PLL. The time constant of the FS700's FLL is set according to the signal-to-noise ratio of the signal, and is generally about 2000- 5000 GRI. The FS700 also has an auxiliary PLL that keeps the phase difference between the FS700 and the LORAN signal small. The time constant for the PLL is much longer than the FLL time constant, and has no effect on short-term stability (the frequency offset due to the PLL averages to zero and is rarely instantaneously larger than  $1-2 \times 10^{-11}$ ).

### **Signal Errors**

During locking, the FS700 monitors the received signal and checks for error conditions. If an error is detected, the FS700 will halt its FLL (to prevent erroneous frequency adjustments) and wait. If the error condition goes away within 20 minutes, the FLL will restart and will continue as before. If the error does not go away, one of two things may happen. If the search mode is set to manual, the FS700 will terminate its lock. If the search mode is set to auto, the FS700 will attempt to reacquire a station. If the station selection is set to a specific station (not auto station selection), the FS700 will continue to try to acquire the station selected until the station returns to health.

# FRONT / REAR PANEL FEATURES

## Front Panel Features

- 1) **Power Switch**                      Pressing the power switch turns the FS700 on and off. In STBY position only, the ovenized oscillator is on. This minimizes warm-up time.
  
- 2) **Numeric Keypad**                    The numeric keypad allows entry and modification of parameters in the FS700's menus. Data can be entered in two modes depending on the menu item displayed. In numeric mode (NUM LED on), data is entered as a number with the keypad. The entry is terminated using the execute (EXC) key. Typographical errors may be corrected using the backspace (BSP) key. Pressing BSP with no number displayed will cause the FS700 to return to the previous value. In cursor mode (<> LED on) a menu item is modified pressing the up and down arrow keys (8 and 2). If neither the NUM or <> LED's are lit, then the selected item may not be modified.
  
- 3) **Field Key**                            In many menus, several selections are displayed. A flashing cursor denotes the modifiable item. Pressing the FIELD key causes the cursor to cycle through the available choices. If the FS700 is in GPIB remote mode, pressing the FIELD key returns the unit to local mode.
  
- 4) **Menu Keys**                          The menu keys control which menu is displayed. Several menus have more than one screen of data. The various screens of data may be displayed by repeatedly pressing the associated menu key.
  
- 5) **Status LED's**                        The 5 status LED's indicate the current status of the FS700.

<u>LED</u>	<u>Meaning</u>
LOCK	The FS700 locks to and tracks a station.
SEARCH	The FS700 searches for a station.
ERROR	An error has been detected. A relevant error message will also be displayed. These errors can be signal errors, command programming errors, etc.
OVEN	The oven LED is on at power-up which indicates the internal oven may be cold. The LED stays on for 20 minutes, and AUTO station search does not begin until this warm-up period is over. This LED is lit when the oscillator uses up more than 75% of its tuning range, (about $\pm 3$ Hz).
ANT	This LED indicates the antenna is faulty.

- 6) **LCD Display**                        The 32 character by 2 line LCD display shows menu items and informational messages. If the displayed message is not a menu item,

it is either an error or an informational message. To retrieve the menu display, just press any key.

- 7) LORAN Output** This BNC outputs the amplified and filtered antenna signal. This may be used in conjunction with the rear panel GRI SYNC and GATE outputs to view the receiver's tracking point. The output is about 6 V pk-pk and will drive a high impedance load.
- 8) Frequency Output** This connector can be set to output a TTL level signal (2.5 V into 50 ohms) at a frequency between 0.01 Hz and 10 MHz in a 1, 2.5, 5 sequence. This output may be terminated into 50 ohms.
- 9) Oscillator Input** This is the input to the FS700's internal phasemeter. The input signal to the phasemeter should have the same frequency as the FREQUENCY OUTPUT. The input has a 1 kohm input impedance and requires a signal level of about 300 mV pk-pk. This input is protected to 100 VDC and 40 VAC.
- 10) Phase Output** This is the phasemeter analog output. The output voltage is proportional to the phase difference between the OSCILLATOR INPUT and the FREQUENCY OUTPUT with a coefficient of proportionality of 0.01 V/degree. This output has a range of  $\pm 360$  degrees ( $\pm 3.6$  V) and expects a high impedance load.

## **Rear Panel Features**

- 1) Power Entry Module** The power entry module contains the FS700's fuse and the line voltage selection card. Be sure that the fuse rating matches that listed on the rear panel and that the line voltage is set to the local value. To set the line voltage: remove the power cord, remove the fuse, remove the voltage selector card from the power entry module, insert the voltage selector card so that the desired line voltage is visible through the clear plastic window, replace the fuse with a correct rated fuse for the line voltage selected, and reconnect the power cord.
- 2) IEEE-488 Connector** This connector can be used with any standard IEEE-488 (GPIB) cable to allow computer control of the FS700.
- 3) GRI SYNC Output  
Gate Output** These two outputs may be used in conjunction with the front panel LORAN OUTPUT to view the FS700's tracking point. Both outputs provide TTL level outputs and may have a 50 ohm termination. The GRI SYNC output provides a negative going pulse at the start of each GRI. When the receiver is in LOCK (LOCK LED on) this pulse occurs 500  $\pm$ 5 ms before the receiver tracking point, and the GATE output brackets the third zero crossing point with a negative going pulse. These outputs may be used with an averaging digital oscilloscope (such as HP 54501A) to view the Loran pulse tracking point. This procedure is detailed in the tracking section of this manual.



- 4) 10 MHz Outputs**                      These four outputs provide a 1 V pk-pk 10 MHz output when terminated into 50 ohms. These outputs are individually buffered and are short-circuit protected.
  
- 5) Lock Output**                         This is a TTL compatible output that is high when the receiver is locked (LOCK LED on). This output is a transistor with a 10 kohm pull-up resistor. This output may be wire-or'd with other similar outputs as long as the current sink capability is greater than 0.5 mA.
  
- 6) Antenna Input**                        This is the connector for the remote antenna. The antenna cable may be up to 1000 ft long. The FS700 must be used with the antenna that is supplied.
  
- 7) RS232 Connector (Optional)**        This connector is used for RS232 communication.

# FRONT PANEL OPERATION

## Introduction

The parameters controlling the operation of the FS700 are displayed and adjusted in a set of six menus. Each menu may have one or more screens (two line displays) of data. Each screen may contain one or more field (adjustable parameter). Pressing a menu button displays that menu. The screens that belong to a menu may be displayed by repeatedly pressing the menu button. The field that is adjustable is denoted by a flashing cursor bar. The various fields may be selected by pressing the FIELD key.

The data entry mode for each field is indicated by the mode LEDs above the field key. If the NUM LED is lit the data is entered in numeric format using the keypad. Pressing the EXC key terminates the entry. Errors are corrected using the backspace (BSP) key. If the <> LED is lit the field is changed with the cursor keys (up and down arrow keys). If neither LED is lit the display may not be changed.

Occasionally, an error or informational messages will be displayed on the LCD display. The display may be returned to the normal menu display by pressing any key.

## LORAN Tracking

The TRACKING and STATUS menus control the FS700's tracking of a LORAN-C station. Adjustable tracking parameters are set in the TRACKING menu, while tracking status is displayed in the STATUS menu.

## Overview

Most of the FS700's operation is completely automatic. First, choose a GRI and enter it into the FS700. Refer to the LORAN chain map to choose a GRI that has stations near the receiver. Then, LORAN-C station selection, acquisition, and tracking can begin. Station selection and search mode may be either manually or automatically controlled.

Station selection is the process of choosing a specific station in the GRI for tracking. In AUTO station selection, the FS700 will choose and track the station with the largest signal strength. AUTO selection is the FS700's default mode, and is recommended for general use. The FS700 may be set to track a specific station in the GRI. If the master station is not detected there is no way to identify the stations and manual station selection will fail. AUTO selection will pick the largest signal even in the absence of the master.

The FS700's search mode controls the starting and stopping of searches, and recovery from signal errors. In AUTO mode the FS700 will begin a search anytime that it is unlocked from a station. While in MANUAL, the searches must be started by pressing the EXC key. The FS700's default is AUTO. After power-on, an AUTO search will begin after the oven oscillator warm-up period expires (the OVEN LED goes off). A MANUAL search may be started at any time. However, if the

oscillator is not fully warmed up the search may fail. When in AUTO, if a signal error forces the FS700 to terminate locking, the FS700 will automatically start a new search. While in MANUAL, a new search must be started by pressing the EXC key.

GRI: <u>99400</u> $\mu$ s      Station: X Location: Middletown, CA USA
---

### **Tracking Menu**

The first screen has three adjustable parameters and is used to set the station that the FS700 is to track. If the FS700 is tracking a station, changing any of these parameters will cause the FS700 to unlock. To prevent accidental unlocks, a warning message requiring confirmation of the change will be displayed.

### **GRI Selection**

The first field is the GRI to which the FS700 is to lock. Set the GRI to a value appropriate to the location of the receiver by referring to the LORAN chain map to select the GRI for the nearest stations. The GRI must be set to a value between 40000 and 99990 ms in steps of 10 ms.

### **Station Selection**

Station selection is set with the second field. Adjust this setting with the up and down arrow keys. The default setting is "AUTO", and the FS700 will automatically choose the station with the largest signal. The FS700 may be set to a specific station - "M" (master), or one of secondaries. If a chain existed at the chosen GRI when the FS700 was shipped, the actual station names (a subset of V, W,X,Y, and Z) will be displayed; otherwise the secondary may be set to an index of A,B,C, D, or E - the order of transmission of the secondaries. The identification of the secondaries is determined by the timing of the secondaries relative to the master station. For a chain not in the FS700's station list a default set of times will be used- an average of the timings of existing chains. If the unknown chain's timing differs greatly from typical it may not be possible to identify and select a particular secondary. However, the master may always be selected, and AUTO will always select the largest station- regardless of the identification of the secondaries. This allows the FS700 to be set to any possible LORAN station, even if it didn't exist at the time of the FS700's production. Once a station has been chosen, during AUTO station selection the FS700 will display the station identification in parentheses after the word AUTO. For example: AUTO (Y) if Y has been chosen. If the FS700 is set to lock to a specific station and the master station is not found, the selected station will not be identified and the search will fail.

The third field is the station location field. This field displays the location (station name) of the selected station. By scrolling through this list using the up and down arrow keys a station near the receiver may be chosen. All stations that existed at the time of the FS700's production are in this list. If no station exists at the current GRI or station choice

the location message will display that fact. In AUTO station selection the FS700 will display the station location once a station is chosen.

Search Mode: Auto  
Start Station Acquisition (EXC)

### Search Mode

The second screen has two parameters and controls the starting and stopping of the locking process. The first field controls the SEARCH MODE. In AUTO search mode the FS700 will automatically begin a station search any time it is unlocked. In MANUAL mode pressing EXC will start the search. If a signal error occurs and the FS700 unlocks, the FS700 will automatically reacquire a station in AUTO mode, while in MANUAL the lock must be manually restarted. The second field controls starting and stopping of locking and searches. If the FS700 is not currently searching or locked, pushing the EXC button will start a search. If the FS700 is searching or locking, pressing the EXC button will stop the lock. In AUTO search mode, a new search will automatically be started once the EXC button is pressed to stop the search. If manual control is desired, the mode should be set to manual.

Receiver Time Constant: 4096 GRI

### Time Constant

The FS700's tracking time constant is set in the third screen in units of GRI. The time constant is adjusted using the cursor keys, and can be set between 128 and 16384 GRI. The time constant sets the amount of signal averaging and the time between corrections of the FS700's oscillator frequency. The setting is a trade-off between averaging enough to reduce signal noise, and correcting frequently enough to correct oscillator frequency changes with room temperature, etc. Recommended settings are 2048 GRI with the standard oscillator, and 4096 GRI with option 1. If the signal-to-noise ratio of the station being tracked is poor (< -3 dB), the time constants should be increased by a factor of two or four. In general, there is no reason to reduce the time constants below their nominal value.

Tracking Keys Lockout: On  
Enter Password to Lock Keys:XXXXX

### Keyboard Lock

The menu items that control the FS700's station tracking may be locked to prevent unauthorized modification. To lock all items in the TRACKING and CAL menus, enter a password up to 4 digits long. Entering the password again will unlock the menu items. On power-up the keyboard lock is automatically cleared. Other features of the FS700, such as the FREQUENCY OUTPUT and PHASE meter will operate normally while the TRACKING menus are locked.

Receiver Gain: 75dB  
Noise Margin: 33dB

## Status Menu

### Gain, Signal to Noise

The first screen displays the FS700's gain and signal-to-noise ratio. The gain is the gain necessary to bring the selected station to full scale signal level. The maximum value is 120 dB. Noise Margin indicates the current LORAN signal quality. A noise margin of 0.0 db is the poorest quality signal useable by the FS700. The maximum value is +55 dB. The gain number is not displayed until after station selection, while the noise margin is not calculated until after the third zero crossing is located.

LORAN Frequency Offset: 2.0 E-11  
Phase: 0.2°

### Phase

The second screen displays the instantaneous frequency offset of the FS700's oscillator from the LORAN signal. That is, it is the value of the last correction that the FS700 made to its oscillator. The time average of this value is zero. The oscillator has a sensitivity of about  $1 \times 10^{-11}$  minimum step size. Also displayed is the instantaneous phase of the FS700's sampling gate relative to the LORAN pulse (in degrees). The long-term fractional frequency difference over any time interval may be calculated from the following formula:

$$dF = \frac{\text{Final Phase} - \text{Initial Phase}}{360 \times 100\text{kHz} \times \text{Time}}$$

where

Time = time interval of measurement

For example: Suppose at the start of a 24 hour period, the phase is 0.1 degree. While at the end of the time interval, the phase is 0.2 degree. Then the average frequency difference is :

$$dF = \frac{0.2 - 0.1}{360 \times 100\text{kHz} \times 24 \text{ hr} \times 3600\text{s/hr}} = 3.2 \times 10^{-14}$$

This means that over a 24 hour period the FS700's oscillator is every bit as good as the source in the LORAN transmitter. The transmitter's Cesium clock is accurate to about  $1-2 \times 10^{-12}$  over the same time period.

Stations Found (Ident: Amp in dB)  
M57 V38 W45 X70\* Y44

## Stations Found

The third screen displays the identification and amplitude of all stations found during the search phase of station acquisition. The amplitudes are displayed in relative dB, and the station that the FS700 is locked to has a "\*" next to it. The station identifications will be displayed if the FS700 knows them. If the master station is not found, the identifications will be listed as "?". If there were no stations assigned at the time of the FS700's manufacture the stations will be listed as "M", "A", "B", etc., since the station labels are unknown. This display is useful in determining the number and strength of the stations in the receiver's location.

Time Since Lock: 12:34:56  
Length Last Unlock: 0:00:00

## Status Timing

The fourth screen displays the amount of time that the FS700 has been locked to its station. This timer can go up to 32767 hours (3.75 years) before it rolls over back to zero. Also displayed is the duration of the most recent time at which the FS700 was unlocked. If the FS700 has never been unlocked this number will be 0:0:0. However, if the FS700 ever became unlocked and had to reacquire a station, the length of time until it became relocked will be displayed. These two times may be used to determine when the FS700 became unlocked.

Signal Status: A r b n o  
Press EXC to clear status

## Signal Quality

The last screen displays information on the quality of the received signal and any transient conditions that may have occurred. The letters a, r, b, n, and o indicate the status of antenna, rf, blink, noise margin, and oscillator warnings. If the letter is displayed in lower case, the condition has not occurred. If the letter is in UPPER case, the condition has been detected in the past. When a warning condition is detected, the associated status indicator is set. The indicators may be reset by pressing EXC. Relocking the receiver will also reset the indicators. The various warnings are described below in the TRACKING PROBLEMS section.

## Track Point Monitoring

It is useful (or confidence building) to monitor the FS700's tracking point (the third zero crossing). This is easily done using a digital oscilloscope that is capable of averaging many signal traces (such as the HP 54501A). The averaging is necessary to reduce the noise on the signal. While the FS700 is locked, the GRI SYNC output on the FS700's rear panel provides a negative going pulse every GRI 500  $\pm$ 5  $\mu$ s before the third zero crossing. The GATE output provides a negative going pulse that brackets the third zero crossing. To monitor the tracking point, trigger the scope with the GRI SYNC pulse. After the FS700 has locked, display the LORAN OUTPUT and GATE output on the scope using a 10  $\mu$ s/div scale with 500  $\mu$ s of trigger delay. This puts the gate

pulse in the middle of the screen. Set the scope to average about 1000 triggers. After the signal has averaged for a while, the LORAN pulse should be easily visible. By expanding the vertical scale it is easy to see the start of the pulse. It is simple to observe the tracking point by counting zero crossings and remembering that the LORAN pulse starts with a positive half cycle that doesn't count as a zero crossing.

## **Notch Filters**

The FS700 has six adjustable notch filters that may be used to eliminate strong interfering signals. Three of the filters can tune from 40 to 90 kHz while the other three tune from 110 to 220 kHz. The filters are tuned by using the six rear panel screw adjustments. Because these filters severely affect the passband shape of the FS700's rf circuitry, they should only be used in cases of extreme interference, where the interference is easily visible at the LORAN output (large random noise does not count).

## **Tuning the Notch Filters**

There are several ways to set the notch filters.

### Best Method:

- 1) While the FS700 is locked or searching, use a rf spectrum analyzer and look at the signal from the LORAN OUTPUT BNC. Because the FS700's LORAN OUTPUT can only drive a high impedance load, and most spectrum analyzers have a 50 ohm input, use a 1 kohm resistor in series with the LORAN OUTPUT and the probe. Set a slow sweep speed because the LORAN emission is pulsed.
- 2) The spectrum of the LORAN pulse is a broad relatively uniform hump from 80 to 120 kHz. Any severe interfering signals should be visible as a large, discrete, repeatable spike on top of this signal.
- 3) Tune the appropriate notch filter to minimize this spike.

### Method Two:

- 1) This method works if the frequency of the interference is known.
- 2) Stop the FS700's lock and set the SEARCH MODE to MANUAL so that it doesn't restart. Attach a signal generator to the FS700's antenna input using the input terminator shown in the TROUBLESHOOTING section of the manual.
- 3) In CAL MENU 1 (press BSP and TIME together), set the attenuators for 64 dB attenuation.
- 4) Set the signal generator to the interfering frequency and adjust the amplitude so that it can be seen at the LORAN OUTPUT.
- 5) Adjust the appropriate notch filter to minimize the offending signal.
- 6) Reattach the antenna and restart the lock.

### Method Three:

- 1) Start the FS700's search. Look at the LORAN OUTPUT on a normal scope with the horizontal speed set so that an entire GRI fits onto the screen.
- 2a) If the interfering signal is so big that it is the only thing visible on the scope, adjust the notch filters so that the interfering signal is minimized.
- 2b) Otherwise, wait until the FS700 has locked and adjust the notch filters to minimize the "fuzz" or noise between the pulses of the selected station.

### **Search Problems**

In general, it is best to set both station selection and search mode to AUTO. The FS700 will then always pick the strongest signal and automatically restart after errors. Although the FS700's station search is usually uneventful, a variety of problems can occur during the search and identification phase of station acquisition. In all cases, if the FS700 fails to acquire the correct station, the best thing to do is try again. This is because the most common problem is some type of transient interference confuses the FS700. The detectable errors during the search phase are:

- |                           |  |
|---------------------------|--|
| No Stations Found -       | This error means that the FS700 is unable to detect anything that resembles a LORAN station. If this happens, check to see that the GRI is set to the correct value and that the antenna is functional.  |
| Too Many Stations Found - | This error occurs if the FS700 detects too many signals that resemble LORAN pulses. This can occur in areas of very high interference. If the interference is locally generated, moving the antenna can reduce the effect. Also, the FS700's notch filters may be used to eliminate strong out-of-band signals.  |
| No Master Station Found - | This error occurs if no master station (station with nine pulses) is detected. In AUTO station select mode, the FS700 will still pick the largest station and function normally. The station identifications will just be unknown. The absence of the master does not affect tracking performance. If a specific station is selected, the station can not be identified and the search will be terminated. |



- Station Not Found - This error will occur if the specific selected station is not detected. This may mean that the station is off the air or out of range.
- Can't Match Phase Code - This error occurs if no phase coding seems to match that of the selected station. Usually this is because the master station has been misidentified.
- Can't Find Third Zero Cross - This error occurs if the FS700 is unable to detect the LORAN pulse third zero crossing.

## Tracking Problems

A variety of problems can crop up once the FS700 is locked and tracking a LORAN station. Most of these conditions are recoverable without loss of frequency accuracy provided that they do not last too long. If an antenna, rf, or blink condition occurs, the FS700 will freeze its FLL so that no erroneous frequency corrections are made. Then, the FS700 will wait for up to 20 minutes for the condition to go away. If the condition goes away, the FS700 will restart its FLL and continue tracking. If the condition does not go away, the FS700 will terminate its lock and display a timeout error message. If the search mode is set to AUTO, the FS700 will restart the acquisition process. Otherwise it will stop. When one of these conditions occurs, the FS700 will turn on the ERR LED (ANT LED for antenna problems) and display a warning message. The signal status indicator in the STATUS menu will also be set. The LED will remain on and the warning message will be displayed for the duration of the condition and will go off when the condition goes away. These conditions are fairly common but rarely last long enough to produce a timeout.

- Antenna Warning - This warning will occur if the current going to the remote antenna preamp is abnormally high or low. This may mean that the antenna has become disconnected or damaged.
- Station Amplitude Fluctuation - This warning occurs when the FS700 detects that the rf signal level has dropped by more than 10 dB during one correction period. Long term variations are ignored.
- Station Blinking - This warning occurs when the FS700 detects that the station being tracked is blinking its first two pulses.
- Noise Margin < 10dB - This warning occurs if the measured signal to noise margin of the station

being tracked drops to less than 10 dB. A different station should be chosen if possible.

Noise Margin < 1dB - This error occurs if the measured signal to noise ratio of the station being tracked drops to less than 1 dB. In this case, tracking is terminated. The FS700 does not wait for the error to go away.

Oscillator near end of Tuning Range - This warning occurs if the internal oscillator is at 75% of full scale to warn the operator that the oscillator needs to be adjusted. This warning should rarely occur, if at all, and is easily corrected by adjusting the oscillator's coarse frequency adjustment screw (see TROUBLESHOOTING section of manual).

Oscillator Tuning Range Exceeded - This error occurs if the internal oscillator is at the end of its electronic tuning range. In this case the lock is terminated. This error should rarely occur, if at all, and is easily corrected by adjusting the oscillator's coarse frequency adjustment screw (see TROUBLESHOOTING section of manual). This error can also occur if the FS700 accidentally tries to lock to something that is not a LORAN station. In this case, restarting the lock will solve the problem.

Excessive Phase Shift - This error occurs if the FS700 detects a sudden, large (>120 degree) phase shift of the LORAN signal relative to the FS700's internal oscillator. In this case the lock is terminated. This error can occur when a LORAN station makes a rare timing error.

## **Frequency Generation and Calibration**

The FS700 has a built-in frequency source and phasemeter. These may be used to generate precise frequencies and to calibrate external frequency sources. The frequency source may be set to output frequencies between 0.01 Hz and 10 MHz. The phasemeter can measure phase differences for input frequencies between 100 kHz and 10 MHz.

Frequency Out: 2.5 MHz

**Frequency Menu**

The frequency of the FS700's FREQUENCY OUTPUT is set in the FREQ menu. This frequency is set using the cursor keys in a 1, 2.5, 5 sequence (for example, 1 kHz, 2.5 kHz, 5 kHz), between 0.01 Hz and 10 MHz. This output has the same accuracy as the 10 MHz sine wave outputs on the rear panel.

Phase: 109°                      dF = 5.6 E-7  
-360                            +360

**Phase Menu**

The FS700's Phase menu allows the measurement of frequency differences between the FS700's internal clock and the OSC IN BNC. The measurement may be made with a 1 sec duration, or in a continuous mode where the frequency difference is displayed for any elapsed time up to 32767 hours.

The first screen of the Phase menu displays the output of the FS700's analog phasemeter. This phasemeter measures the phase difference between the signal at the OSC IN BNC and the FREQUENCY OUTPUT BNC. These signals may range from 100 kHz to 10 MHz. The FREQUENCY OUTPUT must be set to the same nominal frequency as the input signal. The PHASE OUT BNC produces an analog voltage that is proportional to the phase difference between the OSC IN signal and the reference. The coefficient of proportionality is 0.01 V/degree ( $\pm 3.6$  V full scale). The output is digitized with a 8 bit A/D converter, limiting the resolution to 3° for a 1 sec measurement. The analog output is, of course, continuous. The FS700 can measure any frequency offset up to 100% of the reference frequency, but the analog phase output only functions to about 1 kHz offset.

The PHASE between the two signals is displayed in degrees. The range of this number is 0 to  $\pm 360$  degrees. The phase will be greater than zero if the OSC IN frequency is greater than the reference, and will be less than zero if the OSC IN frequency is less than the reference. This displayed value is simply the digitized version of the analog PHASE OUT signal.

dF displays the fractional frequency offset (df/f) of the input relative to the reference. This calculation is made by doing an 1 s measurement of the input frequency. The largest offset that can be measured is 100% of the reference frequency (dF = 1.0 E 0). The smallest offset that can be measured is limited by the FS700's 3° phase digitization resolution. For example, an offset of 3°/s at 10 MHz corresponds to a frequency offset of  $8 \times 10^{-10}$ .

The bar graph display shows the current phase in the form of a bar graph. This display has a range of  $\pm 360^\circ$ . The bar graph can be used

for the calibration of frequency sources by adjusting the frequency of the source until the bar stops moving. The bar should only be used when the frequency offset is less than 10 Hz because at greater offsets the beating of the offset and the display update rate can make the bar appear to stand still even though the offset is still large. Use the dF readout to reduce the frequency difference to less than 10 Hz, then do final adjustment using the bar graph display.

DPhase = 1.09E02°    dF = 5.6 E-12  
 Meas Time = 3:12:57 (EXC = Start)

The second screen of the PHASE menu displays a frequency difference measurement made over an elapsed time of up to 32767 hours. This is useful for measuring very small offsets where the phase change in 1 second is below the FS700's 3° resolution, or where long duration (24 hour, for example) measurements are desired. Pressing the EXC key will start or restart the measurement. Following the key press, the FS700 will keep track of the total elapsed time and the total signal phase shift (for up to 32767 hours). From this data the frequency offset is continuously calculated and updated once a second. Thus, the frequency difference over any time interval may be obtained simply by waiting the desired elapsed time and reading the display.

dPhase displays the total phase shift since the start of the measurement. This number is displayed in degrees in scientific notation. The FS700 can monitor phase shifts up to ±16 million degrees. Meas Time is the elapsed time of the measurement in hours, minutes, and seconds. dF is the fractional frequency offset and is calculated from the equation:

$$dF = \frac{dPhase}{360 \times \text{Frequency} \times \text{Meas Time}}$$

Time of Day: 12:34:56

**Time Menu**

The TIME menu displays, and allows the user to set the time of day. The time is set by entering the current time on the keypad with the hours, minutes, and seconds separated by decimal points. Pressing the EXC key sets the time. This time display accuracy is only as good as the person pressing the button. However, once set, the clock will neither gain nor lose time.



Data: GRIP99400;STRT
Address: <u>17</u>

## Setup Menu

The SETUP menu allows the user to set the FS700's GPIB address, view received GPIB data, and set the display contrast.

The first screen displays the received GPIB data and the GPIB address. The GPIB address may be set in the range of 0 to 30. The last 256 characters that the FS700 has received may be viewed by scrolling the data display back and forth using the up and down arrow keys. The most recently received character is marked by a solid rectangle character.

The second screen controls the contrast of the FS700's LCD display. The contrast may be adjusted using the up and down arrow keys.

The third screen allows RS232 parameters to be set. The baud rate may be 300, 600, 1200, 2400, 4800, or 9600, with odd, even, or no parity, 7 or 8 data bits, and 1 or 2 stop bits, all selected using the up and down arrow keys.



## PROGRAMMING THE FS700

### Communications

The FS700 LORAN Frequency Standard may be remotely programmed via the GPIB (IEEE-488) interface. Any computer that supports this interface may be used to program the FS700. All features of the instrument may be controlled.

### **GPIB Communication**

The FS700 supports the IEEE-488.1 (1978) interface standard. It also supports the required common commands of the IEEE-488.2 (1987) standard. The FS700's device address must be set before attempting to communicate with the FS700 over the GPIB interface. The address is set in the SETUP menu, and may be set between 0 and 30.

### **Front Panel LED's**

The FS700 has two front panel status LEDs that assist in programming. The ERR LED lights and an error message is displayed whenever an error is detected, such as an illegal command, or a parameter out of range. The REM LED is lit whenever the FS700 is in a remote state (front panel locked out). The FS700 may be returned to the local state (front panel active) by pressing the FIELD button.

### **Data Window**

To help find program errors, the FS700 has an input data window which displays the data the FS700 has received over the GPIB interface. This window is displayed in the SETUP menu. The last 256 characters received by the FS700 may be examined using the up and down arrow keys. The character most recently received is marked by a rectangular block character.

### Command Syntax

Communications with the FS700 use ASCII characters. Commands may be in either UPPER or lower case and may contain any number of embedded space characters. A command to the FS700 consists of a four character command mnemonic, arguments if necessary, and a command terminator (linefeed <lf> or EOI). No command processing occurs until a command terminator is received. Commands may require one or more parameters. Multiple parameters are separated by commas ",". Multiple commands may be sent on one command line by separating them by semicolons ";".

There is no need to wait between commands. The FS700 has a 256 character input buffer and processes commands in the order received. If the buffer fills up, the FS700 will hold off GPIB handshaking until the buffer has been partially emptied by command processing. Similarly, the FS700 has a 256 character output buffer to store output until the host computer is ready to receive it. If the output buffer fills up, the buffer is cleared and an error is reported. The input and output buffers may be cleared with the GPIB Device Clear universal command.

The present value of a particular parameter may be determined by querying the FS700 for its value. A query is formed by appending a question mark "?" to the command mnemonic and omitting the desired parameter from the command. If multiple queries are sent on one

command line (separated by semicolons, of course) the answers will be returned in a single response line separated by semicolons. The FS700 sends a linefeed plus EOI as the response terminator.

Examples of Command Formats:

FREQ 27 <lf> Sets the Frequency Output to 10 MHz (1 parameter).  
FREQ? <lf> Queries the Frequency Output setting (query of one parameter command).  
\*IDN? <lf> Queries the device identification (query, no parameters).  
STRT <lf> Starts station search (no parameters).

## Programming Errors

The FS700 reports two types of errors that may occur during command execution: command errors and execution errors. Command errors are errors in the command syntax. For example, unrecognized commands, illegal queries, lack of terminators, and non-numeric arguments are examples of command errors. Execution errors are errors that occur during the execution of syntactically correct commands. For example, out of range parameters and commands that would cause the FS700 to become unlocked are classified as execution errors.

## Detailed Command List

The four letter mnemonic in each command sequence specifies the command. The rest of the sequence consists of parameters. Multiple parameters are separated by commas. Parameters shown in {} are optional while those not in {} are required. Commands that may be queried have a question mark in parentheses (?) after the mnemonic. Commands that may ONLY be queried have a ? after the mnemonic. Commands that MAY NOT be queried have no ?. Do not send () or {} as part of the command.

All variables may be expressed in integer, floating point, or exponential format (i.e., the number five may be expressed as 5, 5.0, or .5E1).

## Tracking Control Commands

### AUTO (?) {i}

The AUTO i command sets the search mode to either manual (i = 0), or auto (i = 1). The AUTO? query returns the current search mode.

### FLLT (?) {i}

The FLLT i command sets the Frequency locked loop time constant to the value indexed by i. The FLLT? query returns the current setting.

i	<u>Time Constant (number of GRI's)</u>
0	128 GRI
1	256 GRI
2	512 GRI
3	1024 GRI
4	2048 GRI
5	4096 GRI



6 8192 GRI  
7 16384 GRI

**GRIP (?) {x}** The GRIP x command sets the GRI to the value x, where x is in units of micro seconds and may range from 40000 to 99990 micro seconds. The value is rounded to the nearest 10 ms. The GRIP? query returns the current GRI setting in units of micro seconds. NOTE: If this command is sent while the FS700 is locked to a station, the command will be ignored and an execution error generated. The FS700 must first be made to stop tracking using the STOP command.

**STOP** The STOP command causes the FS700 to stop tracking a station. NOTE: If the search mode is set to AUTO, acquisition will automatically restart. To manually control the acquisition process, the search mode should be set to manual.

**STRT** The STRT command causes the FS700 to begin station acquisition. If the FS700 is already tracking a station, this command will cause tracking to be restarted.

**STTN (?) {i}** The STTN i command sets the station to be searched for to i. The correspondence of i values to the LORAN stations is shown in the table below. Because the secondary stations in different chains transmit in different orders, look in the station list to determine which secondary station index (1,2,3,4,5) corresponds to which station (V,W,X,Y,Z). If i = -1 the FS700 is set to auto station selection and will lock to the largest station. The STTN ? query will return the index of the station to which the FS700 is supposed to lock. If the FS700 is set to auto station selection, the STTN? query will return the value -1. The actual station that the FS700 picked may be determined using the LSTA? query. NOTE: If this command is sent while the FS700 is locked to a station, the command will be ignored and an execution error generated. The FS700 must first be made to stop tracking using the STOP command.

<b>i</b>	<b><u>Station</u></b>
-1	Auto
0	Master
1	1st secondary (usually V )
2	2nd secondary (usually W)
3	3rd secondary (usually X)
4	4th secondary (usually Y)
5	5th secondary (usually Z)

### **Tracking Status Command**

**GAIN?** The GAIN? query returns the receiver gain (in dB between 0 and 120) during the time that the station being locked to is transmitting. If a station has not been selected -999 will be returned.

**INFO? i** The INFO? i query returns the amplitude and identification information about the i'th station that was located in the station search. The

information is returned in the format: identification, amplitude. The identification number is the station index value defined in the LSTA? query. The amplitude is a relative value in units of dB and can be used to compare the relative amplitudes of stations detected. The value of *i* can range from 0 to the number of stations found minus 1. The number of stations found can be determined using the NSTA? query. If the FS700 has not completed its station search, the values -1,-1 will be returned.

**LFOS?** The LFOS? query returns the instantaneous fractional frequency offset between the LORAN station carrier and the FS700. The value is returned in exponential format with values typically in the  $10^{-10}$  to  $10^{-11}$  range. If the FS700 is not currently locked, the value -999 is returned.

**LPHA?** The LPHA? query returns the instantaneous phase difference between the LORAN station carrier and the FS700's internal 100 kHz source. The value is returned in degrees between -180 and +180 with 0.1 degree resolution. The value -999 will be returned if the FS700 is not currently locked.

**LSTA?** The LSTA? query returns the index of the station to which the FS700 is currently locked. The correspondence of returned values to the LORAN stations is shown in the table below. Because the secondary stations in different chains transmit in different orders, look in the station list to determine which secondary station index (1,2,3,4,5) corresponds to which station (V,W,X,Y,Z). The FS700 will return the value -1 if the station identification is unknown. For example, when the FS700 can not find the master station, then it doesn't know the station identity. The value -999 will be returned if no station has been selected.

<b><i>i</i></b>	<b><u>Station</u></b>
-1	Unknown station identification
0	Master
1	1st secondary (usually V )
2	2nd secondary (usually W)
3	3rd secondary (usually X)
4	4th secondary (usually Y)
5	5th secondary (usually Z)

**NSTA?** The NSTA? query returns the number of stations found during the station search. If the search has not been completed, the value -999 will be returned.

**STON?** The STON? query returns the noise margin of the station to which the FS700 is locked. The returned value is in dB units. If the FS700 is not currently locked, the value -999 is returned.

**TIME (?) {h,m,s}** The TIME command sets the front panel time to h, m, s where the hours, minutes, and seconds are in 24 hour format. The TIME? query returns the present time in the format h, m, s.

**TLCK?** The TLCK? query returns the time duration the FS700 has been locked. The answer is returned in the format h, m, s and the number of hours can go up to 32767. If the FS700 is unlocked, the value 0, 0, 0 is returned.

**TULK?** The TULK? query returns the most recent duration the FS700 was unlocked. The answer is returned in the format h, m, s where the maximum number of hours is 32767. If the FS700 has never been unlocked, the value 0, 0, 0 is returned.

### Phase Meter Commands

**DLTF? i** The DLTF? query returns the fractional frequency difference between the internal source and the external input. The answer is returned in exponential format (x.y E-z). If no input signal is present or the input frequency is set to less than 100 kHz, the value 9.9 E-99 is returned. The value "> 1.0 E0" is returned if the frequency ratio is greater than 1. The parameter i selects either the result of the 1 sec measurement (i=0), or the result of the arbitrary length measurement (i=1).

**DLTP?** The DLTP? query returns the phase change during the current arbitrary length frequency offset measurement. The number is returned in exponential notation ( $\pm x.yy E \pm z$ ). The value 0 E 0 is returned if no measurement is in progress.

**FREQ(?) {i}** The FREQ i command sets the frequency output to the value indexed by i. The FREQ? query reads back the setting of the frequency output. The frequency values corresponding to different values of i are:

<b>i</b>	<b>Frequency</b>
0	0.01 Hz
1	0.02 Hz
2	0.05 Hz
3	0.1 Hz
4	0.25 Hz
5	0.5 Hz
6	1.0 Hz
7	2.5 Hz
8	5.0 Hz
9	10.0 Hz
10	25.0 Hz
11	50.0 Hz
12	100.0 Hz
13	250.0 Hz
14	500.0 Hz
15	1.0 kHz
16	2.5 kHz
17	5.0 kHz
18	10.0 kHz
19	25.0 kHz
20	50.0 kHz

21	100.0	kHz
22	250.0	kHz
23	500.0	kHz
24	1.0	MHz
25	2.5	MHz
26	5.0	MHz
27	10.0	MHz

**PHSE?**

The PHSE? query returns the phase difference between the external input and the internal frequency source. The answer is returned in degrees with 0.1 degree resolution. If an input signal is not present or the output frequency is set to less than 100 kHz, the value -999 is returned.

**PCLR**

The PCLR command clears, and then restarts, the arbitrary length frequency difference measurement.

**PTME?**

The PTME? query returns the elapsed time of the current arbitrary length frequency offset measurement.

## Status Reporting Commands

(See tables at the end of the programming section for definitions of the status bytes.)

<b>*CLS</b>	The *CLS command clears both status registers (standard event register and LORAN status register). This command does not affect the status enable registers.
<b>*ESE(?) {i}</b>	The *ESE command sets the standard event status byte enable register to the decimal value i. The *ESE? query reads the value of the standard event status byte enable register.
<b>*ESR? {i}</b>	The *ESR command reads the value of the standard event status register. If the parameter i is present, the value of bit i is returned. Reading this register will clear it. Reading bit i will clear just bit i.
<b>*IDN?</b>	The *IDN? query returns the FS700's device identification string. This string is in the format: Stanford Research Systems, FS700, 0, version number. "Version number" is the installed firmware version number.
<b>*PSC(?) {i}</b>	The *PSC command sets the value of the power-on status clear bit. If this bit is set to 1, the three status enable registers will be cleared on power up. If this bit is set to 0, the registers will retain the values they had at power down. This allows the generation of power-on service requests, etc. The *PSC? query returns the current value of the power-on status clear bit.
<b>*RST</b>	The *RST command returns the FS700 to its default configuration. If the FS700 is currently locked to a station, this command will cause the FS700 to become unlocked.
<b>*SRE(?) {i}</b>	The *SRE command sets the serial poll status byte enable register to the decimal value i. The *SRE? query reads the value of the serial poll status byte enable register.
<b>*STB? {i}</b>	The *STB? query reads the value of the serial poll byte. If the parameter i is present, the value of bit i is returned. Reading this register does not affect its value.
<b>SENA(?) {i}</b>	The SENNA command sets the LORAN status byte enable register to the decimal value i. The SENNA? query reads the value of the LORAN status byte enable register.
<b>STAT? {i}</b>	The STAT query reads the value of the LORAN status byte. If the parameter i is present the value of bit i is returned. Reading this register will clear it. Reading bit i will only clear bit i.

## Hardware Test Commands

**\*TST?** The \*TST? query initiates the hardware self-test and returns the test status at the completion of the test. If the FS700 is currently locking to a station, this command will be ignored and an execution error will be generated.

The status values are:

<u>Value</u>	<u>Meaning</u>
0	no error
1	system ROM error
2	system RAM error
3	pattern RAM error
4	DAC/ADC error
5	Amplifier/Attenuator error
6	Integrator error

**\$ASC i** The \$ASC command sets the source of the antenna input. If  $i = 0$ , the input looks at the antenna. If  $i = 1$ , the input looks at the internal calibration signal. If the FS700 is currently locking to a station, this command will be ignored and an execution error will be generated.

**\$DAT?** The \$DAT? query returns the raw in-phase and quadrature data from the integrators during locking. This data has been summed over the FLL time constant divided by 4 GRI's. The data is returned in the format: in-phase low word, in-phase high word, quadrature low word, quadrature high word. Each low/high word pair, taken together, forms a 32 bit 2's complement integer that is the summed integrator data.

**\$GAT i** The \$GAT command sets test patterns of the pattern generator gates. If  $i = 0$ , all 4 gates are set to normal pattern. If  $i = 1$ , the gates are set to the CAL1 configuration. If  $i = 2$ , the gates are set to the CAL2 configuration. If the FS700 is currently locking to a station, this command will be ignored and an execution error will be generated.

**\$INT? i** The \$INT? query reads back the raw analog value of integrator  $i$ . If  $i = 4$ , the value of the peak detector is returned.

**\$LCK i** The \$LCK command sets ( $i=1$ ) and resets ( $i=0$ ) the lock output. If the FS700 is currently locking to a station this command will be ignored and an execution error will be generated.

**\$POS i** The \$POS command sets the position of the test gates to  $i * 200\text{ns}$  from the GRI pulse, where  $i = 75 - 4500$ . If the FS700 is currently locking to a station, this command will be ignored and an execution error will be generated.

**ATTN i** The ATTN command sets the FS700's attenuators to  $i$  dB of attenuation ( $i = 0 - 111$ ). If the FS700 is currently locking to a station, this command will be ignored and an execution error will be generated.

## OSCF(?) i

The OSCF command directly sets the oscillator control DAC to i (-32767 to 32767). If the FS700 is currently locking to a station, this command will be ignored and an execution error will be generated.

## Status Byte Definitions

### Status Reporting

The FS700 reports on its status by means of three status bytes: the serial poll byte, the standard event status byte, and the LORAN status byte.

On power on the FS700 may either clear all of its status enable registers or retain the power down values. The action taken is controlled by the \*PSC command and allows such things as power on service requests, etc.

### Serial Poll Status Byte

<u>bit</u>	<u>Name</u>	<u>Usage</u>
0	Lock	The FS700 is locked.
1	Search	The FS700 is searching for a station.
2	unused	-----
3	LORAN	An unmasked bit in the LORAN status byte has been set.
4	MAV	The output buffer is non-empty.
5	ESB	An unmasked bit in the standard event status byte has been set.
6	SRQ/MSS	SRQ (service request) bit.
7	Warmed Up	Set when oscillator warmup period expires.

The LORAN and ESB bits are set whenever any unmasked bit (bit with the corresponding bit in the byte enable register set) in their respective status register is set. These bits are not cleared until the condition which set the bit is cleared. Thus, these bits provide a constant summary of the enabled status bits. A service request will be generated whenever an unmasked bit in the serial poll register is set. Note that service requests are only generated when the bit is first set and thus any condition will only produce one service request. Accordingly, if a service request is desired every time an event occurs the status bit must be clear between events (either by reading it or by using the \*CLS command).

### Standard Event Status Byte

<u>bit</u>	<u>Name</u>	<u>Usage</u>
0	unused	-----

1	unused	-----
2	Query Error	Set on output buffer overflow (answer not being read by host computer).
3	Memory Error	Set on power-up when the battery backed up memory is corrupt.
4	Execution Error	Set by an out of range parameter, or non-completion of a command due to some reason like being locked.
5	Command Error	Set by a command syntax error, or unrecognized command.
6	URQ	Set by any key press.
7	PON	Set on power on.

This status byte is defined by IEEE-488.2 (1987) and is used to report errors in commands. The bits in this register stay set until the register is read or the \*CLS command is received.

#### LORAN Status Byte

<u>bit</u>	<u>Name</u>	<u>Usage</u>
0	Search Error	Set if an error occurs during station search, such as no stations found, desired station not found, etc.
1	Time Out	Set if the duration of a signal error (low rf, blink, etc.) exceeds 20 minutes.
2	Low Sn	Set if the signal-to-noise ratio of the station being tracked is worse than - 20 dB.
3	Blink	Set if blink is detected on the station being tracked.
4	Low rf	Set if the signal level of the station being tracked drops by more than 10 dB.
5	Antenna Error	Set if an antenna fault is detected.
6	Osc Error	Set if the oscillator is at the end of its tuning range.
7	Osc Adj	Set each time the oscillator frequency is adjusted.

These bits stay set until cleared by reading or by the \*CLS command.





# PROGRAMMING EXAMPLES

## Example 1

### IBM PC, Microsoft C Ver. 5.1 Using the National Instruments GPIB Interface.

To successfully interface the FS700 to a PC via the GPIB interface, the instrument, interface card, and interface drivers must all be configured properly. To configure the FS700, the GPIB address must be set in the SETUP menu. The default GPIB address is 17; use this address unless a conflict occurs with other instruments in your system. The FS700 will be set to GPIB address 17 whenever a reset is performed (power on with the BSP key down).

Follow all the instructions for installing the GPIB card. The National Instruments card cannot be simply unpacked and put into the computer. To configure the card set jumpers and switches on the card to set the I/O address and interrupt levels. Run the program "IBCONF" to configure the resident GPIB driver for the GPIB card. Please refer to the National Instruments manual for information. In the example below, the FS700 is installed as a device named "LORAN".

Once all the hardware and GPIB drivers are configured, use "IBIC". This terminal emulation program allows you to send commands to the FS700 directly from the computer's keyboard. If you cannot talk to the FS700 via "IBIC", then your programs will not run.

Use the simple commands provided by National Instruments. Use "IBWRT" and "IBRD" to write and read from the FS700. After you are familiar with these simple commands, explore more complex programming commands.

The example program uses the GRIP command to set the GRI and the STRT command to start a search. The GRIP? query is used to read back the GRI.

```
/* Example program using Microsoft C V5.1 and the National Instruments GPIB card */  
/* This program assumes that the FS700 is installed as device "loran" using IBCONF */
```

```
#include<stdio.h>  
#include<dos.h>  
#include<conio.h>  
#include<stdlib.h>
```

```
#include"decl.h"           /* National Instruments Header File */
```

```
void main(void);
```

```
int    ibfind(char *);           /* Function Prototypes for GPIB Calls */  
void   ibwrt(int,char *,int);  
void   ibrd(int,char *,int);
```

```
void main(void)  
{  
int i;  
int FS700;  
char tstr[20];
```

```

if ( FS700=ibfind("loran"))<=0 ) {      /* Find Device */
    printf("Cannot Find Device LORAN\n");
    exit(0);
}

ibwrt (FS700,"*STB?",5);                /* reads status byte */
ibrd (FS700,tstr,20);                   /* read answer */
tstr[ibcnt] = 0;                         /* terminate string */
sscanf (tstr,"%d",&i);                  /* convert answer to integer */

if ( i & 3)                              /* searching or locked ? */
{
    printf ("Already searching\n");
    exit (0);
}

ibwrt(FS700,"GRIP 99400",10);           /* set GRI to west coast USA */
ibwrt(FS700,"AUTO 0",6);                /* Set set search mode to MANUAL */
ibwrt(FS700,"STRT",4);                  /* start search */

ibwrt(FS700,"GRIP?",5);                 /* Query GRI Level */
ibrd(FS700,tstr,20);
tstr[ibcnt]=0;                          /* Terminate Received String */

printf("GRI = %s\n",tstr);

printf("Program Executed Normally\n");
}

```

## Example 2

### IBM PC, IBM BASIC Using the National Instruments GPIB Interface.

Refer to the previous example for a discussion about the National Instruments GPIB interface.

This BASIC program does exactly the same thing as the C program in the previous example. Be sure to use the file DECL.BAS provided by National Instruments to start the program. DECL.BAS contains the initialization procedures for the GPIB driver.

```
10 ' EXAMPLE PROGRAM USING MICROSOFT BASIC AND THE NATIONAL INSTRUMENTS GPIB CARD
30 ' THIS PROGRAM ASSUMES THAT THE FS700 IS INSTALLED AS DEVICE LORAN USING IBCONF
40 '
50 ' USE THE FILE DECL.BAS PROVIDED BY NATIONAL INSTRUMENTS TO INITIALIZE THE GPIB
DRIVER
60 '
100 CLEAR ,60000! : IBINIT1=60000! : IBINIT2=IBINIT1+3 : BLOAD "bib.m",IBINIT1
110 CALL IBINIT1(IBFIND, IBTRG, IBCLR, IBPCT, IBSIC, IBLOC, IBPPC, IBBNA, IBONL, IBRSC, IBSRE,
IBRSV, IBPAD, IBSAD, IBIST, IBDMA, IBEOS, IBTMO, IBEOT, IBRDF, IBWRTF, IBTRAP)
120 CALL IBINIT2(IBGTS, IBCAC, IBWAIT, IBPOKE, IBWRT, IBWRTA, IBCMD, IBCMDA, IBRD, IBRDA,
IBSTOP, IBRPP, IBRSP, IBDIAG, IBXTRC, IBRDI, IBWRTI, IBRDIA, IBWRTIA, IBSTA%, IBERR%, IBCNT%)
130 '
140 ' DONE WITH DECL.BAS
150 '
160 ' OUR PROGRAM STARTS HERE
170 BDNAMES$="LORAN"
180 CALL IBFIND(BDNAMES$, FS700%) ' FIND FS700
190 IF FS700% < 0 GOTO 1000
200 '
210 WRT$="GRIP 99400"      ' SET WEST COAST USA GRI
220 CALL IBWRT(FS700%, WRT$)
230 '
240 WRT$="AUTO 0"  'SET TO MANUAL SEARCH
250 CALL IBWRT(FS700%, WRT$)
260 '
270 WRT$="STRT"    ' START SEARCH
280 CALL IBWRT(FS700%, WRT$)
290 '
300 WRT$="GRIP?"  ' QUERY GRI
320 CALL IBWRT(FS700%, WRT$)
330 '
350 S$=SPACE$(20)  'PRINT GRI RESPONSE
360 CALL IBRD(FS700%, S$)
370 PRINT "GRI =",S$
380 '
390 STOP
1000 PRINT "CANNOT FIND DEVICE LORAN"
1010 STOP
```



## TROUBLESHOOTING

Initially, make sure the power entry module on the rear panel is set for the AC line voltage for your area, the correct fuse is installed, and the line cord is inserted all the way into the power entry module. The selected line voltage may be seen through the clear window, just below the fuse.

When the unit is plugged in and turned "ON", the units model number, and firmware version number will be briefly displayed. Then the self test will execute.

If the unit displays no sensible message, the internal memory may be corrupted and a "cold boot" may fix the problem. To do a "cold boot", turn the unit off. Then, while holding the BSP key down, turn the unit "ON". This procedure initialize all data in the FS700's RAM.

### Self Test Errors

The self-tests procedure may fail with an error message. The messages that may be displayed are listed below:

System ROM Test FAIL	This message will occur if the FS700 determines that the contents of its ROM are no longer the same as originally programmed. The ROM must be replaced.
System Memory Test FAIL	This message occurs if the RAM memory cannot reliably be written and read. The RAM must be replaced.
Pattern Memory Test FAIL	This message occurs if the pattern generator RAM may not be reliably written and read. This indicates a problem in the RAM or the address generation circuitry.
DAC/ADC Test FAIL	This message indicates a problem in the 16 bit DAC, the ADC, or the analog multiplexer.
Amplifier Gain FAIL	This message indicates that the gain of the RF stages is either too high or low. Usually this means that an amplifier, analog switch, or the peak detector is dead.
Attenuator X FAIL	This message indicates that the attenuation for attenuator X (1,2,3,4) is out of range. This usually means that an analog switch is dead.

Integrator X High Gain FAIL This message indicates a problem with the displayed integrator (1,2,3,4) in the high gain setting (short time constant).

Integrator (3,4) Low Gain FAIL This message indicates a problem with the displayed integrator in the low gain setting.

Memory Lost - Defaults Recalled This message indicates that the battery backed up settings have been forgotten. Occasionally, glitches can cause this problem. However, if this error recurs the Lithium battery may be dead.

### **GPIB Interface Problems**

For proper operation the GPIB address of the FS700 must be set to match that expected by the controlling computer. The default GPIB address is 17, and it is a good idea to use this number in writing programs. Any address in the range of 0 to 30 may be set in the SETUP menu.

The FS700 will ignore its front panel when in the "REMOTE" state (Remote Enable line asserted on GPIB interface). This state is indicated by the front panel REM LED. To return to LOCAL operation (i.e. to enable the front panel) press the FIELD key. Controlling programs may inhibit the ability to return to LOCAL operation by asserting Local-Lockout state (LLO).

The FS700 expects commands sent to it to be terminated by a linefeed character or the "End or Identify" (EOI) message. Answers returned by the FS700 are always terminated by a linefeed sent in conjunction with EOI. Make sure that the controlling computer has been configured to generate and accept these sequences.

## HARDWARE TROUBLESHOOTING PROCEDURES

The following procedures describe a few simple tests as an aid in debugging hardware problems. First, make sure that the FS700 is not locking or searching by entering the TRACKING menu, setting the SEARCH MODE to MANUAL, and stopping the lock. The FS700 has two calibration menus (CAL MENU 1 and 2) that are accessed by pressing the BSP key simultaneously with either the TIME or FREQ key. It is helpful to read the circuit description for the relevant section before attempting troubleshooting.

### 16 Bit DAC Test

The FS700's 16 bit DAC may be directly set from the front panel for test purposes. Enter CAL MENU 2 by pressing the BSP and FREQ keys together. The field displayed allows the 16 bit DAC to be set to any value between -32767 and +32767. This should produce an output at the DAC between -3 V and +3 V. Each bit change produces an 92 mV step. The DAC should be accurate to  $\pm 30$  mV  $\pm 2$  % of setting.

### RF Circuitry Tests

To test the RF circuitry, a 100 kHz signal must be applied to the antenna input of the FS700. Because the FS700 is designed to provide power to the active antenna, the 100 kHz signal must be applied through a special ANTENNA TERMINATOR circuit shown in Figure 1. This terminator allows application of a signal while maintaining correct DC bias conditions.

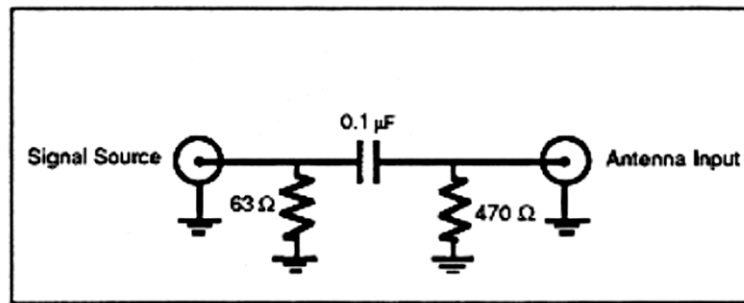

Figure 1.

Antenna Termination Adapter

The FS700's rf attenuators may be set directly in CAL MENU 1. The allowable range is 0 to 111 dB. With an input signal of 10 mV peak-to-peak and the attenuators set to 64 dB, the FS700 should produce an output of about 0.5 V rms at the LORAN OUTPUT BNC.

By adjusting the attenuators, the signal level, and measuring the output level, the attenuator values may be checked. Be careful not to saturate any of the gain stages.



## **Integrator Tests**

The integrators may be tested by applying a 100 kHz test signal to the antenna input through the ANTENNA TERMINATOR as described above. Set the attenuators (in CAL MENU 1) to 64 dB and adjust the signal level to get about 6 V pk-pk at the LORAN OUTPUT.

The integrator gate type and position may be controlled in CAL MENU 1. The first screen allows setting the gate types to either NORM, CAL1, or CAL2. CAL1 and CAL2 are the test settings. The CAL 1 setting tests the high gain settings of the integrators. CAL 2 tests the high gain setting of integrators 1 and 2 and the low gain setting of integrators 3 and 4. The second screen allows the gate position to be changed and displays the integrator output data. The gate position may be set to any value between 75 and 4500. Each step corresponds to a 200 ns difference in position (50 steps = 10  $\mu$ s = 1 cycle of input). The integrator output data has an ADC range of -128 to +127 corresponding to -5V to +5V.

In either gate position, stepping the gate position through a single 100 kHz cycle (10  $\mu$ s = 50 steps) should result in the integrator outputs going through a complete cycle of output voltage (full scale =  $\pm 2$  to  $\pm 4$  V or ADC values of  $\pm 50$  to  $\pm 100$ ). By stepping the gate, one can verify that the integrator can swing both positive and negative, can be reset (just before the gates), and can change time constants. Measure the integrator outputs at the input to the analog multiplexer U602.

## **Peak Detector Test**

To test the signal peak detector (used for AGC purposes), apply a 100 kHz signal to the antenna input through the ANTENNA TERMINATOR. In CAL MENU 1 set the attenuators for 64 dB and the gates for either CAL 1 or CAL 2. As the input signal level is varied the peak detector output (U116 pin 2) should be a DC voltage whose magnitude is about the peak positive signal level of the LORAN OUTPUT.

# PERFORMANCE TESTS

## Introduction

The following tests check the performance of the FS700 and verify that the hardware functions properly. The results of each test may be recorded on the test sheet at the end of this section. Calibration of the FS700 should only be attempted if the relevant performance test fails.

## Necessary Equipment

The following equipment is necessary to complete the tests. The suggested equipment or its equivalent may be used.

- 1) 100 MHz Oscilloscope
- 2) Synthesized sweepable function generator, 50 ohm output, 1 mV minimum amplitude, such as Hewlett-Packard 3325B.
- 3) Precision Frequency Counter with at least  $1 \times 10^{-9}$  resolution, such as SRS SR620.
- 4) Precision voltmeter with AC bandwidth of at least 100 kHz, such as Fluke 8840A.
- 5) 10 MHz frequency source known to be more accurate than  $1 \times 10^{-8}$ .
- 6) Antenna Input Termination Adapter. Schematic is shown in TROUBLESHOOTING section Figure 1.

## Tests

### **Start Tests**

For the duration of these tests, make sure the FS700 is not trying to lock to a station. Go to the TRACKING menu and set the SEARCH MODE to MANUAL. If either the LOCK or SEARCH LEDs are on, stop the search/lock. Unless otherwise specified, it is assumed that jumpers JP104 - 107 are in their normal operational position, i.e. JP104 in, JP105-107 out.

### **Front Panel Test**

This test verifies the functionality of the front panel display, LEDs, and keys.

- 1) Turn on the FS700 while holding down the "TIME" key. The turn-on message should appear and stay on the display. The lock LED should turn on.

- 2) Use the up arrow key to light each LED in turn. Only a single LED should be on at a time. The down arrow key will step backward through the sequence.
- 3) After lighting the REM LED, pressing the up arrow key again will enter keyboard test mode. Now pressing a key will display the name of the key on the display.
- 4) Turn the FS700 off and then on again to restore normal operation. Record the results of this test.

### **RF Bandwidth Test**

These tests check the shape of the FS700's 100 kHz bandpass filter, and the overall gain of the receiver.

Note:  $\text{dB} = 20 \log_{10} (v_2 / v_1)$

- 1) Connect the function generator to the antenna input through the antenna terminator. Set it to sine wave, 10 mV amplitude, 100 kHz.
- 2) In CAL MENU 1 (press BSP and TIME key simultaneously), set the attenuators to 64 dB. Look at the FS700 LORAN OUTPUT on the scope, and measure the amplitude with the AC voltmeter. The amplitude should be  $0.4 \text{ vrms} \pm 0.3$ . This is the "nominal" amplitude. Record this number on the test sheet.
- 3) Set the frequency to 90 kHz and record the voltage. Calculate the voltage ratio in dB. This reading should be nominal  $\pm 2$  dB. Record this number.
- 4) Repeat step 3 with a frequency of 110 kHz.
- 5) Set the frequency to 80 kHz and record the voltage. Calculate the voltage ratio in dB. This reading should be between nominal -1 dB and nominal -6 dB. Record this number.
- 6) Repeat step 5 with a frequency of 120 kHz.
- 7) Set the frequency to 50 kHz and record the voltage. Calculate the voltage ratio in dB. This reading should be at least -25 dB below nominal. Record this number.
- 8) Repeat step 7 with a frequency of 150 kHz.
- 9) If the readings are out of range, the bandpass filter may need to be calibrated.

### **Internal Self-Tests**

The self-tests test the functionality of the system ROM and RAM, the pattern RAM, the DAC/ADC combination, the rf attenuators, and the gated integrators.

- 1) Turn on the FS700. The model number and firmware version number should be displayed for about three seconds. Then the self-tests will execute. If any of the tests fail, refer to the TROUBLESHOOTING section of the manual for a description of the error messages. Record the test results.

### Notch Filter Check

These tests check that the six notch filters are working correctly.

- 1) Remove the top cover of the FS700. Remove JP104 and insert JP105-107. This configuration will bypass the FS700's bandpass filter. Set all notch filters to their extremes, i.e. 40 and 220 kHz. Set the FS700's attenuator to 64 dB (in CAL MENU 1, press BSP and TIME keys together). Look at LORAN OUTPUT on the scope.
- 2) Set the function generator to sweep from 1 kHz to 300 kHz, sine wave, 200 mV amplitude, and attach signal to right pin of the jumper JP104 (viewed from front).
- 3) Tune the frequency of a single filter. Check to be sure that the notch moves over the appropriate range. Check that the depth of the notch is at least 20 dB. Record the notch depth. Return the filter to its extreme.
- 4) Repeat step 3 for the other filters.
- 5) If any of the notches are less than 20 dB deep, they may need to be calibrated.
- 6) Reset all of the filters to their extremes. Put JP104 back in and take out JP105-107.

### 10 MHz Oscillator Check

This test checks the wave shape and amplitude of the 10 MHz outputs and verifies that the FS700 is not near the end of its electronic tuning range.

**Note:** The FS700 should be turned on and warmed up for at least 1 hour before performing this test.

- 1) Use the 10 MHz source as the reference clock to the counter.
- 2) In CAL MENU 2 (press BSP and FREQ simultaneously) set the oscillator control DAC for 0.
- 3) Measure the frequency of one of the 10 MHz sine wave outputs. It should be within  $\pm 5 \times 10^{-8}$  of 10 MHz. Record the number. If the difference is greater than the specification, the coarse adjustment screw of the oscillator may need to be adjusted.

- 4) Look at the four 10 MHz outputs on the scope with 50 W termination. The outputs should be sine waves with an amplitude between 0.75 and 2 V peak-to-peak.

### **Phasemeter Check**

This test checks the functionality of the FS700's phasemeter and internal frequency synthesizer.

- 1) Use the frequency counter to measure the frequency of the FS700's frequency output. Measure the output with the frequency set to 10 MHz, 5 MHz, 100 kHz, 1 kHz, and 10 Hz. In all cases the frequencies should be within  $1 \times 10^{-5}$  of their setting. Record the results.

- 2) Set the synthesizer to 100.1 kHz, 0.5 V pk-pk, and attach to the FS700's OSC IN BNC.

- 3) Set the FS700's FREQUENCY OUTPUT to 100 kHz. Look at the PHASE OUTPUT on the scope. The output should be a positive sawtooth wave at 100 Hz going from 0 to +3.6 V ( $\pm 300$  mV). Read the FS700's front panel frequency offset reading. The offset should read  $1 \pm 0.1 \times 10^{-3}$ . Record the results.

- 4) Set the synthesizer to 99.9 kHz. The PHASE OUTPUT should be a 100 Hz negative sawtooth going from 0 to -3.6 V ( $\pm 300$  mV). Read the FS700's front panel frequency offset reading. The offset should read  $-1 \pm 0.1 \times 10^{-3}$ . Record the results.

**\*\*\*\*THIS COMPLETES THE PERFORMANCE TESTS\*\*\*\***

### FS700 PERFORMANCE TEST RECORD

Serial Number: \_\_\_\_\_ Oscillator: \_\_\_\_\_

Tested By: \_\_\_\_\_ Date: \_\_\_\_\_ Temperature: \_\_\_\_\_

Comments:

**Performance Tests**

Display Test     Fail     Pass

	Minimum	Actual	Maximum
--	---------	--------	---------

**RF Bandwidth Tests**

Nominal Signal Level	0.1 V rms	_____	0.7 V rms
90 kHz Amplitude	Nominal - 2 dB	_____	Nominal +2 dB
110 kHz Amplitude	Nominal - 2 dB	_____	Nominal +2 dB
80 kHz Amplitude	Nominal - 6 dB	_____	Nominal - 1 dB
110 kHz Amplitude	Nominal - 6 dB	_____	Nominal - 1 dB
50 kHz Amplitude	Nominal - 25 dB	_____	Nominal -25 dB
150 kHz Amplitude	Nominal - 25 dB	_____	Nominal -25 dB

Self Tests     Fail     Pass

**Notch Filter Tests**

Filter 1 Notch		_____	Nominal -20 dB
Filter 2 Notch		_____	Nominal -20 dB
Filter 3 Notch		_____	Nominal -20 dB
Filter 4 Notch		_____	Nominal -20 dB
Filter 5 Notch		_____	Nominal -20 dB
Filter 6 Notch		_____	Nominal -20 dB

10 MHz Oscillator Frequency	9999999.5 Hz	_____	10000000.5 Hz
Output 1 Amplitude	0.5 V pk-pk	_____	2 V pk-pk
Output 2 Amplitude	0.5 V pk-pk	_____	2 V pk-pk
Output 3 Amplitude	0.5 V pk-pk	_____	2 V pk-pk
Output 4 Amplitude	0.5 V pk-pk	_____	2 V pk-pk

**Frequency Output**

10 MHz Frequency	9999900.0 Hz	_____	10000100.0 Hz
5 MHz Frequency	4999950.0 Hz	_____	5000050.0 Hz
100 kHz Frequency	99999.0 Hz	_____	100001.0 Hz
1 kHz Frequency	999.990 Hz	_____	1000.01 Hz
10 Hz Frequency	9.99990 Hz	_____	10.0001 Hz

**Phasemeter**

100.1 kHz Amplitude     Fail     Pass

100.1 kHz Offset	9.9 E-4	_____	1.1 E-3
99.9 kHz Amplitude	_____	Fail	_____ Pass
99.9 kHz Offset	-1.1 E-3	_____	-9.9 E-4

# CALIBRATION

The procedures listed in the following section allow the adjustment of the FS700's bandpass filters, notch filters, and coarse adjustment of the internal crystal oscillator. These are the only adjustments necessary to completely calibrate the FS700. These calibrations should be rarely, if ever, needed.

**Note:** All or any part of this calibration procedure may be performed.

## Necessary Equipment

The following equipment is necessary to complete the FS700 calibration. The suggested equipment or its equivalent may be used.

- 1) 100 MHz Oscilloscope
- 2) Synthesized sweepable function generator, 50 ohm output, 1 mV minimum amplitude, such as Hewlett-Packard 3325B.
- 3) Precision Frequency Counter with at least  $1 \times 10^{-9}$  resolution, such as SRS SR620.
- 4) Antenna Input Termination Adapter. Schematic is shown in TROUBLESHOOTING section Figure 1.

## Coarse Oscillator Adjustment

There are two ways to adjust the oscillator. The first method requires that the FS700 be locked to a LORAN station. The second method requires a 10 MHz frequency source known to be accurate to better than  $5 \times 10^{-9}$ .

**Note:** The FS700's oscillator should be on and warmed up for at least 1 hour prior to performing this procedure. Do not adjust the oscillator if it is already within  $5 \times 10^{-8}$  of 10 MHz (when locked the DAC value is less than 10000).

### Procedure 1:

- 1) Lock the FS700 to a LORAN-C station.

**Note:** The next four steps must be done quickly, be familiar with the procedure before starting.

- 2) Measure the 10 MHz output frequency on the counter. Record the number.



- 3) Stop the FS700's lock (in the TRACKING menu set SEARCH MODE to MANUAL and STOP lock).
- 4) In CAL MENU 2 (press BSP and FREQ keys simultaneously) set the oscillator DAC to 0.
- 5) Measure the 10 MHz output frequency and adjust the oscillator coarse adjustment screw until the counter reads the same number as before.

Procedure 2:

- 1) Make sure the FS700 is not locked to a station.
- 2) Use the 10 MHz frequency source as the clock for the frequency counter.
- 3) In CAL MENU 2 (press BSP and FREQ keys simultaneously) set the oscillator DAC to 0.
- 4) Measure the 10 MHz output from the FS700 and adjust the oscillator coarse adjustment screw until the counter reads within  $1 \times 10^{-8}$  of 10 MHz.

**Bandpass Filter Alignment**

This procedure aligns the FS700's 100 kHz bandpass filter. This alignment should be done only if the bandpass filter check in the PERFORMANCE TESTS section of the manual is failed.

- 1) Attach the function generator to the FS700's antenna input through the antenna terminator. Set the function generator for 10 mV pk-pk sine wave sweeping from 1 kHz to 200 kHz. Attach the generator sweep x drive output to the scope x input.

Figure 1.  
Bandpass Filter  
Response with L115 Out

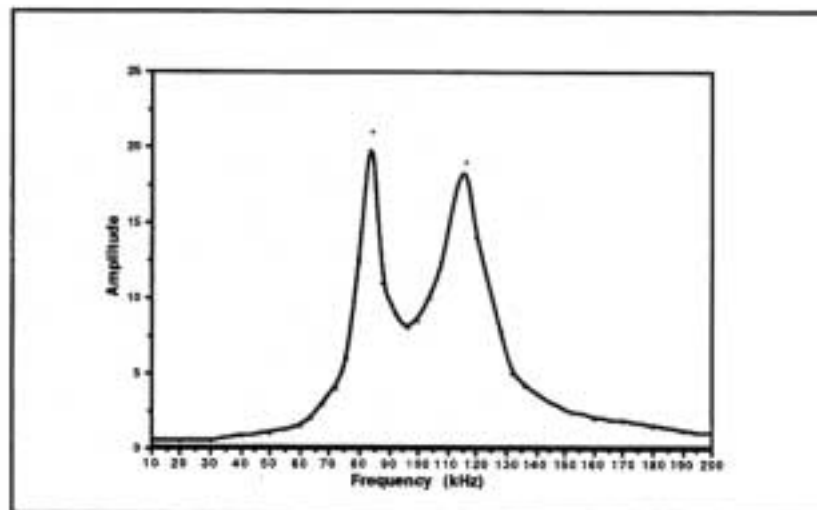

- 2) In CAL MENU 1 (press BSP and TIME keys simultaneously), set the FS700's attenuators for 64 dB. Look at the LORAN OUTPUT on the scope in x-y mode ( to see the sweep). Make sure that the notch filters are set to their extremes (40 and 220 kHz). Install jumpers JP105, JP106, and JP107 (these are out in normal operation).
- 2) Back L115 most of the way out. There should be two peaks in the pass band. Adjust L113 and L114 so that these peaks are of equal height and spaced symmetrically about 100 kHz at about 82 and 118 kHz. (See Figure 1.)
- 4) Adjust L115 so there is only a slight (~5%) dip in the passband. L114 may need to be tweaked to remove any passband slope. (See Figure 2.)

Figure 2.  
Overall Bandpass Filter Response

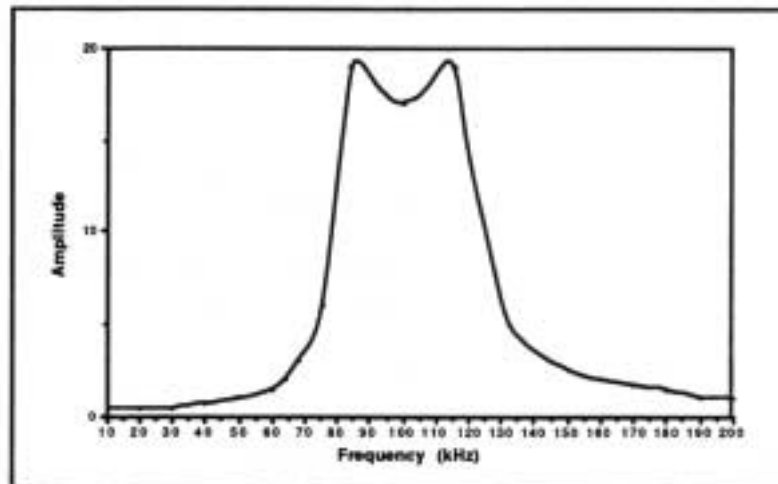

- 5) Remove JP105, JP106, and JP107. Stop the function generator sweep.
- 6) Set the frequency to 78.8 kHz and adjust L116 for maximum response.
- 7) Set the frequency to 120.5 kHz and adjust L117 for maximum response.
- 8) Set the frequency to 100 kHz and adjust L118 for maximum response.
- 9) Check the passband response using the test in the PERFORMANCE TESTS section of the manual.

## Notch Filter Alignment

This procedure aligns the six notch filters. The procedure describes alignment of a single filter, the procedure is identical for all six filters. This alignment should be done only if the notch filter check in the PERFORMANCE TESTS section of the manual has failed.

- 1) Set the function generator for 200 mV pk-pk sine wave.
- 2) In CAL MENU 1 (press BSP and TIME keys simultaneously) set the FS700's attenuators for 64 dB. Look at the LORAN OUTPUT on the scope. Set the notch filters to the middle of their range. Remove jumper JP104 and attach the function generator to the right pin of the jumper (viewed from the front). Install jumpers JP105, JP106, and JP107 (these are out in normal operation). This configuration bypasses the FS700's 100 kHz bandpass filter.
- 3) Set one filter to its lowest frequency (40 or 110 kHz). Set the function generator to the same frequency.
- 4) Adjust the two filter inductors (L107 and L108, for example) to minimize the signal output.
- 5) Set the function generator to the maximum filter frequency (90 or 220 kHz). Tune the filter to minimize its output.
- 6) Adjust the trim capacitors (C119C-F, for example) to minimize the signal output.
- 7) Set the filter to its midrange.
- 8) Repeat this procedure for the rest of the filters.
- 9) Set the filters to their extremes (40 and 220 kHz).
- 10) Install jumper JP104 and remove JP105, JP106, and JP107.



# CIRCUIT DESCRIPTION

## Front End/Notch Filters (p. 1/14)

The power for the active antenna (see page 14/14) is provided by Q101 and the bias network consisting of R102 and R103. Relay K101 selects the antenna as the front end input during normal operation, and a 100 kHz calibration signal during unit self testing. To detect problems with the antenna electronics, a VANT signal representing the current drawn by the antenna system is sensed through divider R125 and R126 and fed to the A/D converter. (see page 7/14)

The 100 kHz LORAN-C signal is filtered by the third-order Bessel filter consisting of L113, L114, and L115, and C102, C114, and C115. The front end filtering stages are designed to minimize phase distortion, and NPO capacitors are used to minimize changes in filter parameters over temperature. The filter is then followed by the first of four attenuators, each of which consists of a resistive divider which is tapped based on the setting of CMOS switches (here, U101A-U101D). The attenuator stage is buffered by op amp U102 which provides about 22.5 dB of signal gain.

Following the first attenuator are six individually tuned stages of notch filters. Three of the filter stages can be tuned to notch out interfering signals in the 110-220 kHz range, and the other three stages can be tuned in the 40-90 kHz range. All of the notch filters are of the same design, and the references in the following description apply to the first notch filter. The filters are designed to provide less than 1 dB of distortion in the 90-110 kHz band. Each filter is essentially made of two RLC networks, with interstage unity gain buffers. R108, L101, and 1/2 of C116 make up one half of the first notch filter, and R109, L102, and 2/2 of C116 make up the second half. C116 is a ganged tuning capacitor with integral 7 pf trimmer capacitors. Additional trimming is provided by the two 47 pf capacitors C122 and C123. U103 provides the interstage buffering. The following stages are identical, with appropriate changes in part values for the 40-90 kHz filters.

## LORAN Front End (p. 2/14)

Following the notch filters are three stages of filters, attenuators, and 22.5 dB gain stages. Each stage differs only in the attenuator step size and in the center frequency of the filter. The three filters taken together form a third-order Bessel filter. In the following description, references are to parts in the first stage. The filter is made up of L116, C126, and the total resistance of the attenuator, about 2 k ohms, divided between R133, R134, R141, and R142. CMOS switch U109 selects taps of -0, -16, -32, or -48 dB under micro-processor control for AGC. This stage is buffered by U110 which provides about 22.5 dB of signal gain. The following stages are similar. The next stage provides up to 16 dB of

attenuation in 4 dB steps, and the last stage provides up to 3 dB of attenuation in 1 dB steps.

The LORAN signal present after the filter stages is provided directly to integrator stages to be discussed later, and is also demodulated for AGC use. The AGC peak detector consists of D101, R146, C125, and switch U409C, which is processor controlled to reset the peak detector output. Op-amp U116A buffers the output of the detector. The amp is configured to have unity gain. R147 and R148 form a divider which limits the maximum signal excursion to the 5 V range which is tolerated by the analog to digital converter used for gain control.

Transistor Q102 provides an indication of receiver lock to rear-panel BNC connector J103. This output is pulled to +5 V through 10 k ohms, and is normally high when the receiver is locked.

### **Microprocessor System (p. 3/14)**

The FS700 is controlled by a 5 MHz CMOS version of the Z80. The 5 MHz clock is derived from the 10 MHz system reference. The unit's firmware resides in a 27256 UVEPROM (U207). The processor also uses 32 kilobytes of RAM. The RAM is also battery backed-up so that instrument settings may be recalled after the unit is turned off. When the +5 V supply is lost, power for the RAM is provided by a lithium battery through blocking diode D202 and R201. Also, the chip select line for the RAM is disabled on power down by the RESET line through Q201. This prevents corruption of the RAM contents when power is lost. U204 and U212 are demultiplexers which provide the 16 port strobes used by the system. The buffered data bus is provided by U205, an 8-bit bus transceiver that enables the bus only during I/O requests by the Z80.

GPIO interfacing is provided by U209, a TMS9914A controller IC, and by U210 and U211, which buffer data and control lines to the GPIO connector. The controller IC generates the required control signals for GPIO communication, as well as providing an interrupt to the processor when data is received over the GPIO interface.

The front panel LCD interfaces through J201 to the buffered data bus, along with two address lines, a chip select line, +5 V power and ground, and a display contrast line. For high contrast and good readability, a supertwist LCD design is used.

An 8254 triple programmable counter is used to generate a GRI interval as well as two frequency sources. The two frequency sources are cascaded so that the 5 MHz clocking frequency can be divided to lower frequencies. Clocking for the GRI interval timer is provided by a 100 kHz clock source derived from the master 10 MHz source.

### **I/O Ports and Interrupt Drivers (p. 4/14)**

Five 74HC374 Octal Flip-Flops provide latched output bits, and two 74HC244 Octal Buffers provide input bits to the buffered data bus. The front panel switch connector J301 provides eight outputs for the LED's on the front panel, along with +5 V power and ground. Eight input lines are also provided to read the status of the front panel keypad switches.

Dual D-Type Flip-flops U307, 312, and 313 are used to store interrupt requests from the gated integrator RAM circuit. The processor can then identify the source of an interrupt through U303.

Jumpers J301 and J302 are used to select the type of oscillator that is installed in the receiver.

### **Gated Integrators (p. 5/14)**

There are four gated integrators used to integrate the incoming LORAN signal. All of the integrators are basically the same, so the following description will refer to components in the first integrator. Capacitor C401 integrates the output of U401A, an LM13600 Operational Transconductance Amplifier(OTA). The input to the OTA is the LORAN signal. The output of the OTA is turned on only when U410A is turned on by a -GATE1 signal. In this manner, integration of the LORAN signal occurs only during the time the gate is active, which allows integrating over any specified interval on the LORAN pulse. To discharge the integrating capacitor, switch U403A is kept closed until just before a gate occurs. The charge on the integrating capacitor is buffered to the analog-to-digital converter multiplexer by U402. The amplifier is configured for unity gain, but resistor divider R403 and R404 limits the maximum output level fed to the A/D converter.

Because the phase of specific LORAN pulses changes, U51 allows the inputs to the last three integrators to be switched between the inverting and non-inverting OTA inputs, thus ensuring that the sign of the integrator outputs can be controlled. The last two integrators also have a provision for integrating over a ten-times longer interval by having larger integrating capacitors C405 and C406 switched onto the OTA output by switches U409A and U409B.

### **Gated Integrator Pattern Ram (p. 6/14)**

The GATE, CARRIER, and CLEAR lines for the gated integrators are generated by clocking through a pattern stored in U506, an 8 kilobyte static RAM. The processor loads the memory locations through U510, an Octal Bus Transceiver, and the integrators are driven through U509, an Octal D-Type Flip-Flop. U508 is a multiplexer that generates the required control logic for writing and reading. U503 through U505 and U507B form a 13-bit counter that counts up from 3192 decimal, selecting the top 5000 RAM addresses. At the 200 ns period of the 5 MHz clock, this gives a 1 ms repeat time, which is the separation between LORAN pulses. The multiplexer U508 selects -GATE \_CS as

the counter clock for loading the RAM contents with a pattern, and 5\_MHz as the clock during integration. Flip-flop U507A is used to synchronize the start of the timing cycle with the Group Repetition Interval (GRI) of the LORAN chain being monitored, as well as to load the counters synchronously with the 100 kHz clock signal.

Two rear-panel outputs are provided to facilitate viewing the receiver output and tracking point. J501 is the "GRI OUT" output, and during receiver lock provides a 10  $\mu$ sec wide negative-going pulse 500 msec ahead of the third zero-crossing tracking point. J502 is the "GATE OUT" output, and during receiver lock provides a 10  $\mu$ sec wide negative-going pulse coincident with the third zero-crossing tracking point.

### **A/D, D/A Converters (p. 7/14)**

There is one 8-bit analog-to-digital converter and one 8-bit and one 16-bit digital-to-analog converter used in the FS700. The 16-bit serial DAC (U604) is used to generate an analog voltage that is used to discipline the internal 10 MHz oscillator. P601 is used to trim the MSB differential non-linearity of the DAC.

The 8-bit DAC (1/2 of U603) generates an analog control voltage to control the contrast of the front panel LCD. This voltage is buffered and multiplied to  $\pm 5$  V by U605A. The other half of U603 is an 8-bit A/D converter used to digitize the four gated integrator outputs, the output of the front-end detector, the V\_PHASE output from the phase detector, and the V\_ANT signal from the front end peak detector. The signal to be digitized is selected by multiplexer U602 and buffered and level shifted by U605C and U605D and then fed to the A/D converter.

### **Clocks and Clock Outputs (p. 8/14)**

The standard timebase is an ovenized voltage-controlled crystal oscillator that connects to J705 and provides a 10 MHz sine wave output. This oscillator exhibits  $5 \times 10^{-10}$  per day aging and  $2 \times 10^{-7}$  stability over  $0^\circ - 50^\circ$  C. In place of the standard oscillator, a higher short-term stability SC cut ovenized oscillator is available.

The 10 MHz sine wave from the installed oscillator is coupled to Q701 which in turn couples to emitter followers U703A-U703D. These transistors couple the 10 MHz reference to the rear panel outputs through the 10 MHz tanks (C702 and L701 typical of all four outputs). This provides a clean 10 MHz, 1 V rms sine wave into a 50 ohm load. The 10 MHz output is also buffered through Q702 to U701, a high-speed comparator which provides the 10 MHz clock used by the system.

### **Phase Comparators / Frequency Output (p. 9/14)**



Phase comparison is provided by U803, an ECL Phase-Frequency Detector. The external frequency input at J801 is discriminated by comparator U809 and coupled through ECL Line Receivers U805C and U805D to one input of the phase detector. The other input is from the frequency output selected by fast multiplexer U806, and is coupled through ECL line receivers U805A and U805B. A bipolar analog output from U804D indicating the relative phase of the two inputs is provided to the system A/D, and is buffered by U804A and provided to the front panel VPHASE output J803.

The 10 MHz system clock is divided by U807 and U808 to provide frequency outputs of 5 MHz, and 100 kHz. These frequencies, along with the 10 MHz source and the outputs from the programmable counters (see sheet 3) are provided as inputs to U806, the fast multiplexer. The multiplexer output is the Frequency Output used for phase comparison, and is buffered through U810 to the front panel BNC J802. The 5 MHz system clock is derived from the 10 MHz source and buffered by U203E.

The 100 kHz calibration signal that is fed to the front end calibration relay is derived from the OUT\_FREQ1 counter output. The signal is attenuated and filtered by R824, R816, and C808 and AC-coupled through C807. R829 is a pull-down to satisfy the antenna error detection circuitry.

### **Front Panel LED's / Switches (p. 10/14)**

The front panel LED indicators are connected to +5 V through resistor network N702, and are controlled by eight lines from latch U43 (Sheet 4). The eight switch lines are normally held low through resistor network N701. A key press is detected by scanning the REM, NUM, and CURS LED control lines and reading the switch input port. Diodes D709, D710, and D711 prevent simultaneous key presses from shorting LED lines together.

### **Unregulated Power Supplies (p. 11/14)**

The power entry module configures the unit to line voltages of 100, 120, 220, or 240 VAC and provides fuse protection and an RF interference filter. An 130 VAC Metal Oxide Varistor across the 120 VAC transformer primary provides spike and surge protection for the unit, and additionally protects against inadvertent connection to 220 or 240 VAC when configured for 100 or 120 VAC.

Full-wave rectification of the center-tapped secondary outputs of T1 provides unregulated +7 V and  $\pm 20$  V. Schottky diodes D902 and D903 are used in the +7 volt supply to reduce rectifier losses. Diode bridge D901 is used for the +20 and -20 volt supplies.

The unregulated supplies operate as long as the unit is connected to AC power. This is to provide uninterrupted power to the time base

oscillator. The power switch on the front panel acts only to enable the unit's power supply regulators.

### **Power Supply Regulators (p. 12/14)**

The 5 volt supply is regulated by pass transistor Q902. The base of this transistor is controlled by U907 to maintain the output at 5 volts. U907A compares the output (emitter) side of Q902 with the output of U905, which serves as a 5 volt reference. Because the current gain of Q902 remains high until the collector-emitter voltage drops to about .4 volts, the regulator exhibits a very low drop out voltage. The current drawn by the +5 volt supply is sensed by the voltage drop across R917, an 0.1 ohm resistor. When the current drawn exceeds about 1 amp, comparator U909A turns on, pulling the reference input to U907A below ground and turning off the regulator's output. The 5 V power required by the unit is provided by three-terminal regulator U908.

Regulators U901 and U902 provide +15 and -15 volt regulated outputs. The output of these regulators drops to about 1.25 volts when the front panel power switch SW901 is opened. This also turns off the +5 V supply, as the drive and reference for +5 V is obtained from the +15 volt supply. Regulators U903 and U904 are always on which provides  $\pm 15$  volts to the timebase.

In addition to the power supply voltages, there are also two status bits generated. - DROPOUT is asserted if the +5 V supply falls below 4.6 V, or if the +15 V supply falls below 11.5 volts. The - RESET line is asserted if the +5 V supply is below 4.4 V, or has been in the previous 1 second.

### **Active Antenna (p. 14/14)**

The active antenna electronics are located at the base of the antenna, and provide filtering as well as drive for the antenna lead-in cable. L1, L3, L4, and C1-C3 form a 3rd order Bessel bandpass filter for the 100 kHz LORAN-C signal. R1 and R2 provide a manually jumper-selectable 30 dB attenuator for use where strong signal levels might saturate the FET (Q1). Neon bulb LP1 protects Q1 from high-voltage discharges. Q1 drives the coaxial lead-in cable, and DC power for the FET stage is provided on the same coax.

# FS700 PARTS LIST

## FS700 Main Board/Front Panel Board

### Main Board and Front Panel Parts List

<u>REF.</u>	<u>SRS PART</u>	<u>VALUE</u>	<u>DESCRIPTION</u>
BT201	6-00001-612	BR-2/3A 2PIN PC	Battery
C 1	5-00100-517	2.2U	Capacitor, Tantalum, 35V, 20%, Rad
C 2	5-00100-517	2.2U	Capacitor, Tantalum, 35V, 20%, Rad
C 3	5-00100-517	2.2U	Capacitor, Tantalum, 35V, 20%, Rad
C 4	5-00100-517	2.2U	Capacitor, Tantalum, 35V, 20%, Rad
C 5	5-00100-517	2.2U	Capacitor, Tantalum, 35V, 20%, Rad
C 6	5-00225-548	.1U AXIAL	Capacitor, Ceramic, 50V,+80/-20% Z5U AX
C 7	5-00225-548	.1U AXIAL	Capacitor, Ceramic, 50V,+80/-20% Z5U AX
C 8	5-00225-548	.1U AXIAL	Capacitor, Ceramic, 50V,+80/-20% Z5U AX
C 9	5-00225-548	.1U AXIAL	Capacitor, Ceramic, 50V,+80/-20% Z5U AX
C 10	5-00225-548	.1U AXIAL	Capacitor, Ceramic, 50V,+80/-20% Z5U AX
C 11	5-00225-548	.1U AXIAL	Capacitor, Ceramic, 50V,+80/-20% Z5U AX
C 12	5-00023-529	.1U	Cap, Monolythic Ceramic, 50V, 20%, Z5U
C 13	5-00023-529	.1U	Cap, Monolythic Ceramic, 50V, 20%, Z5U
C 14	5-00023-529	.1U	Cap, Monolythic Ceramic, 50V, 20%, Z5U
C 15	5-00023-529	.1U	Cap, Monolythic Ceramic, 50V, 20%, Z5U
C 16	5-00023-529	.1U	Cap, Monolythic Ceramic, 50V, 20%, Z5U
C 17	5-00023-529	.1U	Cap, Monolythic Ceramic, 50V, 20%, Z5U
C 18	5-00023-529	.1U	Cap, Monolythic Ceramic, 50V, 20%, Z5U
C 19	5-00023-529	.1U	Cap, Monolythic Ceramic, 50V, 20%, Z5U
C 20	5-00023-529	.1U	Cap, Monolythic Ceramic, 50V, 20%, Z5U
C 21	5-00023-529	.1U	Cap, Monolythic Ceramic, 50V, 20%, Z5U
C 22	5-00225-548	.1U AXIAL	Capacitor, Ceramic, 50V,+80/-20% Z5U AX
C 23	5-00023-529	.1U	Cap, Monolythic Ceramic, 50V, 20%, Z5U
C 24	5-00225-548	.1U AXIAL	Capacitor, Ceramic, 50V,+80/-20% Z5U AX
C 25	5-00023-529	.1U	Cap, Monolythic Ceramic, 50V, 20%, Z5U
C 26	5-00225-548	.1U AXIAL	Capacitor, Ceramic, 50V,+80/-20% Z5U AX
C 27	5-00225-548	.1U AXIAL	Capacitor, Ceramic, 50V,+80/-20% Z5U AX
C 28	5-00225-548	.1U AXIAL	Capacitor, Ceramic, 50V,+80/-20% Z5U AX
C 29	5-00023-529	.1U	Cap, Monolythic Ceramic, 50V, 20%, Z5U
C 30	5-00023-529	.1U	Cap, Monolythic Ceramic, 50V, 20%, Z5U
C 31	5-00023-529	.1U	Cap, Monolythic Ceramic, 50V, 20%, Z5U
C 32	5-00023-529	.1U	Cap, Monolythic Ceramic, 50V, 20%, Z5U
C 33	5-00225-548	.1U AXIAL	Capacitor, Ceramic, 50V,+80/-20% Z5U AX
C 34	5-00225-548	.1U AXIAL	Capacitor, Ceramic, 50V,+80/-20% Z5U AX
C 35	5-00225-548	.1U AXIAL	Capacitor, Ceramic, 50V,+80/-20% Z5U AX
C 36	5-00225-548	.1U AXIAL	Capacitor, Ceramic, 50V,+80/-20% Z5U AX
C 38	5-00098-517	10U	Capacitor, Tantalum, 35V, 20%, Rad
C 101	5-00100-517	2.2U	Capacitor, Tantalum, 35V, 20%, Rad
C 102	5-00148-545	1000P	Capacitor, Monolythic Ceramic, COG, 1%
C 103	5-00023-529	.1U	Cap, Monolythic Ceramic, 50V, 20%, Z5U
C 104	5-00220-529	47P	Cap, Monolythic Ceramic, 50V, 20%, Z5U
C 105	5-00220-529	47P	Cap, Monolythic Ceramic, 50V, 20%, Z5U
C 106	5-00220-529	47P	Cap, Monolythic Ceramic, 50V, 20%, Z5U

<u>REF.</u>	<u>SRS PART</u>	<u>VALUE</u>	<u>DESCRIPTION</u>
C 107	5-00220-529	47P	Cap, Monolythic Ceramic, 50V, 20%, Z5U
C 108	5-00220-529	47P	Cap, Monolythic Ceramic, 50V, 20%, Z5U
C 109	5-00220-529	47P	Cap, Monolythic Ceramic, 50V, 20%, Z5U
C 110	5-00220-529	47P	Cap, Monolythic Ceramic, 50V, 20%, Z5U
C 111	5-00220-529	47P	Cap, Monolythic Ceramic, 50V, 20%, Z5U
C 112	5-00220-529	47P	Cap, Monolythic Ceramic, 50V, 20%, Z5U
C 113	5-00220-529	47P	Cap, Monolythic Ceramic, 50V, 20%, Z5U
C 114	5-00138-558	200P	Cap, Monolythic Ceramic, 50V, COG, 10%
C 115	5-00218-529	120P	Cap, Monolythic Ceramic, 50V, 20%, Z5U
C 116	5-00224-500	5-255P	Capacitor, Misc.
C 117	5-00224-500	5-255P	Capacitor, Misc.
C 118	5-00224-500	5-255P	Capacitor, Misc.
C 119	5-00224-500	5-255P	Capacitor, Misc.
C 120	5-00224-500	5-255P	Capacitor, Misc.
C 121	5-00224-500	5-255P	Capacitor, Misc.
C 122	5-00220-529	47P	Cap, Monolythic Ceramic, 50V, 20%, Z5U
C 123	5-00220-529	47P	Cap, Monolythic Ceramic, 50V, 20%, Z5U
C 124	5-00023-529	.1U	Cap, Monolythic Ceramic, 50V, 20%, Z5U
C 125	5-00022-501	.001U	Capacitor, Ceramic Disc, 50V, 10%, SL
C 126	5-00222-529	180P	Cap, Monolythic Ceramic, 50V, 20%, Z5U
C 127	5-00218-529	120P	Cap, Monolythic Ceramic, 50V, 20%, Z5U
C 128	5-00221-529	330P	Cap, Monolythic Ceramic, 50V, 20%, Z5U
C 129	5-00023-529	.1U	Cap, Monolythic Ceramic, 50V, 20%, Z5U
C 130	5-00023-529	.1U	Cap, Monolythic Ceramic, 50V, 20%, Z5U
C 131	5-00023-529	.1U	Cap, Monolythic Ceramic, 50V, 20%, Z5U
C 133	5-00134-529	100P	Cap, Monolythic Ceramic, 50V, 20%, Z5U
C 201	5-00023-529	.1U	Cap, Monolythic Ceramic, 50V, 20%, Z5U
C 202	5-00225-548	.1U AXIAL	Capacitor, Ceramic, 50V,+80/-20% Z5U AX
C 401	5-00114-501	200P	Capacitor, Ceramic Disc, 50V, 10%, SL
C 402	5-00114-501	200P	Capacitor, Ceramic Disc, 50V, 10%, SL
C 403	5-00239-562	680P	Cap., NPO Monolithic Ceramic, 50v, 5% Ra
C 404	5-00239-562	680P	Cap., NPO Monolithic Ceramic, 50v, 5% Ra
C 405	5-00062-513	.0022U	Capacitor, Mylar/Poly, 50V, 5%, Rad
C 406	5-00062-513	.0022U	Capacitor, Mylar/Poly, 50V, 5%, Rad
C 503	5-00100-517	2.2U	Capacitor, Tantalum, 35V, 20%, Rad
C 504	5-00134-529	100P	Cap, Monolythic Ceramic, 50V, 20%, Z5U
C 505	5-00100-517	2.2U	Capacitor, Tantalum, 35V, 20%, Rad
C 506	5-00134-529	100P	Cap, Monolythic Ceramic, 50V, 20%, Z5U
C 602	5-00225-548	.1U AXIAL	Capacitor, Ceramic, 50V,+80/-20% Z5U AX
C 603	5-00225-548	.1U AXIAL	Capacitor, Ceramic, 50V,+80/-20% Z5U AX
C 604	5-00099-517	1U	Capacitor, Tantalum, 35V, 20%, Rad
C 605	5-00099-517	1U	Capacitor, Tantalum, 35V, 20%, Rad
C 606	5-00099-517	1U	Capacitor, Tantalum, 35V, 20%, Rad
C 607	5-00099-517	1U	Capacitor, Tantalum, 35V, 20%, Rad
C 608	5-00023-529	.1U	Cap, Monolythic Ceramic, 50V, 20%, Z5U
C 609	5-00023-529	.1U	Cap, Monolythic Ceramic, 50V, 20%, Z5U
C 701	5-00132-501	56P	Capacitor, Ceramic Disc, 50V, 10%, SL
C 702	5-00132-501	56P	Capacitor, Ceramic Disc, 50V, 10%, SL
C 703	5-00132-501	56P	Capacitor, Ceramic Disc, 50V, 10%, SL
C 704	5-00132-501	56P	Capacitor, Ceramic Disc, 50V, 10%, SL

<u>REF.</u>	<u>SRS PART</u>	<u>VALUE</u>	<u>DESCRIPTION</u>
C 705	5-00132-501	56P	Capacitor, Ceramic Disc, 50V, 10%, SL
C 706	5-00023-529	.1U	Cap, Monolythic Ceramic, 50V, 20%, Z5U
C 707	5-00225-548	.1U AXIAL	Capacitor, Ceramic, 50V,+80/-20% Z5U AX
C 708	5-00225-548	.1U AXIAL	Capacitor, Ceramic, 50V,+80/-20% Z5U AX
C 709	5-00098-517	10U	Capacitor, Tantalum, 35V, 20%, Rad
C 710	5-00098-517	10U	Capacitor, Tantalum, 35V, 20%, Rad
C 711	5-00023-529	.1U	Cap, Monolythic Ceramic, 50V, 20%, Z5U
C 712	5-00023-529	.1U	Cap, Monolythic Ceramic, 50V, 20%, Z5U
C 720	5-00132-501	56P	Capacitor, Ceramic Disc, 50V, 10%, SL
C 801	5-00134-529	100P	Cap, Monolythic Ceramic, 50V, 20%, Z5U
C 802	5-00225-548	.1U AXIAL	Capacitor, Ceramic, 50V,+80/-20% Z5U AX
C 803	5-00225-548	.1U AXIAL	Capacitor, Ceramic, 50V,+80/-20% Z5U AX
C 804	5-00225-548	.1U AXIAL	Capacitor, Ceramic, 50V,+80/-20% Z5U AX
C 805	5-00225-548	.1U AXIAL	Capacitor, Ceramic, 50V,+80/-20% Z5U AX
C 806	5-00100-517	2.2U	Capacitor, Tantalum, 35V, 20%, Rad
C 807	5-00023-529	.1U	Cap, Monolythic Ceramic, 50V, 20%, Z5U
C 808	5-00022-501	.001U	Capacitor, Ceramic Disc, 50V, 10%, SL
C 809	5-00023-529	.1U	Cap, Monolythic Ceramic, 50V, 20%, Z5U
C 810	5-00023-529	.1U	Cap, Monolythic Ceramic, 50V, 20%, Z5U
C 811	5-00098-517	10U	Capacitor, Tantalum, 35V, 20%, Rad
C 812	5-00023-529	.1U	Cap, Monolythic Ceramic, 50V, 20%, Z5U
C 813	5-00134-529	100P	Cap, Monolythic Ceramic, 50V, 20%, Z5U
C 814	5-00100-517	2.2U	Capacitor, Tantalum, 35V, 20%, Rad
C 815	5-00023-529	.1U	Cap, Monolythic Ceramic, 50V, 20%, Z5U
C 816	5-00023-529	.1U	Cap, Monolythic Ceramic, 50V, 20%, Z5U
C 817	5-00065-513	.01U	Capacitor, Mylar/Poly, 50V, 5%, Rad
C 818	5-00065-513	.01U	Capacitor, Mylar/Poly, 50V, 5%, Rad
C 901	5-00201-526	2200U	Capacitor, Electrolytic, 35V, 20%, Rad
C 902	5-00212-520	15000U	Capacitor, Electrolytic, 16V, 20%, Rad
C 903	5-00201-526	2200U	Capacitor, Electrolytic, 35V, 20%, Rad
C 904	5-00038-509	10U	Capacitor, Electrolytic, 50V, 20%, Rad
C 905	5-00192-542	22U MIN	Cap, Mini Electrolytic, 50V, 20% Radial
C 906	5-00192-542	22U MIN	Cap, Mini Electrolytic, 50V, 20% Radial
C 907	5-00038-509	10U	Capacitor, Electrolytic, 50V, 20%, Rad
C 908	5-00100-517	2.2U	Capacitor, Tantalum, 35V, 20%, Rad
C 910	5-00038-509	10U	Capacitor, Electrolytic, 50V, 20%, Rad
C 911	5-00098-517	10U	Capacitor, Tantalum, 35V, 20%, Rad
C 912	5-00098-517	10U	Capacitor, Tantalum, 35V, 20%, Rad
C 913	5-00134-529	100P	Cap, Monolythic Ceramic, 50V, 20%, Z5U
C 914	5-00023-529	.1U	Cap, Monolythic Ceramic, 50V, 20%, Z5U
C 915	5-00038-509	10U	Capacitor, Electrolytic, 50V, 20%, Rad
C 916	5-00100-517	2.2U	Capacitor, Tantalum, 35V, 20%, Rad
C 917	5-00038-509	10U	Capacitor, Electrolytic, 50V, 20%, Rad
C 918	5-00023-529	.1U	Cap, Monolythic Ceramic, 50V, 20%, Z5U
C 919	5-00225-548	.1U AXIAL	Capacitor, Ceramic, 50V,+80/-20% Z5U AX
C 920	5-00225-548	.1U AXIAL	Capacitor, Ceramic, 50V,+80/-20% Z5U AX
C 921	5-00225-548	.1U AXIAL	Capacitor, Ceramic, 50V,+80/-20% Z5U AX
C 922	5-00225-548	.1U AXIAL	Capacitor, Ceramic, 50V,+80/-20% Z5U AX
C 923	5-00225-548	.1U AXIAL	Capacitor, Ceramic, 50V,+80/-20% Z5U AX
C 924	5-00225-548	.1U AXIAL	Capacitor, Ceramic, 50V,+80/-20% Z5U AX

C 925	5-00023-529	.1U	Cap, Monolythic Ceramic, 50V, 20%, Z5U
C 926	5-00225-548	.1U AXIAL	Capacitor, Ceramic, 50V,+80/-20% Z5U AX
C 927	5-00225-548	.1U AXIAL	Capacitor, Ceramic, 50V,+80/-20% Z5U AX
<b>REF.</b>	<b>SRS PART</b>	<b>VALUE</b>	<b>DESCRIPTION</b>
C 928	5-00023-529	.1U	Cap, Monolythic Ceramic, 50V, 20%, Z5U
C 929	5-00225-548	.1U AXIAL	Capacitor, Ceramic, 50V,+80/-20% Z5U AX
C 930	5-00225-548	.1U AXIAL	Capacitor, Ceramic, 50V,+80/-20% Z5U AX
C 931	5-00225-548	.1U AXIAL	Capacitor, Ceramic, 50V,+80/-20% Z5U AX
C 932	5-00225-548	.1U AXIAL	Capacitor, Ceramic, 50V,+80/-20% Z5U AX
C 933	5-00225-548	.1U AXIAL	Capacitor, Ceramic, 50V,+80/-20% Z5U AX
C 934	5-00225-548	.1U AXIAL	Capacitor, Ceramic, 50V,+80/-20% Z5U AX
C 935	5-00225-548	.1U AXIAL	Capacitor, Ceramic, 50V,+80/-20% Z5U AX
C 936	5-00225-548	.1U AXIAL	Capacitor, Ceramic, 50V,+80/-20% Z5U AX
C 937	5-00225-548	.1U AXIAL	Capacitor, Ceramic, 50V,+80/-20% Z5U AX
C 938	5-00225-548	.1U AXIAL	Capacitor, Ceramic, 50V,+80/-20% Z5U AX
C 939	5-00225-548	.1U AXIAL	Capacitor, Ceramic, 50V,+80/-20% Z5U AX
C 940	5-00225-548	.1U AXIAL	Capacitor, Ceramic, 50V,+80/-20% Z5U AX
C 941	5-00225-548	.1U AXIAL	Capacitor, Ceramic, 50V,+80/-20% Z5U AX
C 942	5-00225-548	.1U AXIAL	Capacitor, Ceramic, 50V,+80/-20% Z5U AX
C 943	5-00225-548	.1U AXIAL	Capacitor, Ceramic, 50V,+80/-20% Z5U AX
C 944	5-00225-548	.1U AXIAL	Capacitor, Ceramic, 50V,+80/-20% Z5U AX
C 945	5-00225-548	.1U AXIAL	Capacitor, Ceramic, 50V,+80/-20% Z5U AX
C 946	5-00225-548	.1U AXIAL	Capacitor, Ceramic, 50V,+80/-20% Z5U AX
C 947	5-00225-548	.1U AXIAL	Capacitor, Ceramic, 50V,+80/-20% Z5U AX
C 948	5-00225-548	.1U AXIAL	Capacitor, Ceramic, 50V,+80/-20% Z5U AX
C 949	5-00225-548	.1U AXIAL	Capacitor, Ceramic, 50V,+80/-20% Z5U AX
C 950	5-00225-548	.1U AXIAL	Capacitor, Ceramic, 50V,+80/-20% Z5U AX
C 951	5-00225-548	.1U AXIAL	Capacitor, Ceramic, 50V,+80/-20% Z5U AX
C 952	5-00225-548	.1U AXIAL	Capacitor, Ceramic, 50V,+80/-20% Z5U AX
C 953	5-00225-548	.1U AXIAL	Capacitor, Ceramic, 50V,+80/-20% Z5U AX
C 954	5-00225-548	.1U AXIAL	Capacitor, Ceramic, 50V,+80/-20% Z5U AX
C 955	5-00100-517	2.2U	Capacitor, Tantalum, 35V, 20%, Rad
C 956	5-00100-517	2.2U	Capacitor, Tantalum, 35V, 20%, Rad
C 957	5-00100-517	2.2U	Capacitor, Tantalum, 35V, 20%, Rad
C 958	5-00100-517	2.2U	Capacitor, Tantalum, 35V, 20%, Rad
C 959	5-00100-517	2.2U	Capacitor, Tantalum, 35V, 20%, Rad
C 960	5-00100-517	2.2U	Capacitor, Tantalum, 35V, 20%, Rad
C 961	5-00100-517	2.2U	Capacitor, Tantalum, 35V, 20%, Rad
C 962	5-00100-517	2.2U	Capacitor, Tantalum, 35V, 20%, Rad
C 963	5-00100-517	2.2U	Capacitor, Tantalum, 35V, 20%, Rad
C 964	5-00100-517	2.2U	Capacitor, Tantalum, 35V, 20%, Rad
C 965	5-00100-517	2.2U	Capacitor, Tantalum, 35V, 20%, Rad
C 966	5-00100-517	2.2U	Capacitor, Tantalum, 35V, 20%, Rad
C 967	5-00100-517	2.2U	Capacitor, Tantalum, 35V, 20%, Rad
C 968	5-00100-517	2.2U	Capacitor, Tantalum, 35V, 20%, Rad
C 969	5-00023-529	.1U	Cap, Monolythic Ceramic, 50V, 20%, Z5U
C 970	5-00023-529	.1U	Cap, Monolythic Ceramic, 50V, 20%, Z5U
C 971	5-00023-529	.1U	Cap, Monolythic Ceramic, 50V, 20%, Z5U
C 972	5-00023-529	.1U	Cap, Monolythic Ceramic, 50V, 20%, Z5U
C 973	5-00225-548	.1U AXIAL	Capacitor, Ceramic, 50V,+80/-20% Z5U AX
C 974	5-00023-529	.1U	Cap, Monolythic Ceramic, 50V, 20%, Z5U

<u>REF.</u>	<u>SRS PART</u>	<u>VALUE</u>	<u>DESCRIPTION</u>
C 975	5-00023-529	.1U	Cap, Monolythic Ceramic, 50V, 20%, Z5U
C 976	5-00023-529	.1U	Cap, Monolythic Ceramic, 50V, 20%, Z5U
C 977	5-00100-517	2.2U	Capacitor, Tantalum, 35V, 20%, Rad
C 978	5-00100-517	2.2U	Capacitor, Tantalum, 35V, 20%, Rad
C 979	5-00100-517	2.2U	Capacitor, Tantalum, 35V, 20%, Rad
C 980	5-00100-517	2.2U	Capacitor, Tantalum, 35V, 20%, Rad
C 981	5-00100-517	2.2U	Capacitor, Tantalum, 35V, 20%, Rad
C 982	5-00225-548	.1U AXIAL	Capacitor, Ceramic, 50V,+80/-20% Z5U AX
C 983	5-00023-529	.1U	Cap, Monolythic Ceramic, 50V, 20%, Z5U
C 984	5-00023-529	.1U	Cap, Monolythic Ceramic, 50V, 20%, Z5U
C 985	5-00225-548	.1U AXIAL	Capacitor, Ceramic, 50V,+80/-20% Z5U AX
C 986	5-00225-548	.1U AXIAL	Capacitor, Ceramic, 50V,+80/-20% Z5U AX
C 987	5-00023-529	.1U	Cap, Monolythic Ceramic, 50V, 20%, Z5U
C 988	5-00023-529	.1U	Cap, Monolythic Ceramic, 50V, 20%, Z5U
C 989	5-00023-529	.1U	Cap, Monolythic Ceramic, 50V, 20%, Z5U
C 990	5-00023-529	.1U	Cap, Monolythic Ceramic, 50V, 20%, Z5U
C 991	5-00023-529	.1U	Cap, Monolythic Ceramic, 50V, 20%, Z5U
C 992	5-00023-529	.1U	Cap, Monolythic Ceramic, 50V, 20%, Z5U
C 993	5-00023-529	.1U	Cap, Monolythic Ceramic, 50V, 20%, Z5U
C 994	5-00023-529	.1U	Cap, Monolythic Ceramic, 50V, 20%, Z5U
C 995	5-00225-548	.1U AXIAL	Capacitor, Ceramic, 50V,+80/-20% Z5U AX
C 996	5-00225-548	.1U AXIAL	Capacitor, Ceramic, 50V,+80/-20% Z5U AX
C 997	5-00225-548	.1U AXIAL	Capacitor, Ceramic, 50V,+80/-20% Z5U AX
CP1000	5-00027-503	.01U	Capacitor, Ceramic Disc, 50V, 20%, Z5U
D 10	3-00885-306	YELLOW	LED, Rectangular
D 11	3-00012-306	GREEN	LED, Rectangular
D 12	3-00012-306	GREEN	LED, Rectangular
D 13	3-00013-306	RED	LED, Rectangular
D 14	3-00012-306	GREEN	LED, Rectangular
D 15	3-00013-306	RED	LED, Rectangular
D 16	3-00885-306	YELLOW	LED, Rectangular
D 17	3-00012-306	GREEN	LED, Rectangular
D 101	3-00203-301	1N5711	Diode
D 201	3-00004-301	1N4148	Diode
D 202	3-00004-301	1N4148	Diode
D 203	3-00004-301	1N4148	Diode
D 204	3-00198-301	1N5231B	Diode
D 709	3-00004-301	1N4148	Diode
D 710	3-00004-301	1N4148	Diode
D 711	3-00004-301	1N4148	Diode
D 801	3-00004-301	1N4148	Diode
D 802	3-00203-301	1N5711	Diode
D 803	3-00004-301	1N4148	Diode
D 901	3-00062-340	KBP201G/BR-81D	Integrated Circuit (Thru-hole Pkg)
D 902	3-00226-301	1N5822	Diode
D 903	3-00226-301	1N5822	Diode
D 904	4-00541-435	130V/1200A	Varistor, Zinc Oxide Nonlinear Resistor
D 905	3-00226-301	1N5822	Diode
F 901	6-00004-611	1A 3AG	Fuse
J 201	1-00146-130	14 PIN ELH	Connector, Male

J 202	1-00238-161	GPIB SHIELDED	Connector, IEEE488, Reverse, R/A, Female
J 300	1-00010-130	20 PIN ELH	Connector, Male
JP104	1-00006-130	2 PIN DI	Connector, Male
JP105	1-00006-130	2 PIN DI	Connector, Male
JP106	1-00006-130	2 PIN DI	Connector, Male
<b>REF.</b>	<b>SRS PART</b>	<b>VALUE</b>	<b>DESCRIPTION</b>
JP107	1-00006-130	2 PIN DI	Connector, Male
JP301	1-00006-130	2 PIN DI	Connector, Male
JP302	1-00006-130	2 PIN DI	Connector, Male
K 101	3-00196-335	HS-212S-5	Relay
L 101	6-00062-606	6.8MH	Inductor, Variable
L 102	6-00062-606	6.8MH	Inductor, Variable
L 103	6-00062-606	6.8MH	Inductor, Variable
L 104	6-00062-606	6.8MH	Inductor, Variable
L 105	6-00062-606	6.8MH	Inductor, Variable
L 106	6-00062-606	6.8MH	Inductor, Variable
L 107	6-00063-606	39MH	Inductor, Variable
L 108	6-00063-606	39MH	Inductor, Variable
L 109	6-00063-606	39MH	Inductor, Variable
L 110	6-00063-606	39MH	Inductor, Variable
L 111	6-00063-606	39MH	Inductor, Variable
L 112	6-00063-606	39MH	Inductor, Variable
L 113	6-00061-606	2.7MH	Inductor, Variable
L 114	6-00060-606	22MH	Inductor, Variable
L 115	6-00066-606	8.2MH	Inductor, Variable
L 116	6-00060-606	22MH	Inductor, Variable
L 117	6-00065-606	12MH	Inductor, Variable
L 118	6-00066-606	8.2MH	Inductor, Variable
L 119	6-00028-604	10UH	Inductor, Vertical Mount
L 120	6-00028-604	10UH	Inductor, Vertical Mount
L 501	6-00055-630	FB43-1801	Ferrite Beads
L 502	6-00055-630	FB43-1801	Ferrite Beads
L 701	6-00048-603	4.7UH	Inductor, Axial
L 702	6-00048-603	4.7UH	Inductor, Axial
L 703	6-00048-603	4.7UH	Inductor, Axial
L 704	6-00048-603	4.7UH	Inductor, Axial
L 705	6-00048-603	4.7UH	Inductor, Axial
L 706	6-00048-603	4.7UH	Inductor, Axial
L 801	6-00028-604	10UH	Inductor, Vertical Mount
N 401	4-00247-425	100X9	Resistor Network SIP 1/4W 2% (Common)
N 402	4-00586-420	2.2KX7	Resistor Network, DIP, 1/4W,2%,8 Ind
N 701	4-00336-425	270X5	Resistor Network SIP 1/4W 2% (Common)
N 801	4-00298-425	470X5	Resistor Network SIP 1/4W 2% (Common)
N 804	4-00298-425	470X5	Resistor Network SIP 1/4W 2% (Common)
OS1	5-00023-529	.1U	Cap, Monolythic Ceramic, 50V, 20%, Z5U
OS2	5-00023-529	.1U	Cap, Monolythic Ceramic, 50V, 20%, Z5U
OS3	5-00100-517	2.2U	Capacitor, Tantalum, 35V, 20%, Rad
P 601	4-00617-441	100K	Pot, Multi-Turn Trim, 3/8" Square Top Ad
PC1	7-00401-701	FS700/800	Printed Circuit Board
PC2	7-00076-701	DG535-32	Printed Circuit Board
Q 101	3-00021-325	2N3904	Transistor, TO-92 Package



Q 102	3-00177-321	2N2222	Transistor, TO-18 Package
Q 201	3-00140-325	2N2369A	Transistor, TO-92 Package
Q 301	3-00021-325	2N3904	Transistor, TO-92 Package
Q 701	3-00022-325	2N3906	Transistor, TO-92 Package
Q 702	3-00021-325	2N3904	Transistor, TO-92 Package
Q 801	3-00021-325	2N3904	Transistor, TO-92 Package
<b>REF.</b>	<b>SRS PART</b>	<b>VALUE</b>	<b>DESCRIPTION</b>
Q 802	3-00021-325	2N3904	Transistor, TO-92 Package
Q 902	3-00378-329	TIP102	Voltage Reg., TO-220 (TAB) Package
R 101	4-00348-407	2.21K	Resistor, Metal Film, 1/8W, 1%, 50PPM
R 102	4-00348-407	2.21K	Resistor, Metal Film, 1/8W, 1%, 50PPM
R 103	4-00467-407	2.43K	Resistor, Metal Film, 1/8W, 1%, 50PPM
R 104	4-00429-407	511	Resistor, Metal Film, 1/8W, 1%, 50PPM
R 105	4-00380-407	6.34K	Resistor, Metal Film, 1/8W, 1%, 50PPM
R 106	4-00080-401	47	Resistor, Carbon Film, 1/4W, 5%
R 107	4-00322-407	316	Resistor, Metal Film, 1/8W, 1%, 50PPM
R 108	4-00068-401	300	Resistor, Carbon Film, 1/4W, 5%
R 109	4-00068-401	300	Resistor, Carbon Film, 1/4W, 5%
R 110	4-00068-401	300	Resistor, Carbon Film, 1/4W, 5%
R 111	4-00068-401	300	Resistor, Carbon Film, 1/4W, 5%
R 112	4-00068-401	300	Resistor, Carbon Film, 1/4W, 5%
R 113	4-00068-401	300	Resistor, Carbon Film, 1/4W, 5%
R 114	4-00352-401	1.6K	Resistor, Carbon Film, 1/4W, 5%
R 115	4-00352-401	1.6K	Resistor, Carbon Film, 1/4W, 5%
R 116	4-00352-401	1.6K	Resistor, Carbon Film, 1/4W, 5%
R 117	4-00352-401	1.6K	Resistor, Carbon Film, 1/4W, 5%
R 118	4-00352-401	1.6K	Resistor, Carbon Film, 1/4W, 5%
R 119	4-00352-401	1.6K	Resistor, Carbon Film, 1/4W, 5%
R 120	4-00186-407	4.22K	Resistor, Metal Film, 1/8W, 1%, 50PPM
R 121	4-00655-407	665	Resistor, Metal Film, 1/8W, 1%, 50PPM
R 122	4-00144-407	107	Resistor, Metal Film, 1/8W, 1%, 50PPM
R 123	4-00356-407	20	Resistor, Metal Film, 1/8W, 1%, 50PPM
R 124	4-00031-401	100	Resistor, Carbon Film, 1/4W, 5%
R 125	4-00138-407	10.0K	Resistor, Metal Film, 1/8W, 1%, 50PPM
R 126	4-00516-407	14.3K	Resistor, Metal Film, 1/8W, 1%, 50PPM
R 127	4-00429-407	511	Resistor, Metal Film, 1/8W, 1%, 50PPM
R 128	4-00380-407	6.34K	Resistor, Metal Film, 1/8W, 1%, 50PPM
R 129	4-00429-407	511	Resistor, Metal Film, 1/8W, 1%, 50PPM
R 130	4-00380-407	6.34K	Resistor, Metal Film, 1/8W, 1%, 50PPM
R 131	4-00380-407	6.34K	Resistor, Metal Film, 1/8W, 1%, 50PPM
R 132	4-00429-407	511	Resistor, Metal Film, 1/8W, 1%, 50PPM
R 133	4-00652-407	1.58K	Resistor, Metal Film, 1/8W, 1%, 50PPM
R 134	4-00169-407	249	Resistor, Metal Film, 1/8W, 1%, 50PPM
R 135	4-00204-407	750	Resistor, Metal Film, 1/8W, 1%, 50PPM
R 136	4-00580-407	475	Resistor, Metal Film, 1/8W, 1%, 50PPM
R 137	4-00180-407	301	Resistor, Metal Film, 1/8W, 1%, 50PPM
R 138	4-00653-407	205	Resistor, Metal Film, 1/8W, 1%, 50PPM
R 139	4-00135-407	1.50K	Resistor, Metal Film, 1/8W, 1%, 50PPM
R 141	4-00546-407	40.2	Resistor, Metal Film, 1/8W, 1%, 50PPM
R 142	4-00525-407	7.5	Resistor, Metal Film, 1/8W, 1%, 50PPM
R 143	4-00429-407	511	Resistor, Metal Film, 1/8W, 1%, 50PPM

R 144	4-00526-407	232	Resistor, Metal Film, 1/8W, 1%, 50PPM
R 145	4-00654-407	182	Resistor, Metal Film, 1/8W, 1%, 50PPM
R 146	4-00048-401	2.2K	Resistor, Carbon Film, 1/4W, 5%
R 147	4-00027-401	1.5K	Resistor, Carbon Film, 1/4W, 5%
R 148	4-00021-401	1.0K	Resistor, Carbon Film, 1/4W, 5%
R 149	4-00034-401	10K	Resistor, Carbon Film, 1/4W, 5%
R 150	4-00021-401	1.0K	Resistor, Carbon Film, 1/4W, 5%
<b>REF.</b>	<b>SRS PART</b>	<b>VALUE</b>	<b>DESCRIPTION</b>
R 151	4-00057-401	220	Resistor, Carbon Film, 1/4W, 5%
R 152	4-00034-401	10K	Resistor, Carbon Film, 1/4W, 5%
R 153	4-00034-401	10K	Resistor, Carbon Film, 1/4W, 5%
R 201	4-00034-401	10K	Resistor, Carbon Film, 1/4W, 5%
R 202	4-00079-401	4.7K	Resistor, Carbon Film, 1/4W, 5%
R 203	4-00021-401	1.0K	Resistor, Carbon Film, 1/4W, 5%
R 204	4-00081-401	470	Resistor, Carbon Film, 1/4W, 5%
R 205	4-00065-401	3.3K	Resistor, Carbon Film, 1/4W, 5%
R 206	4-00027-401	1.5K	Resistor, Carbon Film, 1/4W, 5%
R 301	4-00079-401	4.7K	Resistor, Carbon Film, 1/4W, 5%
R 302	4-00079-401	4.7K	Resistor, Carbon Film, 1/4W, 5%
R 401	4-00188-407	4.99K	Resistor, Metal Film, 1/8W, 1%, 50PPM
R 402	4-00305-401	4.3K	Resistor, Carbon Film, 1/4W, 5%
R 403	4-00027-401	1.5K	Resistor, Carbon Film, 1/4W, 5%
R 404	4-00021-401	1.0K	Resistor, Carbon Film, 1/4W, 5%
R 405	4-00021-401	1.0K	Resistor, Carbon Film, 1/4W, 5%
R 406	4-00027-401	1.5K	Resistor, Carbon Film, 1/4W, 5%
R 407	4-00021-401	1.0K	Resistor, Carbon Film, 1/4W, 5%
R 408	4-00188-407	4.99K	Resistor, Metal Film, 1/8W, 1%, 50PPM
R 409	4-00027-401	1.5K	Resistor, Carbon Film, 1/4W, 5%
R 410	4-00021-401	1.0K	Resistor, Carbon Film, 1/4W, 5%
R 411	4-00048-401	2.2K	Resistor, Carbon Film, 1/4W, 5%
R 412	4-00048-401	2.2K	Resistor, Carbon Film, 1/4W, 5%
R 413	4-00048-401	2.2K	Resistor, Carbon Film, 1/4W, 5%
R 414	4-00188-407	4.99K	Resistor, Metal Film, 1/8W, 1%, 50PPM
R 415	4-00188-407	4.99K	Resistor, Metal Film, 1/8W, 1%, 50PPM
R 416	4-00034-401	10K	Resistor, Carbon Film, 1/4W, 5%
R 417	4-00034-401	10K	Resistor, Carbon Film, 1/4W, 5%
R 418	4-00034-401	10K	Resistor, Carbon Film, 1/4W, 5%
R 419	4-00034-401	10K	Resistor, Carbon Film, 1/4W, 5%
R 420	4-00042-401	15K	Resistor, Carbon Film, 1/4W, 5%
R 421	4-00042-401	15K	Resistor, Carbon Film, 1/4W, 5%
R 422	4-00042-401	15K	Resistor, Carbon Film, 1/4W, 5%
R 423	4-00042-401	15K	Resistor, Carbon Film, 1/4W, 5%
R 424	4-00027-401	1.5K	Resistor, Carbon Film, 1/4W, 5%
R 501	4-00112-402	47	Resistor, Carbon Comp, 1/2W, 5%
R 502	4-00112-402	47	Resistor, Carbon Comp, 1/2W, 5%
R 503	4-00021-401	1.0K	Resistor, Carbon Film, 1/4W, 5%
R 504	4-00021-401	1.0K	Resistor, Carbon Film, 1/4W, 5%
R 602	4-00138-407	10.0K	Resistor, Metal Film, 1/8W, 1%, 50PPM
R 603	4-00034-401	10K	Resistor, Carbon Film, 1/4W, 5%
R 604	4-00021-401	1.0K	Resistor, Carbon Film, 1/4W, 5%
R 605	4-00034-401	10K	Resistor, Carbon Film, 1/4W, 5%

<u>REF.</u>	<u>SRS PART</u>	<u>VALUE</u>	<u>DESCRIPTION</u>
R 606	4-00021-401	1.0K	Resistor, Carbon Film, 1/4W, 5%
R 607	4-00138-407	10.0K	Resistor, Metal Film, 1/8W, 1%, 50PPM
R 608	4-00034-401	10K	Resistor, Carbon Film, 1/4W, 5%
R 609	4-00055-401	20K	Resistor, Carbon Film, 1/4W, 5%
R 610	4-00473-407	11.0K	Resistor, Metal Film, 1/8W, 1%, 50PPM
R 611	4-00607-407	3.92K	Resistor, Metal Film, 1/8W, 1%, 50PPM
R 612	4-00138-407	10.0K	Resistor, Metal Film, 1/8W, 1%, 50PPM
R 613	4-00082-401	470K	Resistor, Carbon Film, 1/4W, 5%
R 614	4-00054-401	200K	Resistor, Carbon Film, 1/4W, 5%
R 701	4-00021-401	1.0K	Resistor, Carbon Film, 1/4W, 5%
R 702	4-00138-407	10.0K	Resistor, Metal Film, 1/8W, 1%, 50PPM
R 703	4-00196-407	6.04K	Resistor, Metal Film, 1/8W, 1%, 50PPM
R 704	4-00138-407	10.0K	Resistor, Metal Film, 1/8W, 1%, 50PPM
R 705	4-00550-407	16.5K	Resistor, Metal Film, 1/8W, 1%, 50PPM
R 706	4-00086-401	51	Resistor, Carbon Film, 1/4W, 5%
R 707	4-00585-401	36	Resistor, Carbon Film, 1/4W, 5%
R 708	4-00145-407	110	Resistor, Metal Film, 1/8W, 1%, 50PPM
R 709	4-00585-401	36	Resistor, Carbon Film, 1/4W, 5%
R 710	4-00080-401	47	Resistor, Carbon Film, 1/4W, 5%
R 711	4-00585-401	36	Resistor, Carbon Film, 1/4W, 5%
R 712	4-00585-401	36	Resistor, Carbon Film, 1/4W, 5%
R 713	4-00031-401	100	Resistor, Carbon Film, 1/4W, 5%
R 714	4-00031-401	100	Resistor, Carbon Film, 1/4W, 5%
R 715	4-00031-401	100	Resistor, Carbon Film, 1/4W, 5%
R 716	4-00031-401	100	Resistor, Carbon Film, 1/4W, 5%
R 717	4-00585-401	36	Resistor, Carbon Film, 1/4W, 5%
R 718	4-00080-401	47	Resistor, Carbon Film, 1/4W, 5%
R 719	4-00585-401	36	Resistor, Carbon Film, 1/4W, 5%
R 720	4-00057-401	220	Resistor, Carbon Film, 1/4W, 5%
R 721	4-00021-401	1.0K	Resistor, Carbon Film, 1/4W, 5%
R 722	4-00086-401	51	Resistor, Carbon Film, 1/4W, 5%
R 801	4-00138-407	10.0K	Resistor, Metal Film, 1/8W, 1%, 50PPM
R 802	4-00138-407	10.0K	Resistor, Metal Film, 1/8W, 1%, 50PPM
R 803	4-00057-401	220	Resistor, Carbon Film, 1/4W, 5%
R 804	4-00192-407	49.9K	Resistor, Metal Film, 1/8W, 1%, 50PPM
R 805	4-00192-407	49.9K	Resistor, Metal Film, 1/8W, 1%, 50PPM
R 806	4-00269-407	4.64K	Resistor, Metal Film, 1/8W, 1%, 50PPM
R 807	4-00269-407	4.64K	Resistor, Metal Film, 1/8W, 1%, 50PPM
R 808	4-00081-401	470	Resistor, Carbon Film, 1/4W, 5%
R 809	4-00081-401	470	Resistor, Carbon Film, 1/4W, 5%
R 810	4-00034-401	10K	Resistor, Carbon Film, 1/4W, 5%
R 811	4-00192-407	49.9K	Resistor, Metal Film, 1/8W, 1%, 50PPM
R 812	4-00192-407	49.9K	Resistor, Metal Film, 1/8W, 1%, 50PPM
R 813	4-00038-401	120	Resistor, Carbon Film, 1/4W, 5%
R 814	4-00080-401	47	Resistor, Carbon Film, 1/4W, 5%
R 815	4-00053-401	200	Resistor, Carbon Film, 1/4W, 5%
R 816	4-00656-407	63.4	Resistor, Metal Film, 1/8W, 1%, 50PPM
R 817	4-00030-401	10	Resistor, Carbon Film, 1/4W, 5%
R 818	4-00021-401	1.0K	Resistor, Carbon Film, 1/4W, 5%
R 819	4-00071-401	33	Resistor, Carbon Film, 1/4W, 5%

R 820	4-00031-401	100	Resistor, Carbon Film, 1/4W, 5%
R 821	4-00030-401	10	Resistor, Carbon Film, 1/4W, 5%
R 822	4-00021-401	1.0K	Resistor, Carbon Film, 1/4W, 5%
R 823	4-00112-402	47	Resistor, Carbon Comp, 1/2W, 5%
R 824	4-00379-407	5.76K	Resistor, Metal Film, 1/8W, 1%, 50PPM
R 825	4-00087-401	510	Resistor, Carbon Film, 1/4W, 5%
R 826	4-00081-401	470	Resistor, Carbon Film, 1/4W, 5%
R 827	4-00071-401	33	Resistor, Carbon Film, 1/4W, 5%
R 828	4-00087-401	510	Resistor, Carbon Film, 1/4W, 5%
<b>REF.</b>	<b>SRS PART</b>	<b>VALUE</b>	<b>DESCRIPTION</b>
R 829	4-00580-407	475	Resistor, Metal Film, 1/8W, 1%, 50PPM
R 830	4-00130-407	1.00K	Resistor, Metal Film, 1/8W, 1%, 50PPM
R 831	4-00130-407	1.00K	Resistor, Metal Film, 1/8W, 1%, 50PPM
R 832	4-00138-407	10.0K	Resistor, Metal Film, 1/8W, 1%, 50PPM
R 833	4-00138-407	10.0K	Resistor, Metal Film, 1/8W, 1%, 50PPM
R 834	4-00130-407	1.00K	Resistor, Metal Film, 1/8W, 1%, 50PPM
R 835	4-00138-407	10.0K	Resistor, Metal Film, 1/8W, 1%, 50PPM
R 836	4-00130-407	1.00K	Resistor, Metal Film, 1/8W, 1%, 50PPM
R 837	4-00138-407	10.0K	Resistor, Metal Film, 1/8W, 1%, 50PPM
R 901	4-00032-401	100K	Resistor, Carbon Film, 1/4W, 5%
R 902	4-00034-401	10K	Resistor, Carbon Film, 1/4W, 5%
R 903	4-00021-401	1.0K	Resistor, Carbon Film, 1/4W, 5%
R 904	4-00417-407	2.74K	Resistor, Metal Film, 1/8W, 1%, 50PPM
R 905	4-00169-407	249	Resistor, Metal Film, 1/8W, 1%, 50PPM
R 906	4-00439-407	1.33K	Resistor, Metal Film, 1/8W, 1%, 50PPM
R 907	4-00149-407	121	Resistor, Metal Film, 1/8W, 1%, 50PPM
R 908	4-00042-401	15K	Resistor, Carbon Film, 1/4W, 5%
R 909	4-00034-401	10K	Resistor, Carbon Film, 1/4W, 5%
R 910	4-00061-401	240K	Resistor, Carbon Film, 1/4W, 5%
R 911	4-00034-401	10K	Resistor, Carbon Film, 1/4W, 5%
R 912	4-00059-401	22K	Resistor, Carbon Film, 1/4W, 5%
R 913	4-00021-401	1.0K	Resistor, Carbon Film, 1/4W, 5%
R 914	4-00059-401	22K	Resistor, Carbon Film, 1/4W, 5%
R 915	4-00034-401	10K	Resistor, Carbon Film, 1/4W, 5%
R 916	4-00034-401	10K	Resistor, Carbon Film, 1/4W, 5%
R 917	4-00436-409	0.1	Resistor, Wire Wound
R 918	4-00021-401	1.0K	Resistor, Carbon Film, 1/4W, 5%
R 919	4-00074-401	33K	Resistor, Carbon Film, 1/4W, 5%
RK1	7-00141-740	DG535-27	Keypad, Conductive Rubber
RN701	4-00276-425	10KX9	Resistor Network SIP 1/4W 2% (Common)
RN702	4-00226-425	150X9	Resistor Network SIP 1/4W 2% (Common)
RP1000	4-00030-401	10	Resistor, Carbon Film, 1/4W, 5%
SO207	1-00026-150	28 PIN 600 MIL	Socket, THRU-HOLE
SW901	2-00033-218	DPDT	Switch, Panel Mount, Power, Rocker
T 901	6-00039-610	SR620/FS700	Transformer
U 101	3-00371-340	DG444	Integrated Circuit (Thru-hole Pkg)
U 102	3-00089-340	LF357	Integrated Circuit (Thru-hole Pkg)
U 103	3-00088-340	LF353	Integrated Circuit (Thru-hole Pkg)
U 104	3-00088-340	LF353	Integrated Circuit (Thru-hole Pkg)
U 105	3-00088-340	LF353	Integrated Circuit (Thru-hole Pkg)
U 106	3-00088-340	LF353	Integrated Circuit (Thru-hole Pkg)

U 107	3-00088-340	LF353	Integrated Circuit (Thru-hole Pkg)
U 108	3-00088-340	LF353	Integrated Circuit (Thru-hole Pkg)
U 109	3-00371-340	DG444	Integrated Circuit (Thru-hole Pkg)
U 110	3-00089-340	LF357	Integrated Circuit (Thru-hole Pkg)
U 111	3-00371-340	DG444	Integrated Circuit (Thru-hole Pkg)
U 112	3-00089-340	LF357	Integrated Circuit (Thru-hole Pkg)
U 113	3-00371-340	DG444	Integrated Circuit (Thru-hole Pkg)
U 114	3-00089-340	LF357	Integrated Circuit (Thru-hole Pkg)
U 116	3-00088-340	LF353	Integrated Circuit (Thru-hole Pkg)
U 201	3-00299-341	32KX8-70L	STATIC RAM, I.C.
<b>REF.</b>	<b>SRS PART</b>	<b>VALUE</b>	<b>DESCRIPTION</b>
U 202	3-00298-340	Z84C0008PEC	Integrated Circuit (Thru-hole Pkg)
U 203	3-00155-340	74HC04	Integrated Circuit (Thru-hole Pkg)
U 204	3-00158-340	74HC154N	Integrated Circuit (Thru-hole Pkg)
U 205	3-00387-340	74HC245	Integrated Circuit (Thru-hole Pkg)
U 206	3-00045-340	74HC32	Integrated Circuit (Thru-hole Pkg)
U 208	3-00492-340	UPD71054C-10	Integrated Circuit (Thru-hole Pkg)
U 209	3-00645-340	NAT9914BPD	Integrated Circuit (Thru-hole Pkg)
U 210	3-00078-340	DS75160A	Integrated Circuit (Thru-hole Pkg)
U 211	3-00079-340	DS75161A	Integrated Circuit (Thru-hole Pkg)
U 212	3-00037-340	74HC138	Integrated Circuit (Thru-hole Pkg)
U 213	3-00043-340	74HC21	Integrated Circuit (Thru-hole Pkg)
U 301	3-00046-340	74HC374	Integrated Circuit (Thru-hole Pkg)
U 302	3-00044-340	74HC244	Integrated Circuit (Thru-hole Pkg)
U 303	3-00044-340	74HC244	Integrated Circuit (Thru-hole Pkg)
U 304	3-00046-340	74HC374	Integrated Circuit (Thru-hole Pkg)
U 305	3-00046-340	74HC374	Integrated Circuit (Thru-hole Pkg)
U 306	3-00046-340	74HC374	Integrated Circuit (Thru-hole Pkg)
U 307	3-00049-340	74HC74	Integrated Circuit (Thru-hole Pkg)
U 308	3-00182-340	74HC02	Integrated Circuit (Thru-hole Pkg)
U 309	3-00046-340	74HC374	Integrated Circuit (Thru-hole Pkg)
U 310	3-00492-340	UPD71054C-10	Integrated Circuit (Thru-hole Pkg)
U 311	3-00165-340	74HC08	Integrated Circuit (Thru-hole Pkg)
U 312	3-00049-340	74HC74	Integrated Circuit (Thru-hole Pkg)
U 313	3-00049-340	74HC74	Integrated Circuit (Thru-hole Pkg)
U 401	3-00093-340	LM13600	Integrated Circuit (Thru-hole Pkg)
U 402	3-00066-340	CA3140E	Integrated Circuit (Thru-hole Pkg)
U 403	3-00371-340	DG444	Integrated Circuit (Thru-hole Pkg)
U 404	3-00066-340	CA3140E	Integrated Circuit (Thru-hole Pkg)
U 405	3-00093-340	LM13600	Integrated Circuit (Thru-hole Pkg)
U 406	3-00066-340	CA3140E	Integrated Circuit (Thru-hole Pkg)
U 407	3-00066-340	CA3140E	Integrated Circuit (Thru-hole Pkg)
U 408	3-00331-340	CD4053	Integrated Circuit (Thru-hole Pkg)
U 409	3-00371-340	DG444	Integrated Circuit (Thru-hole Pkg)
U 410	3-00332-340	MPQ3906	Integrated Circuit (Thru-hole Pkg)
U 503	3-00333-340	74HC161	Integrated Circuit (Thru-hole Pkg)
U 504	3-00333-340	74HC161	Integrated Circuit (Thru-hole Pkg)
U 505	3-00333-340	74HC161	Integrated Circuit (Thru-hole Pkg)
U 506	3-00157-341	8KX8-100 LOW	STATIC RAM, I.C.
U 507	3-00049-340	74HC74	Integrated Circuit (Thru-hole Pkg)
U 508	3-00040-340	74HC157	Integrated Circuit (Thru-hole Pkg)

U 509	3-00046-340	74HC374	Integrated Circuit (Thru-hole Pkg)
U 510	3-00387-340	74HC245	Integrated Circuit (Thru-hole Pkg)
U 511	3-00155-340	74HC04	Integrated Circuit (Thru-hole Pkg)
U 512	3-00155-340	74HC04	Integrated Circuit (Thru-hole Pkg)
U 602	3-00270-340	74HC4051	Integrated Circuit (Thru-hole Pkg)
U 603	3-00334-340	AD7569	Integrated Circuit (Thru-hole Pkg)
U 604	3-00335-340	PCM56	Integrated Circuit (Thru-hole Pkg)
U 605	3-00087-340	LF347	Integrated Circuit (Thru-hole Pkg)
U 606	3-00088-340	LF353	Integrated Circuit (Thru-hole Pkg)
U 701	3-00211-340	LT1016	Integrated Circuit (Thru-hole Pkg)
U 703	3-00338-340	MPQ3904	Integrated Circuit (Thru-hole Pkg)
<b>REF.</b>	<b>SRS PART</b>	<b>VALUE</b>	<b>DESCRIPTION</b>
U 803	3-00154-340	MC12040	Integrated Circuit (Thru-hole Pkg)
U 804	3-00087-340	LF347	Integrated Circuit (Thru-hole Pkg)
U 805	3-00210-340	MC10H115	Integrated Circuit (Thru-hole Pkg)
U 806	3-00336-340	74F151	Integrated Circuit (Thru-hole Pkg)
U 807	3-00337-340	74F160	Integrated Circuit (Thru-hole Pkg)
U 808	3-00337-340	74F160	Integrated Circuit (Thru-hole Pkg)
U 809	3-00388-340	LT685	Integrated Circuit (Thru-hole Pkg)
U 810	3-00155-340	74HC04	Integrated Circuit (Thru-hole Pkg)
U 901	3-00149-329	LM317T	Voltage Reg., TO-220 (TAB) Package
U 902	3-00141-329	LM337T	Voltage Reg., TO-220 (TAB) Package
U 903	3-00114-329	7815	Voltage Reg., TO-220 (TAB) Package
U 905	3-00116-325	78L05	Transistor, TO-92 Package
U 906	3-00185-340	LM2901	Integrated Circuit (Thru-hole Pkg)
U 907	3-00088-340	LF353	Integrated Circuit (Thru-hole Pkg)
U 908	3-00119-329	7905	Voltage Reg., TO-220 (TAB) Package
U 909	3-00143-340	LM393	Integrated Circuit (Thru-hole Pkg)
X 1	6-00051-622	10 MHZ	Ovenized Crystal Oscillator
Z 0	0-00011-057	GROMMET	Grommet
Z 0	0-00014-002	6J4	Power_Entry Hardware
Z 0	0-00017-002	TRANSCOVER	Power_Entry Hardware
Z 0	0-00025-005	3/8"	Lugs
Z 0	0-00043-011	4-40 KEP	Nut, Kep
Z 0	0-00048-011	6-32 KEP	Nut, Kep
Z 0	0-00079-031	4-40X3/16 M/F	Standoff
Z 0	0-00089-033	4"	Tie
Z 0	0-00096-041	#4 SPLIT	Washer, Split
Z 0	0-00097-040	#6 FLAT	Washer, Flat
Z 0	0-00104-043	#4 NYLON	Washer, nylon
Z 0	0-00109-050	1-1/2" #18	Wire #18 UL1007 Stripped 3/8x3/8 No Tin
Z 0	0-00113-053	10" #24	Wire #24 UL1007 Strip 1/4x1/4 Tin
Z 0	0-00115-053	11" #24	Wire #24 UL1007 Strip 1/4x1/4 Tin
Z 0	0-00133-052	7-1/2" #22	Wire #22 UL1007
Z 0	0-00136-053	8-1/2" #24	Wire #24 UL1007 Strip 1/4x1/4 Tin
Z 0	0-00150-026	4-40X1/4PF	Screw, Black, All Types
Z 0	0-00153-057	GROMMET2	Grommet
Z 0	0-00165-003	TO-18	Insulators
Z 0	0-00173-044	CLEAR 2	Window
Z 0	0-00186-021	6-32X1-3/8PP	Screw, Panhead Phillips
Z 0	0-00187-021	4-40X1/4PP	Screw, Panhead Phillips

Z 0	0-00231-043	#4 SHOULDER	Washer, nylon
Z 0	0-00233-000	HANDLE1	Hardware, Misc.
Z 0	0-00238-026	6-32X1/4PF	Screw, Black, All Types
Z 0	0-00240-026	4-40X3/8PF	Screw, Black, All Types
Z 0	0-00243-003	TO-220	Insulators
Z 0	0-00256-043	#6 SHOULDER	Washer, nylon
Z 0	0-00259-021	4-40X1/2"PP	Screw, Panhead Phillips
Z 0	0-00287-053	8.5 #24 GRN	Wire #24 UL1007 Strip 1/4x1/4 Tin
Z 0	0-00352-000	BUTTON COVER	Hardware, Misc.
Z 0	0-00359-060	2.6X6MM	Screw, Misc
Z 0	0-00366-053	10" #24	Wire #24 UL1007 Strip 1/4x1/4 Tin
Z 0	0-00407-032	SOLDR SLV RG174	Termination
<b>REF.</b>	<b>SRS PART</b>	<b>VALUE</b>	<b>DESCRIPTION</b>
Z 0	0-00432-000	CNCTR CUTOUT	Hardware, Misc.
Z 0	0-00468-000	STRAP, CONNECT	Hardware, Misc.
Z 0	0-00500-000	554808-1	Hardware, Misc.
Z 0	0-00522-053	3-1/2" #24	Wire #24 UL1007 Strip 1/4x1/4 Tin
Z 0	0-00526-048	10-1/2" #18	Wire, #18 UL1015 Strip 3/8 x 3/8 No Tin
Z 0	0-00893-026	8-32X3/8PF	Screw, Black, All Types
Z 0	1-00003-120	BNC	Connector, BNC
Z 0	1-00011-130	20 PIN IDP	Connector, Male
Z 0	1-00047-130	14 PIN IDP	Connector, Male
Z 0	1-00051-171	20 COND	Cable Assembly, Ribbon
Z 0	1-00066-112	7 PIN; 24AWG/WH	Connector, Amp, MTA-100
Z 0	1-00073-120	INSL	Connector, BNC
Z 0	1-00144-131	14 PIN DIF POL	Connector, Female
Z 0	1-00145-131	20 PIN DIF POL	Connector, Female
Z 0	6-00079-622	10 MHZ HS	Ovenized Crystal Oscillator
Z 0	6-00088-613	NE-2H	Lamp
Z 0	7-00198-720	SR510-23	Fabricated Part
Z 0	7-00201-720	SR500-32	Fabricated Part
Z 0	7-00202-720	SR500-33	Fabricated Part
Z 0	7-00205-720	SR510-26	Fabricated Part
Z 0	7-00255-709	FS700	Lexan Overlay
Z 0	7-00264-710	FS700-6	Front Panel
Z 0	7-00265-720	FS700-7,8	Fabricated Part
Z 0	7-00333-720	FS700-11	Fabricated Part
Z 0	8-00032-820	LM110A2C3CSY	LCD Display
Z 0	9-00262-917	FS700 SERIAL	Product Labels

### FS700 Active Antenna Parts List

<b>REF.</b>	<b>SRS PART</b>	<b>VALUE</b>	<b>DESCRIPTION</b>
AN1	0-00300-000	ANTENNA/FS700	Hardware, Misc.
C 1	5-00089-516	47P	Capacitor, Silver Mica, 500V, 5%,
C 2	5-00239-562	680P	Cap., NPO Monolithic Ceramic, 50v, 5% Ra
C 3	5-00222-529	180P	Cap, Monolythic Ceramic, 50V, 20%, Z5U
J 2	1-00148-170	BNC 2.5'	Cable Assembly, Multiconductor
L 1	6-00082-602	33MH	Inductor, Radial
L 2	6-00085-602	390UH	Inductor, Radial

L 3	6-00084-602	15MH	Inductor, Radial
L 4	6-00083-602	3.9MH	Inductor, Radial
PC1	7-00476-701	FS800 ANTENNA	Printed Circuit Board
Q 1	3-00029-325	2N5951	Transistor, TO-92 Package
R 1	4-00418-407	7.32K	Resistor, Metal Film, 1/8W, 1%, 50PPM
R 3	4-00032-401	100K	Resistor, Carbon Film, 1/4W, 5%
Z 0	0-00025-005	3/8"	Lugs
Z 0	0-00089-033	4"	Tie
Z 0	0-00348-040	3/8"X1"X1/16"	Washer, Flat
Z 0	0-00360-000	U-BRCK/ANTENNA	Hardware, Misc.
Z 0	0-00374-000	1-1/4X3/4	Hardware, Misc.
Z 0	0-00375-010	3/8/24	Nut, Hex
Z 0	0-00376-000	ANTENNA MOUNT	Hardware, Misc.
<b><u>REF.</u></b>	<b><u>SRS PART</u></b>	<b><u>VALUE</u></b>	<b><u>DESCRIPTION</u></b>
Z 0	1-00129-170	BNC 100' FS700	Cable Assembly, Multiconductor
Z 0	6-00088-613	NE-2H	Lamp
Z 0	7-00411-720	FS700-12	Fabricated Part
Z 0	9-00255-917	FS700 ANTENNA	Product Labels
Z 0	9-00326-907	3/4" BLK ADHES	Shrink Tubing
Z 0	9-00329-908	1495	Adhesives
Z 0	9-00330-908	CATALYST 9	Adhesives

#### Miscellaneous and Chassis Assembly Parts List

<b><u>REF.</u></b>	<b><u>SRS PART</u></b>	<b><u>VALUE</u></b>	<b><u>DESCRIPTION</u></b>
U 207	3-00229-342	27256-200	EPROM/PROM, I.C.
Z 0	0-00167-023	6-32X1/2RP	Screw, Roundhead Phillips
Z 0	0-00179-000	RIGHT FOOT	Hardware, Misc.
Z 0	0-00180-000	LEFT FOOT	Hardware, Misc.
Z 0	0-00185-021	6-32X3/8PP	Screw, Panhead Phillips
Z 0	0-00204-000	REAR FOOT	Hardware, Misc.
Z 0	0-00247-026	6-32X1/4 TRUSSP	Screw, Black, All Types
Z 0	0-00248-026	10-32X3/8TRUSSP	Screw, Black, All Types
Z 0	1-00087-131	2 PIN JUMPER	Connector, Female
Z 0	7-00147-720	BAIL	Fabricated Part
Z 0	7-00199-720	SR510-24	Fabricated Part
Z 0	7-00200-720	SR510-25	Fabricated Part



**INTRODUCTION**

The Model FS710 10 MHz AGC Distribution Amplifier provides seven sine wave outputs from a single 10 MHz source. Designed as an accessory to the FS700 LORAN Receiver, the

FS710 AGC circuitry compensates for up to 30 dB of cable loss. This makes the FS710 ideal for distributing a 10 MHz timebase as far as a mile from a FS700 receiver.

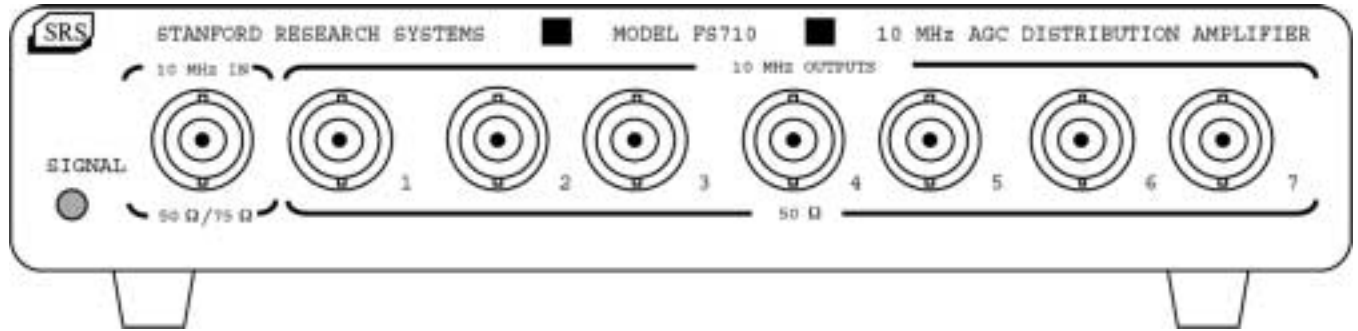

**Figure 1 – FS710 Front Panel**

**TYPICAL SPECIFICATIONS**

INPUT	Frequency:	10 MHz ±100 kHz
	Type:	Insulated BNC, transformer coupled
	Impedance:	50 Ω or 75 Ω (jumper selectable)
	Level:	35 mV to 5 VAC peak-to-peak
	VSWR:	< 1.2 at 10 MHz
OUTPUT	Type:	7 local grounded BNC's
	Level:	1 V peak-to-peak into 50 Ω, ±10% or 2 V peak-to-peak into 10 kΩ, ±10%
	VSWR:	< 1.2 at 10 MHz (50 Ω)
	Distortion:	< -30 dBc
MECHANICAL		7.75" x 7.5" x 2" (w x l x h)
WEIGHT		3 lbs.
POWER		100/120/220/240 VAC, 10 Watts, 50/60 Hz
WARRANTY		One year parts and labor on materials and workmanship.

## **OPERATION**

Normal operation is indicated by a green light in the lower left corner of the front panel. A red light indicates that the input signal is too low to maintain the set amplitude output.

## **TROUBLESHOOTING**

**WARNING:** Dangerous voltages are present on the printed circuit board. Always turn the power off and disconnect the line cord before removing the cover or changing components.

If front panel indicator is not lit, check the rear panel power switch, the power cord, and the fuse. If the Signal indicator is red, check for proper input signal frequency (10 MHz  $\pm$  1%) and sufficient amplitude. Also, check for opens and shorts on the input and output connections.

## **CALIBRATION**

Either J50 or J75 (not both) should be installed to match the input signal impedance (50 or 75 ohms, respectively). The output level can be set to any level from .75 to 1.25 volts peak to peak by adjusting P1. Of the 8 round holes in the top of the box, P1 is accessible through the right-rear position.

## **CIRCUIT DESCRIPTION**

T1, L101, C101, R101, and R102 comprise the input network and provide ground isolation, bandpass filtering, and impedance matching. The signal is amplified by U1 and further filtered by a "stagger tuned" network consisting of L103, C107, R105, C108, C109, and L102.

U2 controls the gain of U1 by comparing the peak voltage at L102 with the reference voltage from P1, R117 and R118. D1 indicates loss of signal (red) if the control voltage from U2 becomes less than -2.5 volts. Q8 buffers the signal for distribution to the output transistors Q1 through Q7. Final bandpass filtering and impedance matching is provided by L11-L71, C11-C71, and R11-R71.

## **LINE VOLTAGE SELECTION**

The FS710 operates from a 100, 120, 220 or 240 Volt AC nominal, 50 or 60 Hz power source. Before applying power, verify that the line selector card (located in the power entry module) is in the correct position. The selected voltage is indicated by the white dot on the voltage list.

To change the line voltage selection, disconnect the line cord and remove the fuse module with a small screwdriver. Pull out the voltage selection card (located at the right of the power entry module) with a pair of needle nose pliers. Rotate the plastic indicator until it lines up with the correct voltage indicated on the fuse holder and reinsert the card. Install the correct fuse, reinsert the fuse holder and replace the line cord.

## **LINE FUSE**

Verify that the correct line fuse is installed before connecting the line cord. The rear panel indicates the correct fuse size, 1/4 Amp @ 100/120 Volts or 1/8 Amp @ 220/240 Volts. If necessary the fuse can be changed as indicated in the line voltage selection section.

## FS710 PARTS LIST

<u>REF.</u>	<u>SRS PART</u>	<u>VALUE</u>	<u>DESCRIPTION</u>
C 11	5-00132-501	56P	Capacitor, Ceramic Disc, 50V, 10%, SL
C 12	5-00023-529	.1U	Cap, Monolythic Ceramic, 50V, 20%, Z5U
C 13	5-00023-529	.1U	Cap, Monolythic Ceramic, 50V, 20%, Z5U
C 21	5-00132-501	56P	Capacitor, Ceramic Disc, 50V, 10%, SL
C 22	5-00023-529	.1U	Cap, Monolythic Ceramic, 50V, 20%, Z5U
C 23	5-00023-529	.1U	Cap, Monolythic Ceramic, 50V, 20%, Z5U
C 31	5-00132-501	56P	Capacitor, Ceramic Disc, 50V, 10%, SL
C 32	5-00023-529	.1U	Cap, Monolythic Ceramic, 50V, 20%, Z5U
C 33	5-00023-529	.1U	Cap, Monolythic Ceramic, 50V, 20%, Z5U
C 41	5-00132-501	56P	Capacitor, Ceramic Disc, 50V, 10%, SL
C 42	5-00023-529	.1U	Cap, Monolythic Ceramic, 50V, 20%, Z5U
C 43	5-00023-529	.1U	Cap, Monolythic Ceramic, 50V, 20%, Z5U
C 51	5-00132-501	56P	Capacitor, Ceramic Disc, 50V, 10%, SL
C 52	5-00023-529	.1U	Cap, Monolythic Ceramic, 50V, 20%, Z5U
C 53	5-00023-529	.1U	Cap, Monolythic Ceramic, 50V, 20%, Z5U
C 61	5-00132-501	56P	Capacitor, Ceramic Disc, 50V, 10%, SL
C 62	5-00023-529	.1U	Cap, Monolythic Ceramic, 50V, 20%, Z5U
C 63	5-00023-529	.1U	Cap, Monolythic Ceramic, 50V, 20%, Z5U
C 71	5-00132-501	56P	Capacitor, Ceramic Disc, 50V, 10%, SL
C 72	5-00023-529	.1U	Cap, Monolythic Ceramic, 50V, 20%, Z5U
C 73	5-00023-529	.1U	Cap, Monolythic Ceramic, 50V, 20%, Z5U
C 101	5-00132-501	56P	Capacitor, Ceramic Disc, 50V, 10%, SL
C 102	5-00002-501	100P	Capacitor, Ceramic Disc, 50V, 10%, SL
C 103	5-00002-501	100P	Capacitor, Ceramic Disc, 50V, 10%, SL
C 104	5-00023-529	.1U	Cap, Monolythic Ceramic, 50V, 20%, Z5U
C 105	5-00023-529	.1U	Cap, Monolythic Ceramic, 50V, 20%, Z5U
C 106	5-00027-503	.01U	Capacitor, Ceramic Disc, 50V, 20%, Z5U
C 107	5-00015-501	39P	Capacitor, Ceramic Disc, 50V, 10%, SL
C 108	5-00003-501	10P	Capacitor, Ceramic Disc, 50V, 10%, SL
C 109	5-00015-501	39P	Capacitor, Ceramic Disc, 50V, 10%, SL
C 110	5-00027-503	.01U	Capacitor, Ceramic Disc, 50V, 20%, Z5U
C 111	5-00023-529	.1U	Cap, Monolythic Ceramic, 50V, 20%, Z5U
C 112	5-00027-503	.01U	Capacitor, Ceramic Disc, 50V, 20%, Z5U
C 113	5-00023-529	.1U	Cap, Monolythic Ceramic, 50V, 20%, Z5U
C 114	5-00027-503	.01U	Capacitor, Ceramic Disc, 50V, 20%, Z5U
C 115	5-00023-529	.1U	Cap, Monolythic Ceramic, 50V, 20%, Z5U
C 116	5-00100-517	2.2U	Capacitor, Tantalum, 35V, 20%, Rad
C 117	5-00100-517	2.2U	Capacitor, Tantalum, 35V, 20%, Rad
C 118	5-00100-517	2.2U	Capacitor, Tantalum, 35V, 20%, Rad
C 119	5-00100-517	2.2U	Capacitor, Tantalum, 35V, 20%, Rad
C 120	5-00030-520	2200U	Capacitor, Electrolytic, 16V, 20%, Rad
C 121	5-00030-520	2200U	Capacitor, Electrolytic, 16V, 20%, Rad
C 122	5-00083-516	200P	Capacitor, Silver Mica, 500V, 5%,
D 1	3-00377-305	GLPED2	LED, Rectangular, Bicolor
D 2	3-00203-301	1N5711	Diode
D 3	3-00203-301	1N5711	Diode
D 4	3-00062-340	KBP201G/BR-81D	Integrated Circuit (Thru-hole Pkg)
J 1	1-00003-120	BNC	Connector, BNC

<u>REF.</u>	<u>SRS PART</u>	<u>VALUE</u>	<u>DESCRIPTION</u>
J 2	1-00003-120	BNC	Connector, BNC
J 3	1-00003-120	BNC	Connector, BNC
J 4	1-00003-120	BNC	Connector, BNC
J 5	1-00003-120	BNC	Connector, BNC
J 6	1-00003-120	BNC	Connector, BNC
J 7	1-00003-120	BNC	Connector, BNC
J 8	1-00073-120	INSL	Connector, BNC
J 9	1-00065-114	7 PIN; WHITE	Header, Amp, MTA-100
J 50	0-00001-000	WIRE	Hardware, Misc.
L 11	6-00048-603	4.7UH	Inductor, Axial
L 21	6-00048-603	4.7UH	Inductor, Axial
L 31	6-00048-603	4.7UH	Inductor, Axial
L 41	6-00048-603	4.7UH	Inductor, Axial
L 51	6-00048-603	4.7UH	Inductor, Axial
L 61	6-00048-603	4.7UH	Inductor, Axial
L 71	6-00048-603	4.7UH	Inductor, Axial
L 101	6-00081-603	4.7UH	Inductor, Axial
L 102	6-00081-603	4.7UH	Inductor, Axial
L 103	6-00081-603	4.7UH	Inductor, Axial
P 1	4-00370-441	500	Pot, Multi-Turn Trim, 3/8" Square Top Ad
PC1	7-00332-701	FS710	Printed Circuit Board
Q 1	3-00021-325	2N3904	Transistor, TO-92 Package
Q 2	3-00021-325	2N3904	Transistor, TO-92 Package
Q 3	3-00021-325	2N3904	Transistor, TO-92 Package
Q 4	3-00021-325	2N3904	Transistor, TO-92 Package
Q 5	3-00021-325	2N3904	Transistor, TO-92 Package
Q 6	3-00021-325	2N3904	Transistor, TO-92 Package
Q 7	3-00021-325	2N3904	Transistor, TO-92 Package
Q 8	3-00197-321	2N2907	Transistor, TO-18 Package
Q 9	3-00022-325	2N3906	Transistor, TO-92 Package
Q 10	3-00022-325	2N3906	Transistor, TO-92 Package
R 11	4-00080-401	47	Resistor, Carbon Film, 1/4W, 5%
R 12	4-00062-401	270	Resistor, Carbon Film, 1/4W, 5%
R 13	4-00080-401	47	Resistor, Carbon Film, 1/4W, 5%
R 14	4-00080-401	47	Resistor, Carbon Film, 1/4W, 5%
R 21	4-00080-401	47	Resistor, Carbon Film, 1/4W, 5%
R 22	4-00062-401	270	Resistor, Carbon Film, 1/4W, 5%
R 23	4-00080-401	47	Resistor, Carbon Film, 1/4W, 5%
R 24	4-00080-401	47	Resistor, Carbon Film, 1/4W, 5%
R 31	4-00080-401	47	Resistor, Carbon Film, 1/4W, 5%
R 32	4-00062-401	270	Resistor, Carbon Film, 1/4W, 5%
R 33	4-00080-401	47	Resistor, Carbon Film, 1/4W, 5%
R 34	4-00080-401	47	Resistor, Carbon Film, 1/4W, 5%
R 41	4-00080-401	47	Resistor, Carbon Film, 1/4W, 5%
R 42	4-00062-401	270	Resistor, Carbon Film, 1/4W, 5%
R 43	4-00080-401	47	Resistor, Carbon Film, 1/4W, 5%
R 44	4-00080-401	47	Resistor, Carbon Film, 1/4W, 5%
R 51	4-00080-401	47	Resistor, Carbon Film, 1/4W, 5%
R 52	4-00062-401	270	Resistor, Carbon Film, 1/4W, 5%
R 53	4-00080-401	47	Resistor, Carbon Film, 1/4W, 5%

<u>REF.</u>	<u>SRS PART</u>	<u>VALUE</u>	<u>DESCRIPTION</u>
R 54	4-00080-401	47	Resistor, Carbon Film, 1/4W, 5%
R 61	4-00080-401	47	Resistor, Carbon Film, 1/4W, 5%
R 62	4-00062-401	270	Resistor, Carbon Film, 1/4W, 5%
R 63	4-00080-401	47	Resistor, Carbon Film, 1/4W, 5%
R 64	4-00080-401	47	Resistor, Carbon Film, 1/4W, 5%
R 71	4-00080-401	47	Resistor, Carbon Film, 1/4W, 5%
R 72	4-00062-401	270	Resistor, Carbon Film, 1/4W, 5%
R 73	4-00080-401	47	Resistor, Carbon Film, 1/4W, 5%
R 74	4-00080-401	47	Resistor, Carbon Film, 1/4W, 5%
R 101	4-00242-407	73.2	Resistor, Metal Film, 1/8W, 1%, 50PPM
R 102	4-00086-401	51	Resistor, Carbon Film, 1/4W, 5%
R 103	4-00074-401	33K	Resistor, Carbon Film, 1/4W, 5%
R 104	4-00080-401	47	Resistor, Carbon Film, 1/4W, 5%
R 105	4-00045-401	2.0K	Resistor, Carbon Film, 1/4W, 5%
R 106	4-00080-401	47	Resistor, Carbon Film, 1/4W, 5%
R 107	4-00080-401	47	Resistor, Carbon Film, 1/4W, 5%
R 108	4-00080-401	47	Resistor, Carbon Film, 1/4W, 5%
R 109	4-00057-401	220	Resistor, Carbon Film, 1/4W, 5%
R 110	4-00032-401	100K	Resistor, Carbon Film, 1/4W, 5%
R 111	4-00032-401	100K	Resistor, Carbon Film, 1/4W, 5%
R 112	4-00051-401	2.7K	Resistor, Carbon Film, 1/4W, 5%
R 113	4-00060-401	240	Resistor, Carbon Film, 1/4W, 5%
R 114	4-00071-401	33	Resistor, Carbon Film, 1/4W, 5%
R 115	4-00079-401	4.7K	Resistor, Carbon Film, 1/4W, 5%
R 116	4-00079-401	4.7K	Resistor, Carbon Film, 1/4W, 5%
R 117	4-00350-407	3.74K	Resistor, Metal Film, 1/8W, 1%, 50PPM
R 118	4-00204-407	750	Resistor, Metal Film, 1/8W, 1%, 50PPM
R 119	4-00057-401	220	Resistor, Carbon Film, 1/4W, 5%
R 120	4-00090-401	560	Resistor, Carbon Film, 1/4W, 5%
T 1	6-00009-610	T1-1-X65	Transformer
T 2	6-00077-610	SR445/FS710	Transformer
U 1	3-00386-340	MC1590	Integrated Circuit (Thru-hole Pkg)
U 2	3-00090-340	LF411	Integrated Circuit (Thru-hole Pkg)
U 3	3-00119-329	7905	Voltage Reg., TO-220 (TAB) Package
U 4	3-00112-329	7805	Voltage Reg., TO-220 (TAB) Package
Z 0	0-00043-011	4-40 KEP	Nut, Kep
Z 0	0-00108-054	1" #26	Wire #26 UL1061
Z 0	0-00165-003	TO-18	Insulators
Z 0	0-00187-021	4-40X1/4PP	Screw, Panhead Phillips
Z 0	0-00208-020	4-40X3/8PF	Screw, Flathead Phillips
Z 0	0-00209-021	4-40X3/8PP	Screw, Panhead Phillips
Z 0	0-00220-002	5EFM4S	Power_Entry Hardware
Z 0	0-00221-000	SR440FOOT	Hardware, Misc.
Z 0	0-00231-043	#4 SHOULDER	Washer, nylon
Z 0	0-00243-003	TO-220	Insulators
Z 0	0-00522-053	3-1/2" #24	Wire #24 UL1007 Strip 1/4x1/4 Tin
Z 0	0-00532-053	3-1/2 YEL NOTIN	Wire #24 UL1007 Strip 1/4x1/4 Tin
Z 0	1-00066-112	7 PIN; 24AWG/WH	Connector, Amp, MTA-100
Z 0	6-00002-611	.25A 3AG	Fuse
Z 0	7-00119-720	SR440-1	Fabricated Part

Z 0	7-00120-720	SR440-2	Fabricated Part
Z 0	7-00331-709	FS710-1	Lexan Overlay
Z 0	9-00267-917	GENERIC	Product Labels

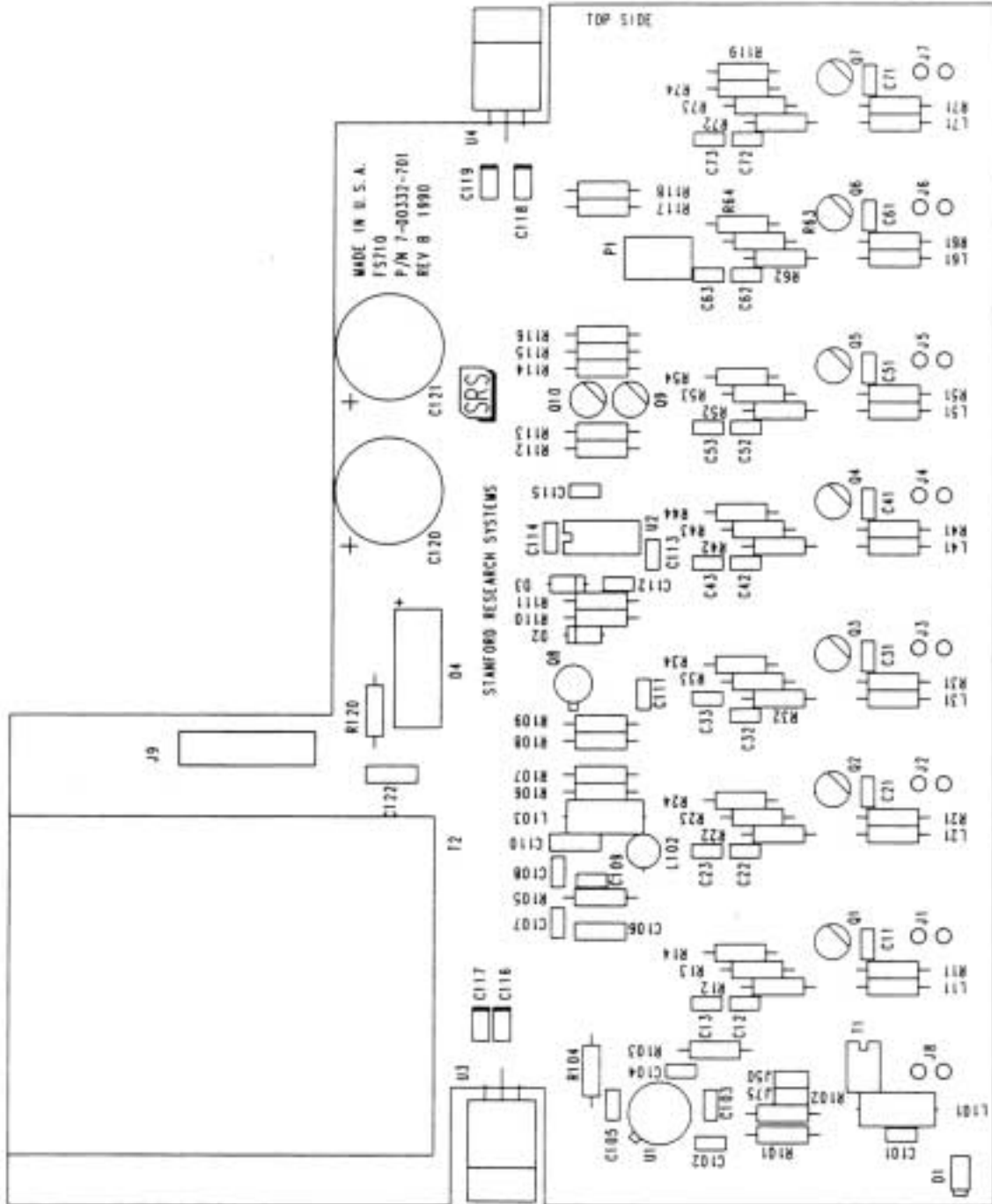

Figure 2 – FS710 PC Layout

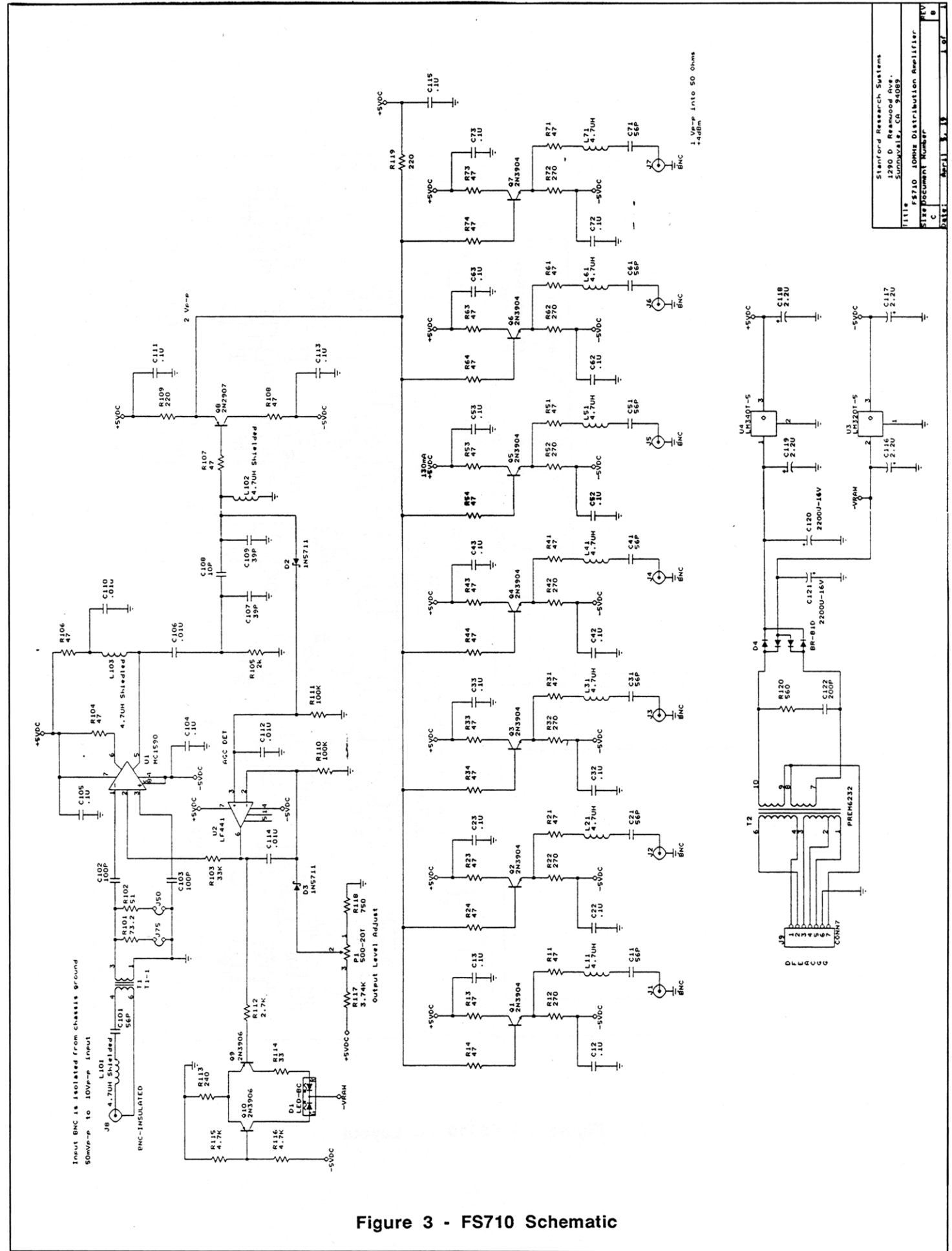

Figure 3 - FS710 Schematic



